



# Magnifi™ 5

*Getting started with Magnifi 5*

&

*Applications Guides*

Version 1.2

Date: October 2023

<b>Revision History</b>		
<b>Version</b>	<b>Description</b>	<b>Date</b>
1.0	Original document	November 2022
1.1	Modifications to the RFA section	December 2022
1.2	Addition of the option to hide indications in the SMART Setup Tools sections Modification to the report sections (.html format)	October 2023

## Contents

Magnifi 5 Overview .....	9
Introducing Magnifi 5 .....	10
Backstage Overview .....	10
Front Stage Overview .....	11
Strip Chart View .....	13
Lissajous View .....	14
Voltage Plane View .....	16
Code View .....	18
Info View .....	19
C-Scan and 3D C-Scan Views .....	20
A-scan UT .....	21
Projection .....	22
Operating Magnifi 5 .....	24
Backstage Details .....	25
ECT Application Guide .....	50
Introduction .....	52
Equipment .....	52
Project and inspection files .....	54
Setup wizard .....	57
Smart Setup Tools .....	77
Data List .....	99
Performing an acquisition .....	101
Visualizing the data .....	102
Calibration and sizing curves .....	106
Inspection .....	111
Loading a file .....	114
Report .....	115
DefHi™ Application Guide .....	120
Introduction .....	122

Project and inspection files .....	124
Setup wizard .....	126
Smart Setup Tools.....	145
Data list.....	160
Performing an acquisition .....	162
Visualizing the data.....	164
Calibration and sizing curves .....	168
Inspection .....	174
Loading a file.....	178
Report .....	179
RFT Application Guide.....	183
Introduction.....	185
Equipment .....	185
Project and inspection files .....	187
Setup wizard .....	190
Smart Setup Tools.....	210
Data list.....	226
Performing an acquisition .....	228
Visualizing the data.....	229
Calibration and sizing curves .....	234
Inspection .....	245
Loading a file.....	250
Report .....	251
Appendix 1 – Voltage plane.....	255
RFA Application Guide .....	258
Introduction.....	259
Equipment .....	259
Project and inspection files .....	261
RFA Setup wizard.....	263
Setup Modifications.....	278

Data List .....	278
Performing an Acquisition .....	280
Visualizing the data.....	282
Setup Adjustment.....	290
Performing an Inspection .....	308
Report .....	310
Advanced Settings and Operations .....	315
Limitations .....	338
Appendix 1 – Voltage plane.....	339
Appendix 2 – Periodic Noise Filter.....	342
NFT Application Guide .....	347
Introduction.....	349
Equipment .....	349
Project and inspection files .....	351
Setup wizard .....	354
Smart Setup Tools.....	371
Data list.....	386
Performing an acquisition .....	388
Visualizing the data.....	390
Calibration and sizing curves .....	393
Inspection .....	397
Loading a file.....	401
Report .....	402
NFA Application Guide.....	406
Introduction.....	408
Equipment .....	408
Project and inspection files .....	409
Setup wizard .....	412
Smart Setup Tools.....	431
Data list.....	446

Performing an acquisition .....	448
Visualizing the data.....	450
Calibration and Sizing Curves .....	454
Inspection .....	459
Loading a file.....	463
Report .....	464
MFL Application Guide.....	468
Introduction.....	470
Equipment .....	470
Project and inspection files .....	472
Setup wizard .....	475
Smart Setup Tools.....	492
Data list.....	507
Performing an acquisition .....	509
Visualizing the data.....	510
Calibration and sizing curves .....	514
Inspection .....	518
Loading a file.....	522
Report .....	523
IRIS Application Guide.....	527
Introduction.....	529
Terminology.....	529
Equipment .....	530
Project and inspection folders.....	533
Setup wizard .....	536
Data list.....	544
Hardware Assembly.....	546
Performing an acquisition .....	549
Inspection .....	560
Loading a file.....	561

Report .....	561
ECA Application Guide .....	566
Introduction .....	567
Quick probe selection guide .....	567
Probes description .....	572
Setup .....	575
Layout .....	579
Operating frequency selection .....	581
Calibration .....	584
Acquisition .....	595
Maintenance .....	596
Sharck™ G2 Application Guide .....	597
Probe Description .....	598
Material compatibility .....	602
Magnifi setup .....	603
Data management .....	604
Layout .....	606
Probe calibration .....	607
Acquisition .....	609
Analysis .....	611
Maintenance .....	619
Encoder calibration .....	621
Sharck™ Pencil G2 Application Guide .....	623
Probe Description .....	624
Material compatibility .....	624
Setup .....	625
Data Management .....	625
Layout .....	627
Probe calibration .....	628
Acquisition .....	629

Analysis .....	630
Maintenance.....	634
Sharck-HR Application Guide .....	635
Probe Description .....	636
Material compatibility .....	638
Magnifi setup.....	638
Data management .....	639
Layout .....	641
Probe calibration .....	642
Acquisition .....	643
Analysis .....	644
Maintenance.....	653
Encoder calibration.....	654



# Magnifi 5 Overview

## INTRODUCING MAGNIFI 5

The Ectane™ instrument is operated by Magnifi, a powerful and easy-to-use acquisition and analysis software. It is designed for a wide range of nondestructive testing techniques dedicated to tubing and surface inspections and relies on intuitive wizards to configure setups.

Magnifi has a graphical user interface (GUI) designed to simplify the inspection process and enhance your experience. Through the GUI, all the functions associated to **inspection project management**, the **global settings**, and the **preferences** are in what is referred to as the **backstage** view. All inspection work, calibration, acquisition, and analysis is in what is referred to as the **front stage** view. This is how Magnifi offers a streamlined and coherent interface that makes the learning process easy.

## BACKSTAGE OVERVIEW

At the opening of Magnifi, the backstage view is displayed. It is composed of nine sections that supply different information.

The default section and first section of the backstage view is the **General** section, which contains information about:

- Probe currently connected to Ectane
- Selected project and inspection folders
- Currently loaded setup and data

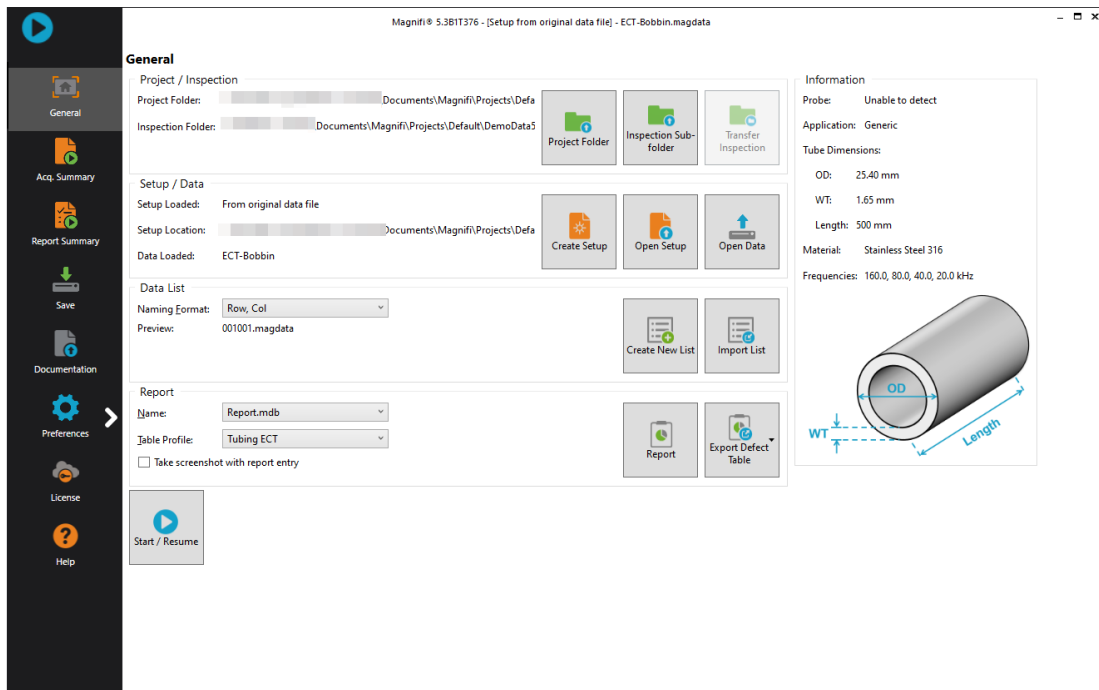

This is also where you:

- Create or open a project folder
- Create, open or transfer an inspection sub-folder
- Create or open a setup
- Open data
- Select the file naming format
- Create or import a list of file names
- Choose the report table profile and automatic screen capture option
- Generate a report or export the defect table

Under many circumstances, this is the only section that is needed to manage inspection projects.

Other sections of the backstage are described below.

## FRONT STAGE OVERVIEW

The front stage displays all the information about your current inspection. This is where you will find all the tools to acquire, save and analyze inspection data.

Continue reading the following sections of the document for additional information on the available tools and functions.

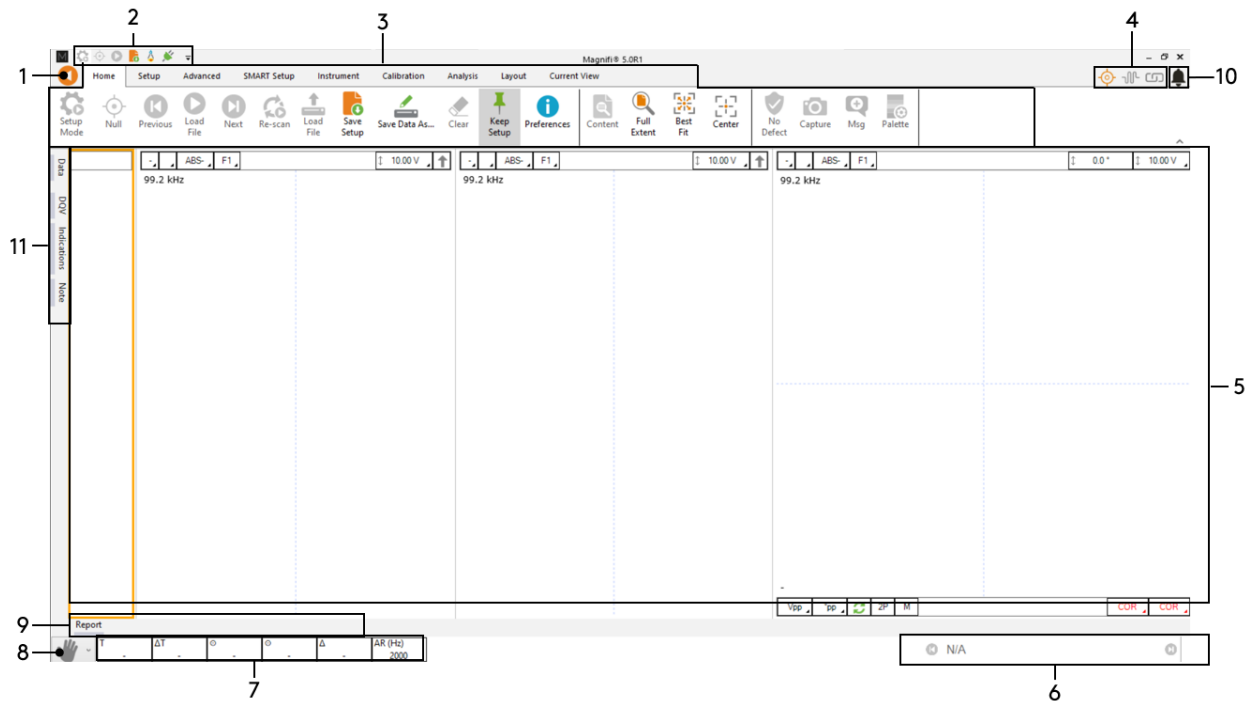

1. Backstage icon

7. Information

Click to access to backstage view.

**2. Quick access toolbar**

Customizable toolbar to provide access to the commands you use the most often.

**3. Ribbon-style menus**

These nine menus allow you to perform several inspection operations.

**4. Status icons**

These icons convey unit status information graphically.

**5. Data display area**

This area is where you will see the inspection data.

**6. File navigator**

Use the file navigator to open and display files in the data area. An alternative method would be to use the data tab (see 10).

This area displays information about cursor position, measurements and acquisition parameters.

**8. Keyboard arrow mode selector**

Click to change the operational mode of the keyboard arrows.

**9. Information tabs**

Click on the tabs to display information, documentation, or report content.

**10. Notifications**

Click on the tabs to display the notifications.

**11. Data tabs**

Click on the tabs to display the list of data, DQV tool, Screening tool and notes.Views

Views vary according to the type of probe or technology you are using. You can select layouts or set one up yourself. This section introduces the various elements of available views.

Note that some elements of a view are automatically removed when the view is resized smaller. To display all the elements of a view, increase its size until they reappear.

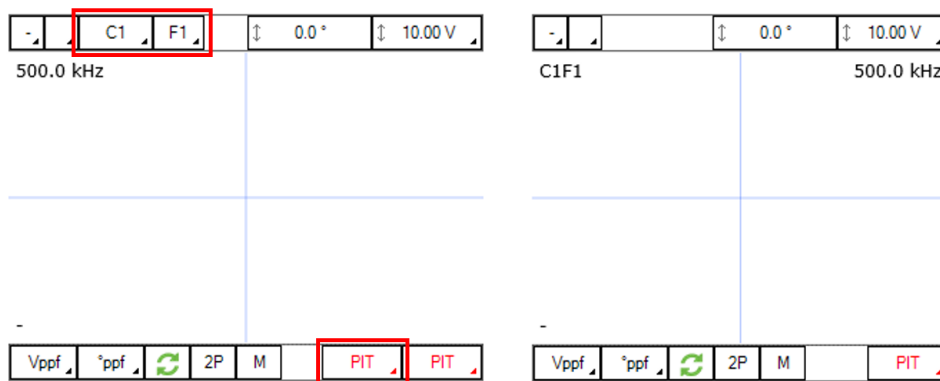

## STRIP CHART VIEW

---

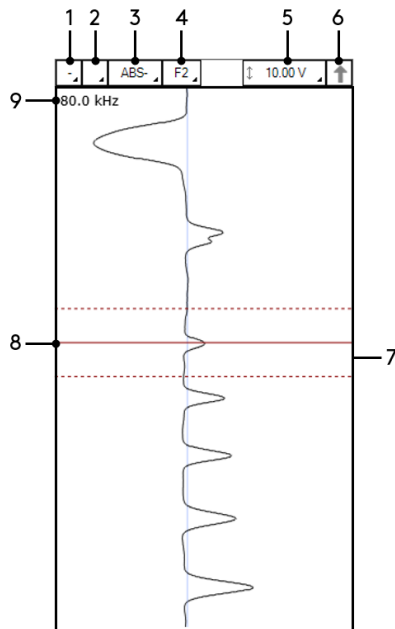

- 1. Link button**  
Views with the same number are linked. Changing the channel/C-scan or frequency of a linked view also modifies all the other linked views.
- 2. Global channel/C-scan selector**  
Regroups the channel/C-scan and frequency selectors in a single button.
- 3. Channel/C-scan group name selector**
- 4. Frequency selector**
- 5. Scale**
- 6. Signal component selector**  
Vertical arrow for the vertical component of the Lissajous or horizontal arrow for the horizontal component of the Lissajous.
- 7. Data area**
- 8. Cursor**  
Only the data within the dashed cursors are displayed in a Lissajous.
- 9. Information**  
Operating frequency.

## LISSAJOUS VIEW

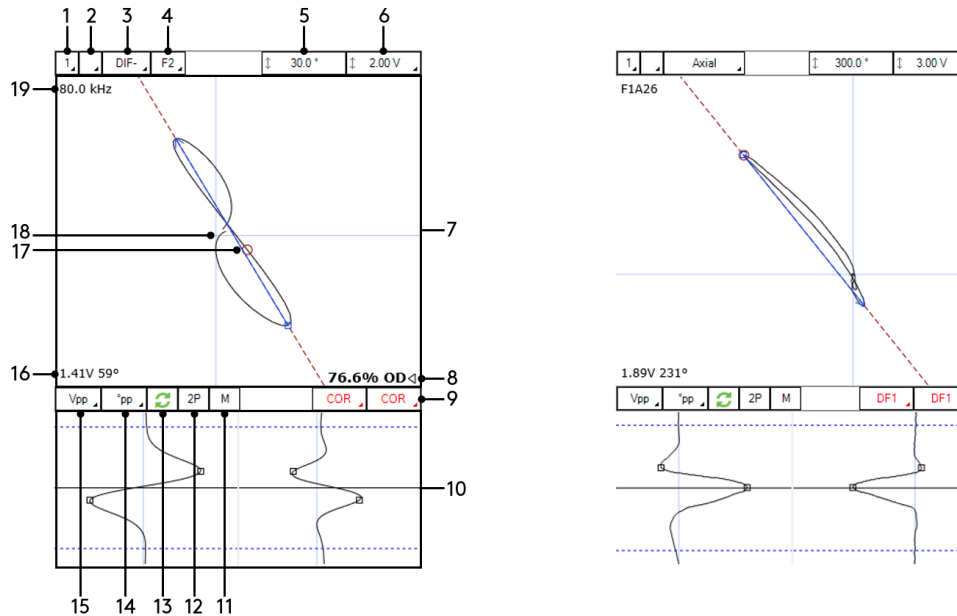

### 1. Link button

Views with the same number are linked. Changing the channel/C-scan or frequency of a linked view also modifies all the other linked views.

### 2. Global channel/C-scan selector

Regroups the channel/C-scan and frequency selectors in a single button.

### 3. Channel/C-scan group name selector

### 4. Frequency selector

### 5. Rotate

Warning: Displayed number corresponds to the Lissajous' rotation, not the signal's phase angle measurement.

### 6. Scale

### 7. Data area

Displays data located inside the cursor of the corresponding strip chart or C-scan.

### 8. Sizing measurement

Measurements available only when a sizing curve corresponding to the displayed channel has been created and calibrated.

### 9. Report/Indication codes

Click to add an indication corresponding to the selected code in the report. Long click to edit.

### 10. Mini Strip Chart area

Displays two strip charts: Vertical (left) and horizontal (right) components of the Lissajous. When mini strip charts are used, data displayed in the Lissajous corresponds to the data within the mini cursors identified with blue dashed lines.

**11. Manual measurement**

Use the mouse to manually trace a measurement vector in the Lissajous.

**12. Two-points measurement**

Activates two additional cursors in the strip chart. The measurement vector in the Lissajous is based on the data located at the position of the two cursors.

**13. Invert phase angle measurement**

Invert the direction ( $\pm 180^\circ$ ) of the measurement vector in the Lissajous.

**14. Phase angle measurement mode**

Phase measurement illustrated by the red dashed line. Automatic adjustment based on the measurement mode used.

**15. Amplitude measurement mode**

Amplitude measurement illustrated by the blue vector. Automatic adjustment based on the measurement mode used.

**16. Signal measurement result**

Based on the measurement modes used.

**17. Cursor position circle**

Red circle over data point corresponding to location of cursor in strip chart or C-scan.

**18. Null mark**

Center of the Lissajous where the two blue lines intersect. Corresponds to 0 V for both the horizontal and vertical axes.

**19. Information**

Operating frequency or array probe's channel corresponding to cursor's position on C-scan.

## VOLTAGE PLANE VIEW

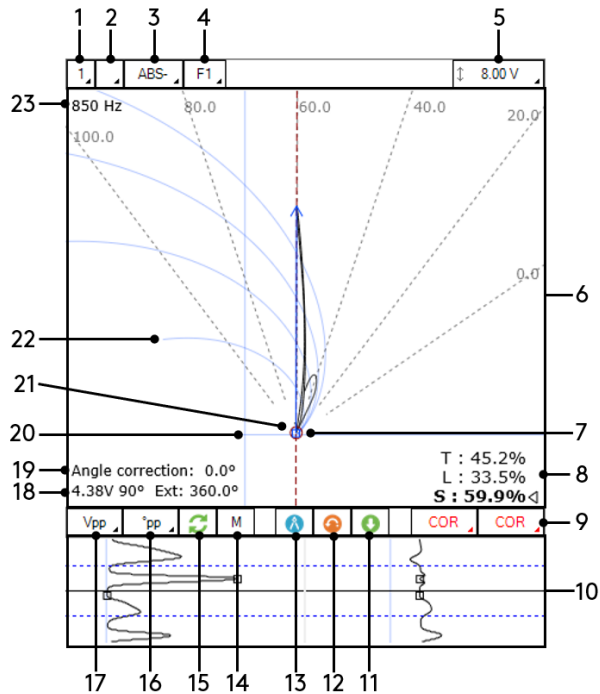

### 1. Link button

Views with the same number are linked. Changing the channel/C-scan or frequency of a linked view also modifies all the other linked views.

### 2. Global channel/C-scan selector

Regroups the channel/C-scan and frequency selectors in a single button.

### 3. Channel/C-scan group name selector

### 4. Frequency selector

### 5. Scale

### 6. Data area

Displays data located inside the cursor of the corresponding strip chart.

### 7. Cursor position circle

Red circle over data point corresponding to location of cursor in strip chart or C-scan.

### 8. Sizing measurement

Measurements available only when a sizing curve corresponding to the displayed channel has been created and calibrated.

### 9. Report/Indication codes

Click to add an indication corresponding to the selected code in the report. Long click to edit.

### 10. Mini Strip Chart area



Displays two strip charts: Vertical (left) and horizontal (right) components of the Lissajous. When mini strip charts are used, data displayed in the Lissajous corresponds to the data within the mini cursors identified with blue dashed lines.

**11. Save nominal**

Saves the current adjustment to the nominal value.

**12. Back to nominal**

Returns the signal back to the nominal point previously stored using the button "Save nominal".

**13. Normalize signal**

Normalizes the displayed signal. Brings the cursor position circle data point to the (1,0) position.

**14. Manual measurement**

Use the mouse to manually trace a measurement vector in the Lissajous.

**15. Invert phase angle measurement**

Invert the direction ( $\pm 180^\circ$ ) of the measurement vector in the Lissajous.

**16. Phase angle measurement mode**

Phase measurement illustrated by the red dashed line. Automatic adjustment based on the measurement mode used.

**17. Amplitude measurement mode**

Amplitude measurement illustrated by the blue vector. Automatic adjustment based on the measurement mode used.

**18. Signal measurement result + Circumferential extent of the indication**

Signal measurement result based on the measurement modes used. Circumferential extent based on flaw coverage curves (see 22).

**19. Angle correction**

Displayed with red font if angle correction is outside of accepted tolerance.

**20. Null mark**

Center of the Lissajous where the two blue lines intersect. Corresponds to 0 V for both the horizontal and vertical axes.

**21. Theoretical nominal point**

Corresponds to the intersecting point of the flaw coverage curves.

**22. Flaw coverage curves**

From bottom to top:  $90^\circ$ ,  $180^\circ$ ,  $270^\circ$  and  $360^\circ$ .

**23. Information**

Operating frequency.

## CODE VIEW

---

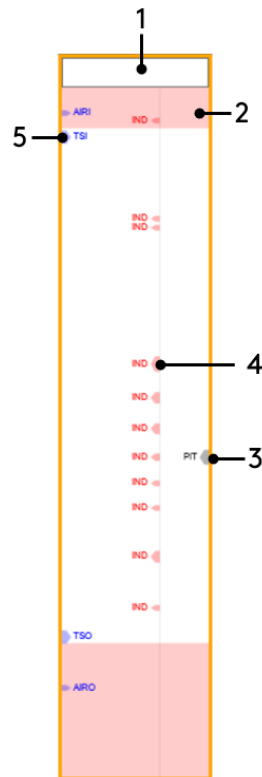

### 1. Header

No channel/C-scan/frequency selector in the header of a code view. It regroups together information coming from all the channels. Position of indications in the code view are directly related to positions in strip charts.

### 2. Saturation

Red background in the code view indicating that signal is saturated. Often happens when the probe gets in the air.

### 3. Reported indications

Position and width of the marks corresponding to position and width of the cursor when indications were added. Clicking on an indication in the code view automatically moves and resizes the cursor to match this indication.

### 4. Detected indications

Position and width of the marks corresponding to position and width of the detected indications. Clicking on an indication in the code view automatically moves and resizes the cursor to match this indication.

### 5. Landmarks

Blue triangles pointing at the position of the landmarks. Landmarks don't have a width.

## INFO VIEW

---

The Info view displays information using large and easy to read numbers. It can be customized to display information such as:

- Cursor position on the X or Y axis, in samples or units;
- Cursor width ( $\Delta$ ) along the X or Y axis, in samples or units;
- Acquisition rate;
- Maximum probe speed;
- Measured crack's depth and length (Sharck™ probes only);
- Etc.

The outputs provided by an Info view can be different during acquisition and analysis.

The view is automatically divided into the appropriate number of individual boxes to display all the selected information.

Compensated Depth (mm)	Length (mm)	Liftoff (mm)
3.2	12.3	0.2

Center X (mm)	Delta X (mm)
292.0	49.7
Center Y (mm)	Delta Y (mm)
24.0	15.8

## C-SCAN AND 3D C-SCAN VIEWS

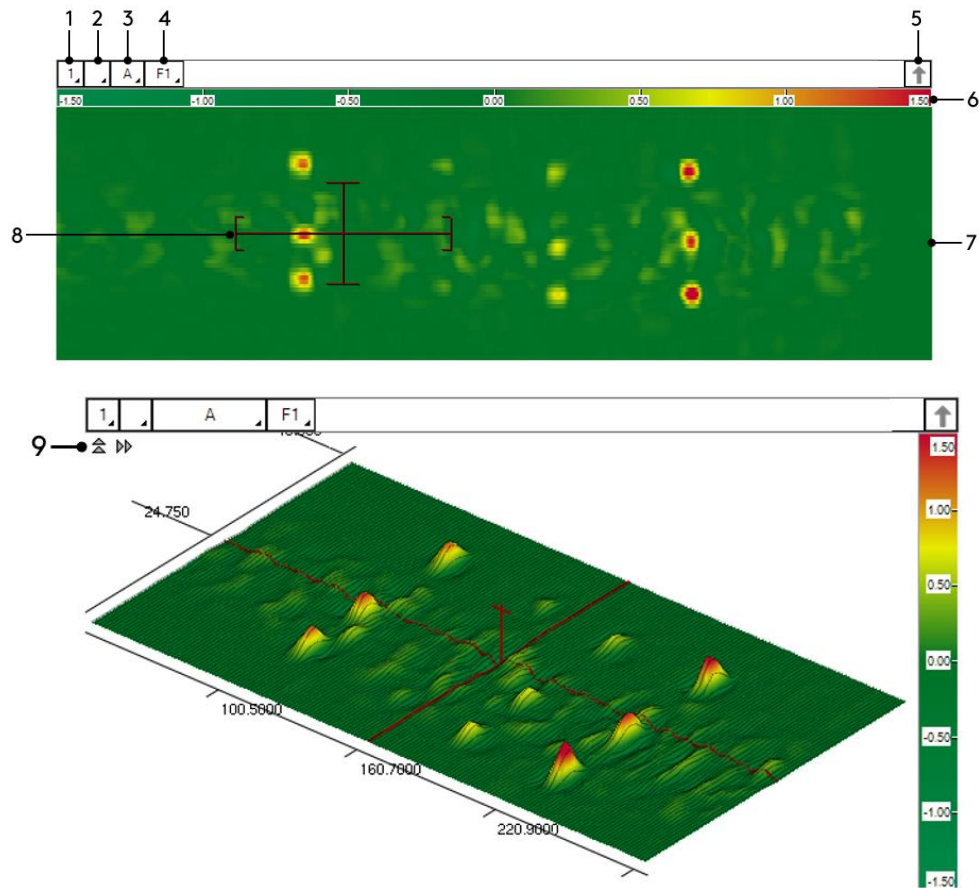

### 1. Link button

Views with the same number are linked. Changing the channel/C-scan or frequency of a linked view also modifies all the other linked views.

### 2. Global channel/C-scan selector

Regroups the channel/C-scan and frequency selectors in a single button.

### 3. Channel/C-scan group name selector

### 4. Frequency selector

### 5. Signal component selector

Vertical arrow for the vertical component of the Lissajous or horizontal arrow for the horizontal component of the Lissajous.

### 6. Color palette

Double-click or go to current view ribbon to edit.

### 7. Data area

### 8. Cursor

Only the data within the 2D C-scan cursor are displayed in a Lissajous and in the 3D C-scan.

## 9. 3D C-scan orientation

Click on the vertical or horizontal arrows to change the orientation of the 3D C-Scan.

## A-SCAN UT

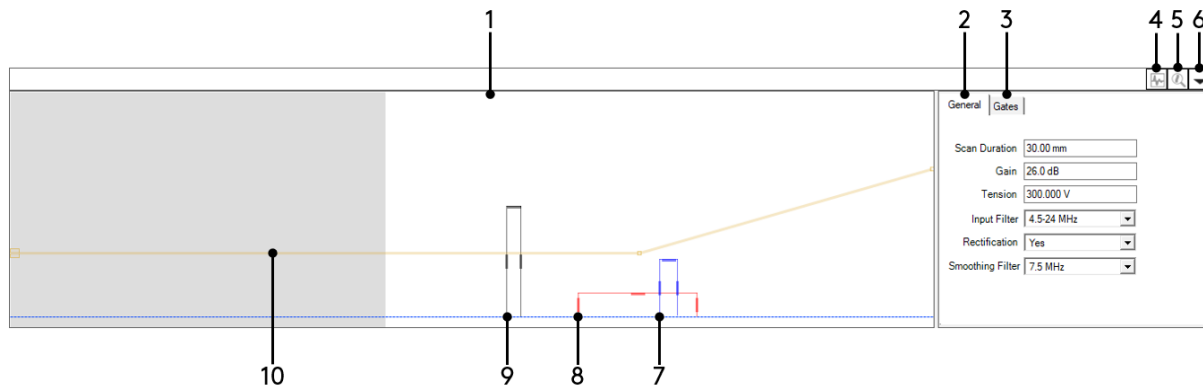

### 1. A-scan data area

### 2. General tab

Regroups general information that can be modified by the user, such as the scan duration, the tension, the filters, etc.

### 3. Gates tab

Regroups information about the positions and dimensions of the gates. Also, contains fields to adjust the TCG. Fields can be modified by the user.

### 4. Envelop

Click to activate the persistence of the data on the screen. To clear the cumulated data from the screen, disable the envelop option.

### 5. A-scan back wall

Zooms on the front wall and back wall portions of the data to make it possible to adjust the back wall.

### 6. Show/Hide A-scan UT view

### 7. Back wall gate

Blue outlined box. Use the mouse to adjust the position and dimensions. Alternatively, the gates tab can be used.

### 8. Front wall gate

Red outlined box. Use the mouse to adjust the position and dimensions. Alternatively, the gates tab can be used.

### 9. Pin gate

Black outlined box. Use the mouse to adjust the position and dimensions. Alternatively, the gates tab can be used.

### 10. Gain

Identified by the yellow line. Flat portion is the static gain. Angled portion is the Time Compensated Gain (TCG). Use the mouse to adjust the position and dimensions. Alternatively, the tabs on the right can be used.

## PROJECTION

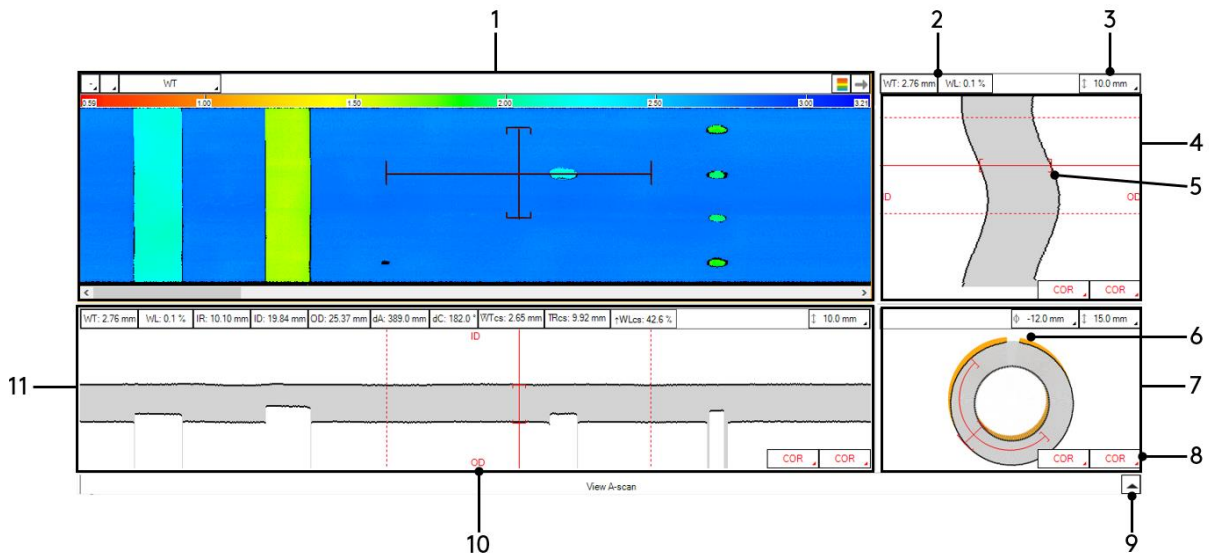

### 1. C-scan view

For additional information, see the previous section dedicated to the C-scan view.

### 2. Infofields

Customizable infofields providing information such as the wall thickness, the wall loss, etc. Fields can be added/removed.

### 3. Scale

### 4. Circumferential projection view

### 5. Cursor's brackets

Automatically adjust to the wall thickness at the location of the cursor. Can be manually adjusted using the mouse if necessary.

### 6. Nominal

Yellow portion showing the nominal dimensions of the tube.

### 7. Cylindrical projection view

### 8. Report/Indication codes

Click to add an indication corresponding to the selected code in the report. Long click to edit.

### 9. Show/Hide A-scan UT view

### 10. ID/OD

Identification of the OD and the ID of the tube in the Circumferential and Longitudinal projection views.

### **11. Longitudinal projection view**

# Operating Magnifi 5



## BACKSTAGE DETAILS

The intent of the following pages is to highlight several key features and important details about each section of the backstage in order to provide guidance and helpful information to the users of Magnifi 5.

### GENERAL SECTION

Magnifi 5.3BIT376 - [Setup from original data file] - ECT-Bobbin.magdata

**General**

Project / Inspection

Project Folder: Documents\Magnifi\Projects\Defa

Inspection Folder: Documents\Magnifi\Projects\Default\DemoData5

Project Folder    Inspection Sub-folder    Transfer Inspection

Setup / Data

Setup Loaded: From original data file

Setup Location: Documents\Magnifi\Projects\Defa

Data Loaded: ECT-Bobbin

Create Setup    Open Setup    Open Data

Data List

Naming Format: Row, Col

Preview: 001001.magdata

Create New List    Import List

Report

Name: Report.mdb

Table Profile: Tubing ECT

Take screenshot with report entry

Report    Export Defect Table

Start / Resume

**Information**

Probe: Unable to detect

Application: Generic

Tube Dimensions:

OD: 25.40 mm

WT: 1.65 mm

Length: 500 mm

Material: Stainless Steel 316

Frequencies: 160.0, 80.0, 40.0, 20.0 kHz

OD    WT    Length

### PROJECT AND INSPECTION

Project / Inspection

Project Folder: C:\Users\rousseau-cyr\Documents\Magnifi\Projects\Default

Inspection Folder: C:\Users\rousseau-cyr\Documents\Magnifi\Projects\Default\Default

Project Folder    Inspection Sub-folder    Transfer Inspection

Magnifi offers a two-level folders structure to stay organized. The higher-level folder is called the **Project**. The second-level folder, or sub-folder, is called the **Inspection**. The **Project** folder simply regroups together **Inspection** sub-folders that are related in some ways.

For instance, a **Project** folder could be created for all the inspections to be performed during a refinery shutdown. Each **Inspection** sub-folder could focus on a specific asset or component of the refinery. All the files used and produced for a given **Inspection** are stored within the **Inspection** sub-folder.

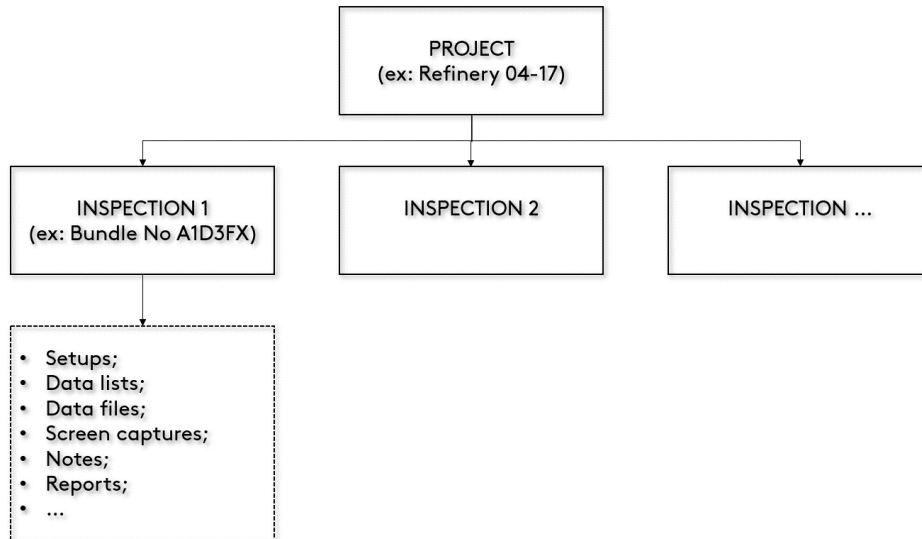

The **Project** folder and **Inspection** sub-folder buttons open windows allowing you to add new folders or browse and select existing ones.

A **Default** Inspection sub-folder gets automatically created when the **Project** folder is selected. This **Default Inspection** sub-folder can't be deleted or renamed.

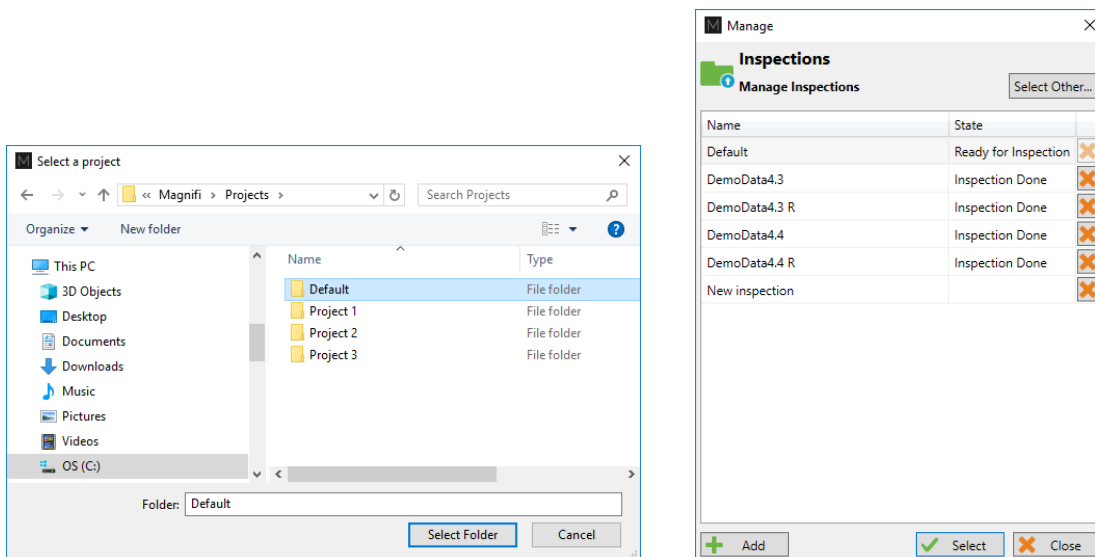
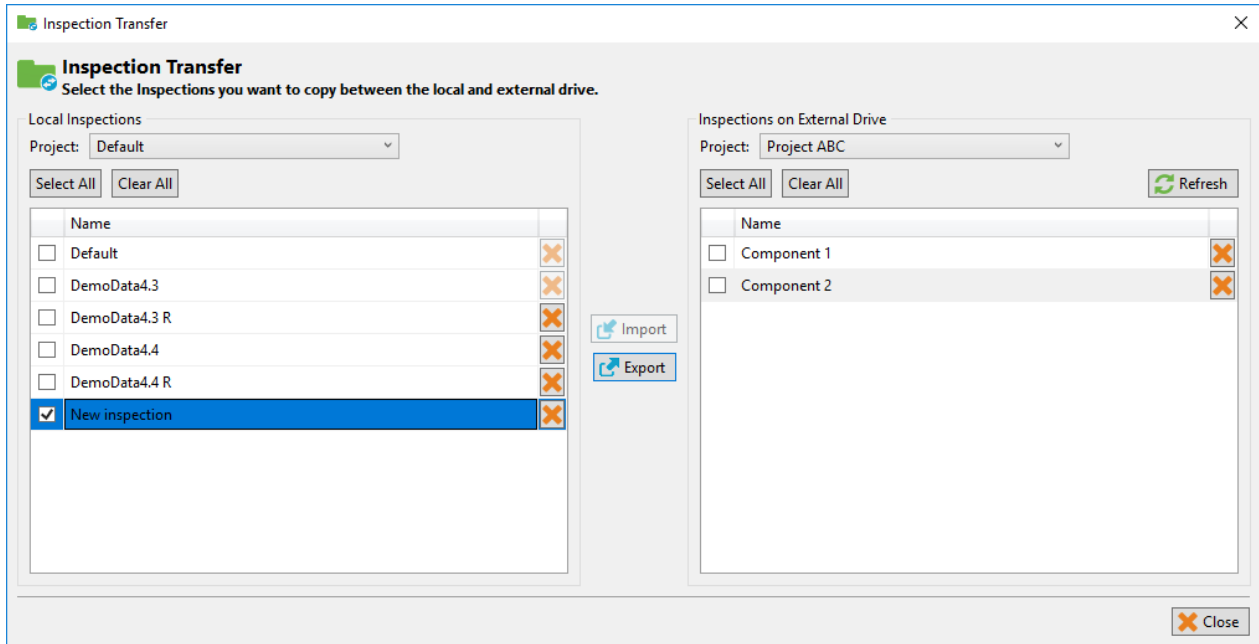

Figure 1 Project / Inspection management windows

The **Transfer Inspection** button is available only when an external drive is connected to the computer. This button allows you to transfer **Inspection** folders with all their content between the local drive and the external drive. The **Inspections** are transferred to the **Project** folder selected with the drop-down

menu. In the figure below, clicking on **Export** would copy the local **Inspection** called New inspection in the **Project** called Project ABC located on the external drive.



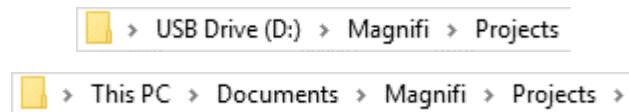

Note that the **Project** folders that are detected and displayed in the **Project** drop-down menus must be located at the following directories:



## SETUP AND DATA

Setup / Data	
Setup Loaded:	From original data file
Setup Location:	C:\Users\orousseau-cyr\Documents\Magnifi\Projects\Default
Data Loaded:	PSBC0708-001

  
Create Setup

  
Open Setup

  
Open Data

A new setup can be created by clicking on the **Create Setup** button, which will guide the user through a step-by-step process that differs for each inspection technique.

The **Open Setup** button is used to retrieve an existing setup from different locations such as the **Master List** (user-configured), the **Default Master List** (installed with the software, can't be modified) or from the **Inspection** sub-folders contained in the current **Project** folder. Another option is to click on the **Select Other...** button to browse on your computer.

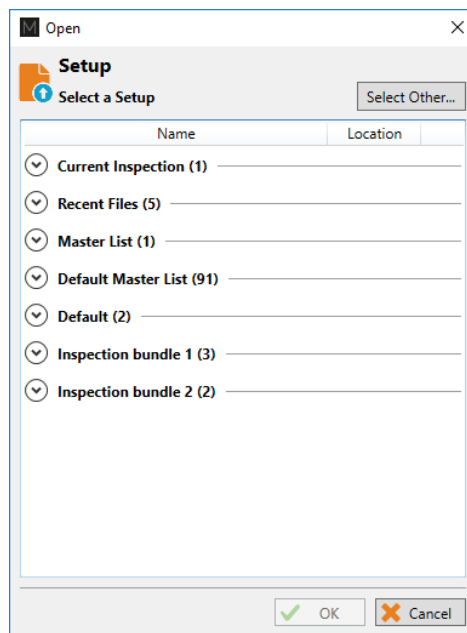

The **Open Data** button allows you to load a data file from the current **Inspection** sub-folder. It is also possible to browse on your computer to load a data file in a different location. The location of the loaded file will become the current **Inspection** sub-folder.

## DATA LIST

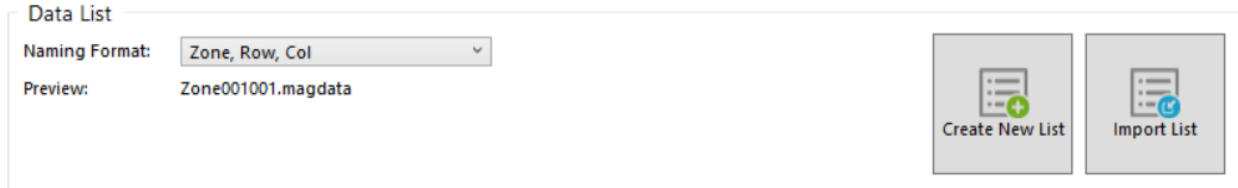

Data List

Naming Format: **Zone, Row, Col**

Preview: Zone001001.magdata

Create New List Import List

Four options are available to configure the file naming format:

- 1. Free format:**  
Each file has a custom name. Can also be defined from the Data tab of the Front Stage.
- 2. Prefix:**  
The file name includes a defined prefix followed by a sequential number.
- 3. Row, Col:**  
Row number, Column number. Mostly used for heat exchanger tubing inspections.
- 4. Zone, Row, Col:**  
Zone number, Row number, Column number. Mostly used for heat exchanger tubing inspections.
- 5. Custom:**  
Allow you to create a custom file format with other properties than the ones presented above. A new property can be customized by choosing its name, by adding a default prefix or a suffix or by selecting its type (Number or Text). All the parameters that can be changed are shown in the following figure.

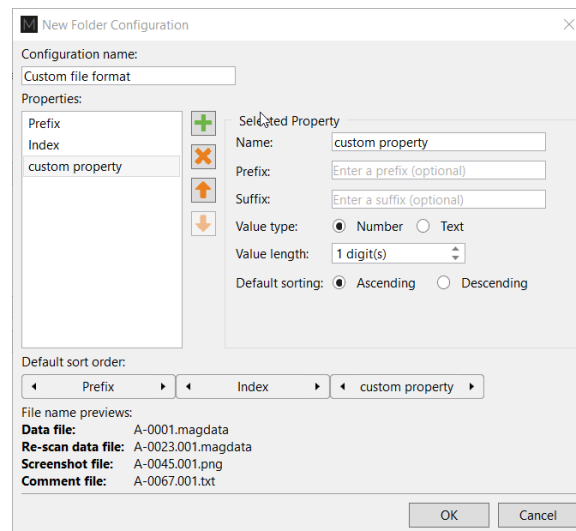

New Folder Configuration

Configuration name:

Custom file format

Properties:

Prefix  
Index  
custom property

Selected Property

Name: custom property

Prefix: Enter a prefix (optional)

Suffix: Enter a suffix (optional)

Value type:  Number  Text

Value length: 1 digit(s)

Default sorting:  Ascending  Descending

Default sort order:

Prefix Index custom property

File name previews:

**Data file:** A-0001.magdata  
**Re-scan data file:** A-0023.001.magdata  
**Screenshot file:** A-0045.001.png  
**Comment file:** A-0067.001.txt

OK Cancel

For improved productivity, the names of the files to be acquired can be generated prior to the inspection by using the **Create New List** button. Several different lists can be added in the same **Inspection**.

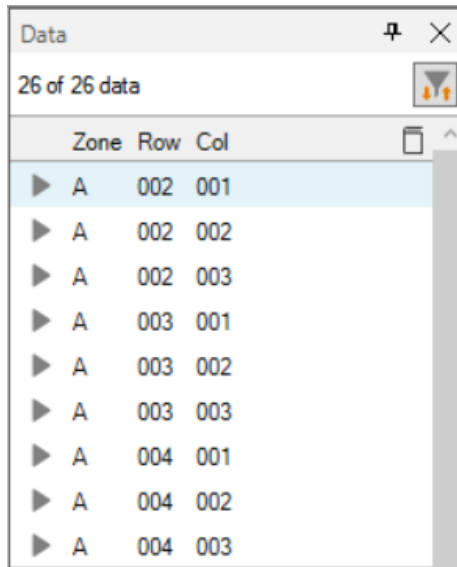
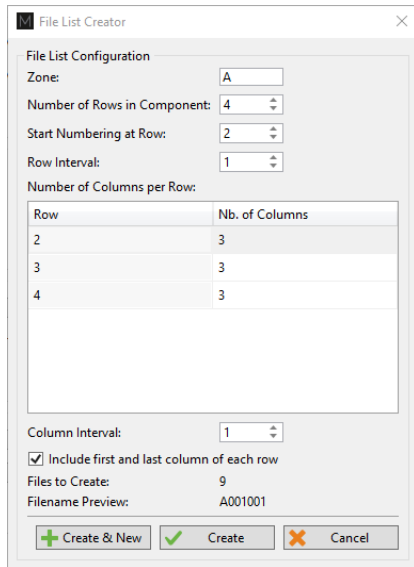

A complete **List** can be imported from a different **Inspection** folder by clicking on the **Import List** button. Note that the complete **List** of files of an **Inspection** is automatically stored in a file called **FolderDescription.xml**, located in the **Inspection** folder.

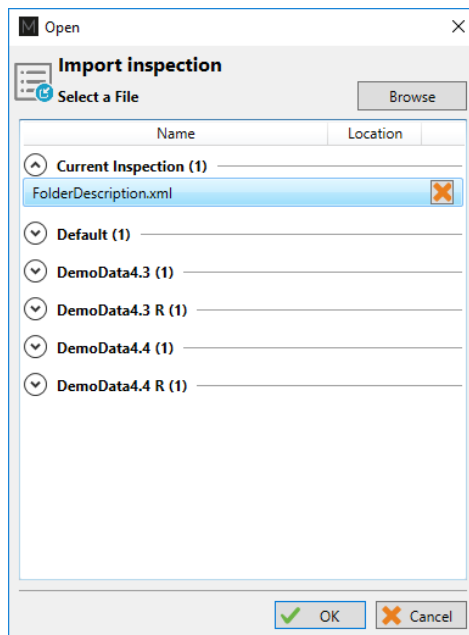

It is also possible to import a **List** created in the **TubePro™** software, which is directly available from **Eddyfi™**.

## REPORT

Report

Name:

Table Profile:

Take screenshot with report entry

A selection of several defect table profiles to be displayed in the report can be selected from the **Table Profile** drop-down menu. The information displayed in each profile is adapted to a specific inspection technique.

Once the analysis of a data set is completed, the **Generate Report** button can be used to produce a report. A few report parameters can be configured, such as the **# of tube in component**, which is used to show the percentage of tubes in each category. Additional customization of the report's header, such as the company logo, can be done through other sections of the backstage. Continue reading for more information.

**Generate Report**

**Report Parameters**  
Tube project parameters

# of tubes in component: 50

**Generate Report**

**Report Summary**  
Configure the Summary Section

Client: <enter value>

Component Type: <enter value>

Component S/N: <enter value>

Site: <enter value>

Service Provider: <enter value>

Work Order: <enter value>

Procedure: <enter value>

Calibration Standard: <enter value>

Comment

Display in File Explorer

Once generated, the report is saved as a .html file in the current Inspection sub-directory. It can be viewed using any regular web browser.

There is a "copy" button next to each element of the report such as tables and images. When clicking on it, the element will be copied to the clipboard. It can then be pasted to another file such as an Excel or Word.

**Analysis Report**

Instrument Settings 

Setup name: ECT-Bobbin

**Channels**

Name	Frequency (KHz)	Drive (V)	Gain (dB)	Low Pass (KHz)	High Pass (Cnt)
R_ABS-F1	160.0	2.50	46.0	400	
R_ABS-F2	80.0	2.50	46.0	400	
R_ABS-F3	40.0	2.50	46.0	400	
R_ABS-F4	20.0	2.50	46.0	400	
R_DIF-F1	160.0	2.50	46.0	400	
R_DIF-F2	80.0	2.50	46.0	400	
R_DIF-F3	40.0	2.50	46.0	400	
R_DIF-F4	20.0	2.50	46.0	400	

The Print button, bottom right corner on image above, can be used to either print a paper copy of the whole report or to save it as a .pdf document. The PDF generator available with the current web browser will be used.

10/10/2023 15:31 Magnif Report

**Analysis Report**

Instrument Settings

Setup name: ECT-bobbin

**Channels**

Name	Frequency (KHz)	Drive (V)	Gain (dB)	Low Pass (KHz)	High Pass (Cnt)
R_ABS-F1	160.0	2.50	46.0	400	
R_ABS-F2	80.0	2.50	46.0	400	
R_ABS-F3	40.0	2.50	46.0	400	
R_ABS-F4	20.0	2.50	46.0	400	
R_DIF-F1	160.0	2.50	46.0	400	
R_DIF-F2	80.0	2.50	46.0	400	
R_DIF-F3	40.0	2.50	46.0	400	
R_DIF-F4	20.0	2.50	46.0	400	

Imprimer 4 pages

Destination

Pages

Mise en page

Plus de paramètres

Enregistrer Annuler

From the Backstage, the **Export Report** button allows you to export only the defect table in several formats such as **Tubepro** or **CSV**.

**Take screenshot with report entry** option captures an image of the **front stage** every time an indication is added to the report. The screenshots are visible in the **Data tab** of the **front stage** and can be appended to the report.



## INFORMATION

When the computer has been connected to the Ectane through the Magnifi interface, probes with a configured chip-ID can be recognized when connected to the instrument. In that condition, the probe model will be displayed. The software will send a warning if the loaded setup is not compatible with the connected probe. Note that the appropriate setup is not automatically loaded when the probe is connected, it must be manually loaded by the user.



Also, the message **Unable to detect** could simply mean that the probe being used does not have a functional chip-ID, but it can still be used for inspection.

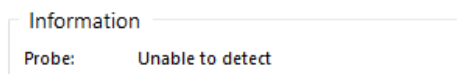

## START / RESUME

Click on the **Start / Resume** button or the **blue arrow icon** at the top-left of the **backstage** to switch to the **front stage** view.

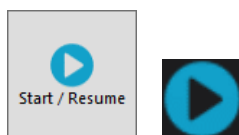

## ACQUISITION SUMMARY SECTION

This section of the **backstage** allows you to specify information related to the inspection and the inspected items such as the **component type**, the **service company**, the **operator**, the **serial number of the probe used for inspection**, etc. **This information remains attached to the data files, even if they are separated from the original Inspection folder.** Therefore, the Acquisition Summary should be filled in before data acquisition.

Note that the information can be updated at any time during an inspection to reflect the real conditions in which the data were acquired. For instance, a change of operator would ask for a modification in the **Acquisition Summary**. Therefore, all the files acquired by the new operator would be tagged correctly.

The **Acquisition Summary** is also saved with the setup file.

Fields can be added, removed and customized. Additional information can also be typed in the **Comment** section. The bottom portion of this section (**Filename, Setup, Date, Version**) is filled automatically.

Note that it is possible to import/export the **Acquisition Summary** with all the information it contains for improved productivity.

The screenshot shows the 'Acquisition Summary' form within a software application window titled 'Magnifi® 5.0R1 - ECT-Bobbin.magdata'. The form is divided into several sections:

- Component Information:** A series of five dropdown menus labeled 'Component Type', 'Site', 'Client', 'Inspector', and 'Service Provider'. Each dropdown currently displays '<enter value>' and has a small orange 'X' icon to its right.
- Comment:** A large, empty text area for entering additional information.
- Buttons:** A row of five buttons: 'Add', 'Clear', 'Reset to Default', 'Import', and 'Export'.
- Footer Information:** A section at the bottom containing four fields: 'Filename : ECT-BBST', 'Setup : CAL-Bobbin', 'Date : 4/26/2017 4:03:05 PM', and 'Version : Magnifi® 4.2R7T1'. A 'Manage...' button is located to the right of these fields.

A vertical sidebar on the left side of the window contains icons for 'General', 'Acq. Summary', 'Report Summary', 'Save', 'Material Database', 'Documentation', 'Preferences', 'License', and 'Help'. The 'Acq. Summary' icon is highlighted.

## REPORT SUMMARY SECTION

This other section of the **backstage** allows you to specify information that will appear in the header of the reports, such as the **client**, the **work order**, the **procedure**, etc.

Fields can be added, removed and customized. The fields that are grayed are linked to the **Acquisition Summary** and will be filled if the corresponding fields are filled in the **Acquisition Summary** section. Additional information can also be typed in the **Comment** section.

The **Report Summary** is saved with the setup file.

Note that it is possible to import/export the **Report Summary** with all the information it contains for improved productivity.

Magnifi® 5.0R1 - ECT-Bobbin.magdata

### Acquisition Summary

Client	<enter value>	X
Component Type	<enter value>	X
Component S/N	<enter value>	X
Site	<enter value>	X
Service Provider	<enter value>	X
Work Order	<enter value>	X
Procedure	<enter value>	X
Calibration Standard	<enter value>	X
Inspector	<enter value>	X
Analyst	<enter value>	X

Comment

Add Clear Reset to Default Import Export

Manage...

## SAVE SECTION

The **Save** section of the **backstage** proposes a few different saving options for the data files and the setup files:

- 1. Save Setup:**  
Saves the currently used setup in the current **Inspection** folder.
- 2. Save Setup as...:**  
Saves a new copy of the currently used setup and allows you to specify its name and location.
- 3. Save Setup as Read-Only...:**  
Saves a new copy of the currently used setup and allows you to specify its name and location. The file can't be overwritten. Attention, it remains possible to apply modifications to the setup while using it, however, the modifications can't be saved.
- 4. Copy Setup in Master List...:**  
Add the currently used setup to the **Master List** for a quick access from any **Inspection** folder.

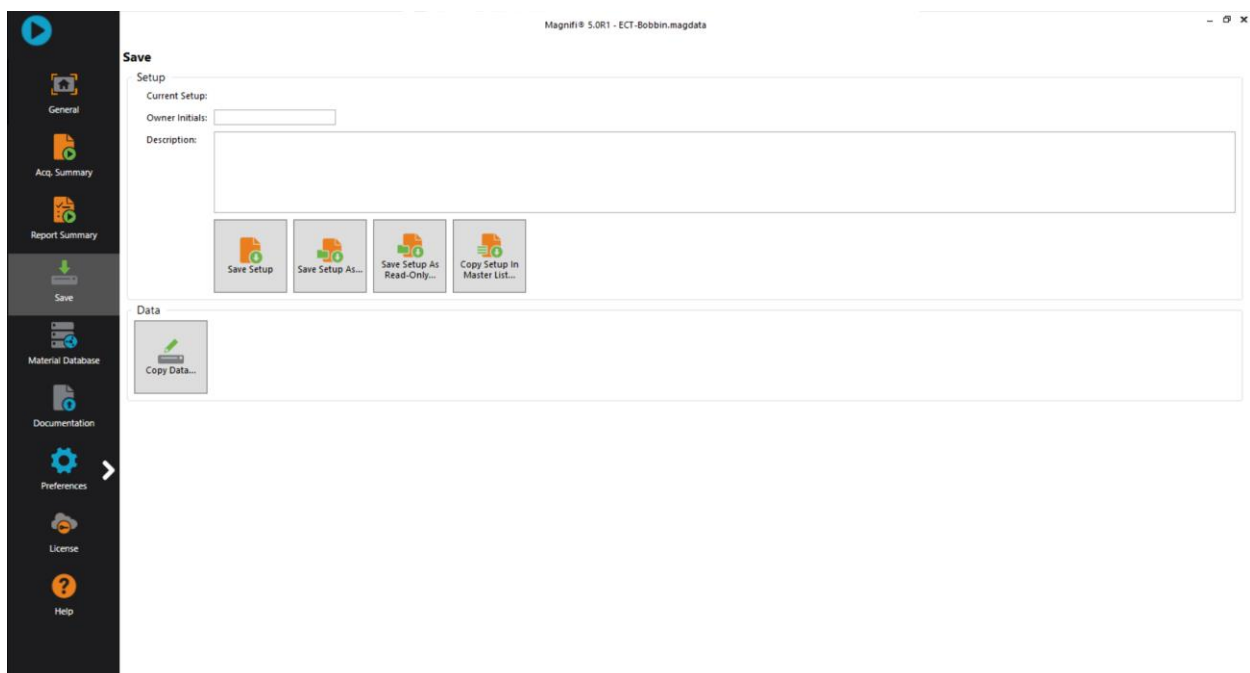

# MATERIAL DATABASE SECTION

The **Material Database** section shows a list of materials and their properties.

Three properties are associated to each material. The resistivity and the permeability are used by Magnifi to calculate the theoretical inspection frequency of the electromagnetic techniques. The ultrasonic velocity is used to preset the gates' locations when using IRIS.

**Material Database**

Custom Materials  
C:\Users\daube\AppData\Roaming\Eddyfi\Magnifi\UserMaterialsDatabase.xml

Name	Ultrasound Velocity (m/s)	Resistivity (μΩcm)	Relative Permeability
Admiralty brass	4430.000	6.9	1
Aluminum brass - ET ONLY	0.000	7.5	1
Aluminum	6320.000	2.82	1
Aluminum (6061-T-6)	6300.000	3.99	1
Aluminum bronze	3530.000	12	1
Brass (70/30)	4700.000	6.16	1
Brass (85/15) - ET ONLY	0.000	4.66	1
Brass (95/5) - ET ONLY	0.000	3.13	1
Carbon steel	5890.000	21	450
Carbon steel low-alloy Cr-Mo	5890.000	21	400
Cast iron (gray)	4600.000	16.8	125
Copper	4660.000	1.72	1
Copper nickel 70-30	4950.000	37	1
Copper nickel 90-10	4730.000	18.95	1
Copper nickel 95-05 - ET ONLY	0.000	12	1

## DOCUMENTATION SECTION

This section of the **backstage** allows you to open PDF documents. A list of documents is automatically added during the installation of Magnifi. Other documents such as codes, procedures or drawings can be added to the list by saving a copy at the following location on your computer:



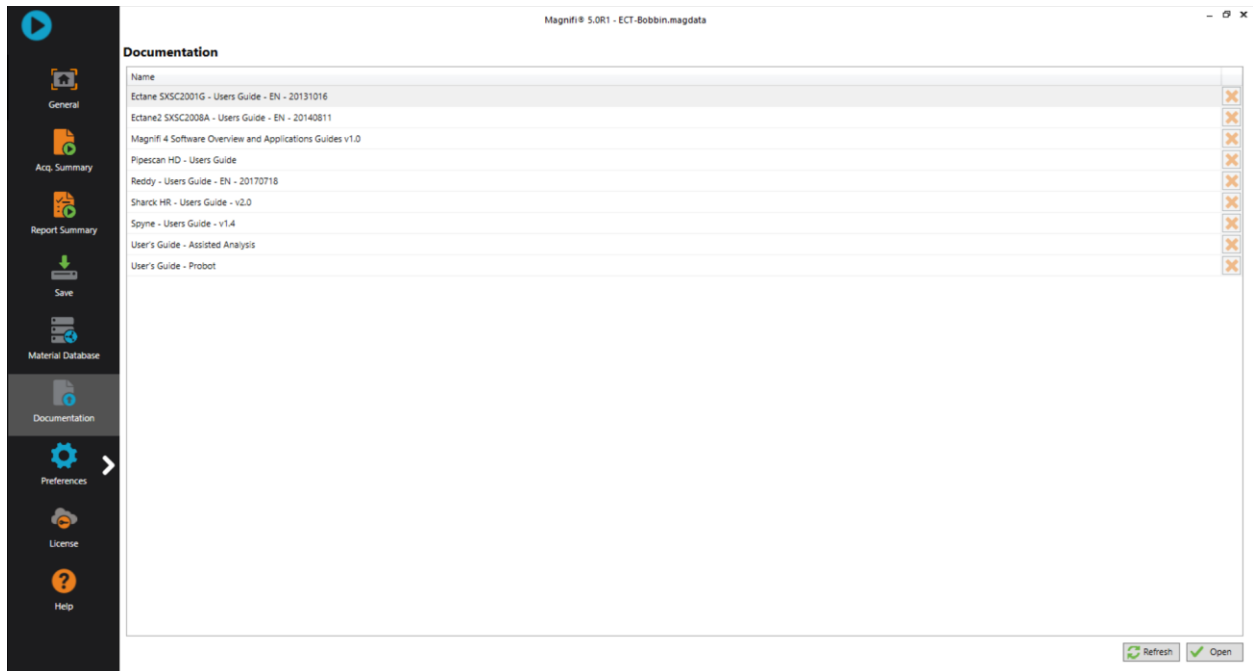

Magnifi # 5.0R1 - ECT-Bobbin.magdata

### Documentation

Name	
Ectane SKSC2001G - Users Guide - EN - 20131016	X
Ectane2 SKSC2008A - Users Guide - EN - 20140811	X
Magnifi 4 Software Overview and Applications Guides v1.0	X
Pipescan HD - Users Guide	X
Reddy - Users Guide - EN - 20170718	X
Sharck HR - Users Guide - v2.0	X
Spyne - Users Guide - v1.4	X
User's Guide - Assisted Analysis	X
User's Guide - Probot	X

Refresh Open

# SYSTEM PREFERENCES SECTION

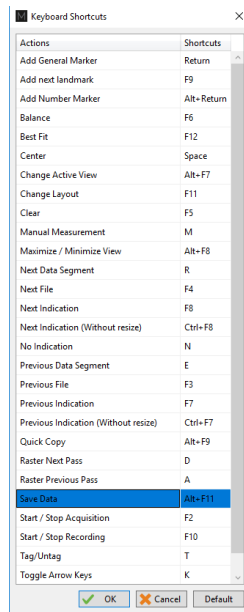
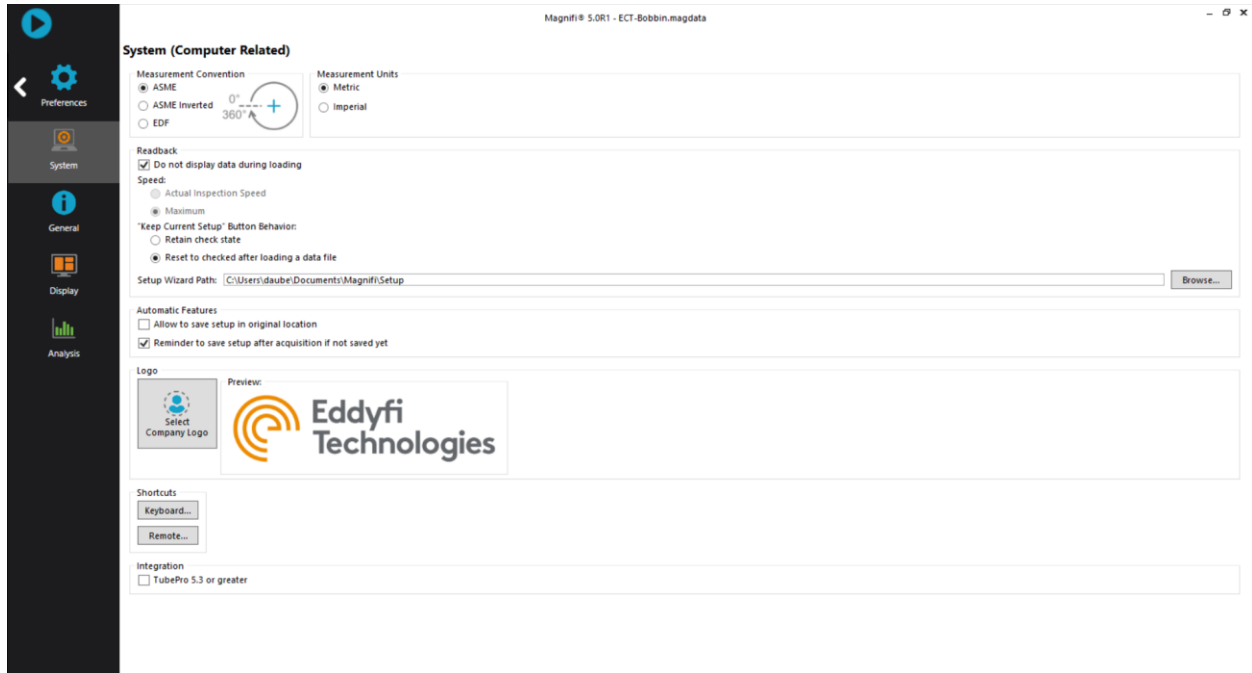

The **System Preferences** section contains several options that are related to the user's computer, meaning that the configurations will remain the same, independently of the loaded setup file.

The **Select Company Logo** button allows you to define the logo to be displayed in the header of the report. The button lets you browse your computer to select an image with any of the following formats: .bmp, .png, .jpg, .jpeg.

The list of default keyboard shortcuts available during acquisition and analysis can be visualized and managed by clicking on the **Keyboard...** button. To modify a shortcut, simply select the action in the list and press the desired key.

To integrate the TubePro software with Magnifi, check the TubePro box at the bottom of the System Preferences section.

## GENERAL PREFERENCES SECTION

The **General Preferences** section contains several options that are related to the setup, meaning that the configurations are stored with the setup when it is saved and are retrieved when the setup is loaded.

Additional information regarding some of the available options:

**1. Hide Raw Channel:**

Only the processed channels appear in the list of available channels to be displayed in the **front stage**, facilitating the analysis if the raw channels are not relevant.

**2. Automatic File Recording:**

Data recording is initiated as soon as the acquisition starts. When unchecked, a **Record** button will become available in the **front stage** during acquisition. After starting the acquisition, data is displayed on the screen, but it is not recorded until the **Record** button is pressed.

**3. Auto Create new file on Next:**

Automatically adds a new file name in the data tab of the **front stage** when clicking on the **Next** button.

**4. Automatic Next on Stop acquisition:**

Automatically skips to the next file in the list when stopping the acquisition, making the acquisition process faster.



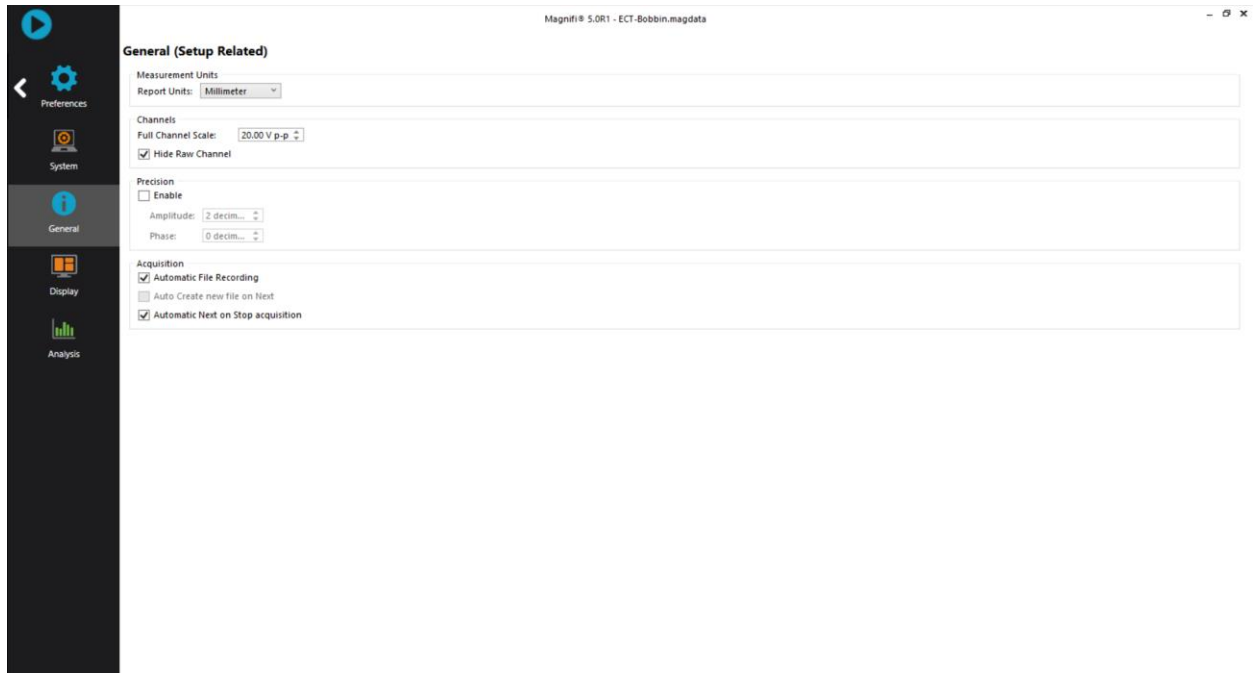

## DISPLAY PREFERENCES SECTION

The **Display Preferences** section also contains several options that are related to the setup, meaning that the configurations are stored with the setup when it is saved and are retrieved when the setup is loaded.

The **Name Splitting** options refer to the **channel/C-Scan group name selectors** displayed in the headers of the different views for easier navigation. By default, it is set to **Automatic**. The software automatically recognizes patterns in the names of the channels/C-scans and produces the appropriate selectors.

Magnifi # 5.0R1 - ECT-Bobbin.magdata

### Display (Setup Related)

Colors  
Color Scheme: Light Manage...

General Preferences  
 Display Null Mark  
Zoom Behavior on Stop Acquisition: Keep Current Scale

Lissajous  
 Display Cursor position circle  
 Display Mini Strip Charts  
Proportion: 33.00 %

Channel  
 Link C-scan Cursor with Channel:  
Display Direction: Down  
Display Duration  
 Time  Distance  Sample 10.000 s  
 Link to C-scan duration

C-scan  
 Display Grid  
X-axis: 0.00  
Y-axis: 0.00  
Scan axis scale displayed during acquisition:  
 Set Specific Scale: 0.0 mm

Name Splitting  
 Split Channel Names  
 Automatic  
 Manual: Prefix 0 Frequency 0 Channel Group 0 Coil 0  
 Split C-scan Names  
 Automatic  
 Manual: Prefix 0 Channel Group 2 Frequency 2

## ANALYSIS PREFERENCES SECTION

The **Analysis Preferences** section also contains several options that are related to the setup, meaning that the configurations are stored with the setup when it is saved and are retrieved when the setup is loaded.

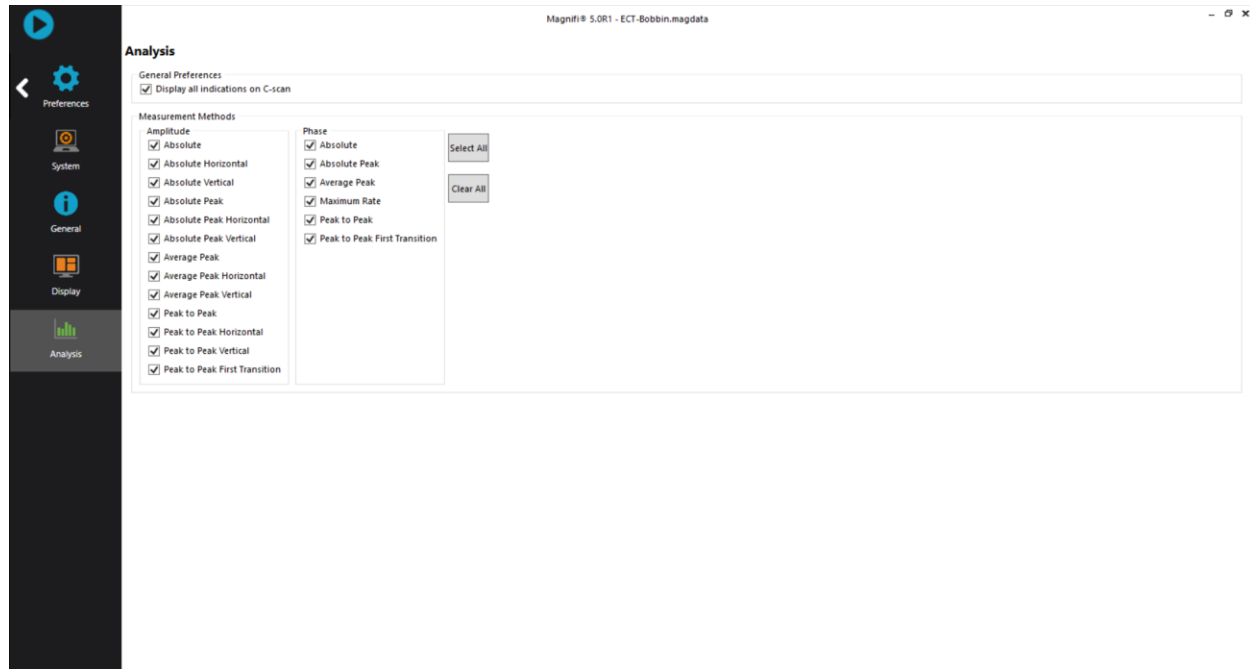

The **Measurement Methods** portion shows all the possible measurement methods that can be used by Magnifi. Only the selected methods are available for analysis, defects reporting, sizing curves, calibration, etc. It is recommended to select only the methods that are relevant to facilitate the analysis. The methods are:

- 1. Absolute (A):**  
Uses a straight line from the Lissajous origin to the main cursor position to measure amplitude.
- 2. Absolute Horizontal (AH):**  
Uses only the horizontal component, from the Lissajous origin to the main cursor position to measure amplitude.
- 3. Absolute Vertical (AV):**  
Uses only the vertical component, from the Lissajous origin to the main cursor position to measure amplitude.
- 4. Absolute Peak (AP):**  
Uses a straight line, from the Lissajous origin to the peak value of the data selection, to measure amplitude.
- 5. Absolute Peak Horizontal (APH):**  
Uses only the horizontal component, from the Lissajous origin to the peak value of the data selection, to measure amplitude.

- 6. Absolute Peak Vertical (APV):**  
Uses only the vertical component, from the Lissajous origin to the peak value of the data selection, to measure amplitude.
- 7. Average Peak (MP):**  
Takes the distances from points at the extremity of the cursor to the peak of the data selection to build an average vector. Used only, and recommended, for absolute signals.
- 8. Average Peak Horizontal (MPH):**  
Uses the horizontal component of the distances from points at the extremity of the cursor to the peak of the data selection to make an average vector. Used for absolute signals.
- 9. Average Peak Vertical (MPV):**  
Uses the vertical component of the distances from points at the extremity of the cursor to the peak of the data selection to make an average vector. Used for absolute signals.
- 10. Peak to peak (PP):**  
Uses the combination of the vertical and horizontal component to measure the maximum amplitude.
- 11. Horizontal (PPH):**  
Uses only the horizontal component to measure the amplitude.
- 12. Vertical (PPV):**  
Uses only the vertical component to measure the amplitude.
- 13. Peak to peak First Transition (PPF):**  
Uses the combination of the vertical and horizontal component of the first transition of the signal to measure maximum amplitude. The first signal transition is from the base of an indication to its peak.

## LICENCE SECTION

Magnifi 5 integrates a cloud-based licensing system to activate, release and share a license key in seconds, worldwide, without requiring assistance from Eddyfi.

To activate, manage or simply view the status and information associated with a license, launch Magnifi 5 and open the License menu by clicking on the License tab button from the backstage interface. Note that an internet connection is required to perform operations on this menu.

The screenshot shows the Magnifi 5.0R1 software interface. The title bar reads "Magnifi® 5.0R1 - [New setup.magsetup]". The interface is divided into a dark sidebar on the left and a main content area on the right. The sidebar contains several navigation icons: a play button, a home icon labeled "General", a document icon labeled "Acq. Summary", a document icon labeled "Report Summary", a download icon labeled "Save", a database icon labeled "Material Database", a document icon labeled "Documentation", a gear icon labeled "Preferences", a cloud icon labeled "License" (highlighted with a red box), and a question mark icon labeled "Help". The main content area is titled "License" and contains two sections: "Current License Information" and "Contact Information".

**Current License Information**

Status:	Valid	✓
License Code:	[REDACTED]	
Package:	PRO	
Computer ID:	[REDACTED]	
Company:	Eddyfi	
Type:	Subscription	
Last Refreshed:	July 18, 2022 1:57 PM	
Licensing System:	Connected	✓
Renewal Date:	November 01, 2022	

Buttons: Manage... Refresh

**Contact Information**





First Name:	First Name
Last Name:	Last Name
Company Name:	Eddyfi
Contact Email:	support@eddyfi.com
Phone Number:	1-418-780-1565

Button: Edit...

Once a license has been identified as valid, Magnifi can be used without any internet connection for a given period of time. Whenever an internet connection is established while using Magnifi, the software automatically contacts the cloud-based licensing system to confirm the validity of the license and reset the offline time period, without the need to access the Licence menu.

If the software remains offline for longer than the allowed time, the license will be temporarily deactivated, and it will no longer be possible to use Magnifi. To correct the situation, simply connect to the Internet and let the license system refresh.

### License

Current License Information	
Status:	Valid 
License Code:	
Package:	PRO
Computer ID:	
Company:	Eddyfi
Type:	Subscription
Last Refreshed:	July 18, 2022 3:51 PM
Licensing System:	Not Connected 
Renewal Date:	November 01, 2022
Connection to internet required by:	September 16, 2022
<input type="button" value="Manage..."/> <input type="button" value="Refresh"/>	

It is important to keep the Contact Information section of the License menu up to date, as it can be used by Eddyfi staff for assistance.

Contact Information	
First Name:	First Name
Last Name:	Last Name
Company Name:	Eddyfi
Contact Email:	support@eddyfi.com
Phone Number:	1-418-780-1565
<input type="button" value="Edit..."/>	

To Activate a license, click on the Manage... button to open the Manage License menu, type the license code in the designated field and click on the Activate button.

## License

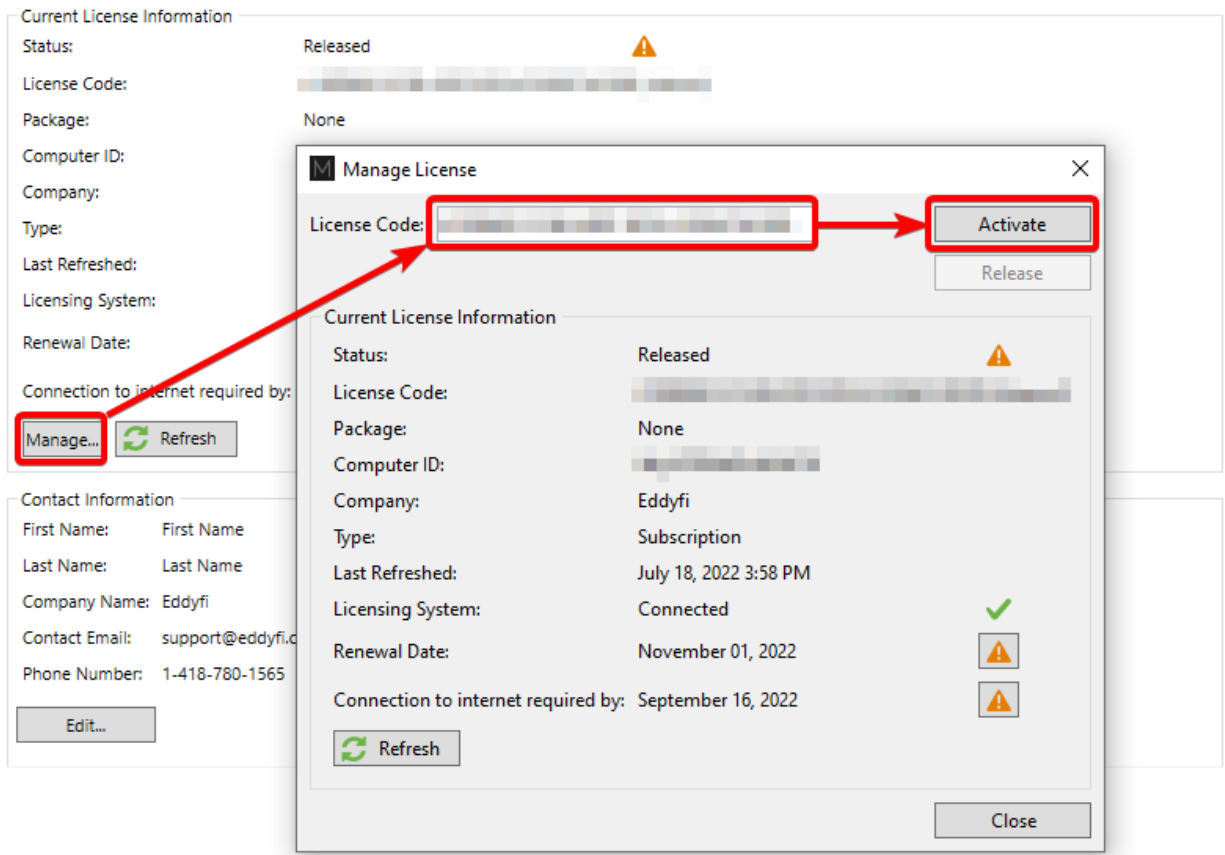

A given license code can only be activated on one (1) PC at a time. To assign a license to another PC, it must first be released from the original PC by clicking the Release button. Then the code becomes available and can be entered in the License Code field for activation in another PC. These steps make it easy to share a license between users, even if they are in different locations. They can also allow a switch to another type of license, for example from a data acquisition license to a standard analysis license.

## License

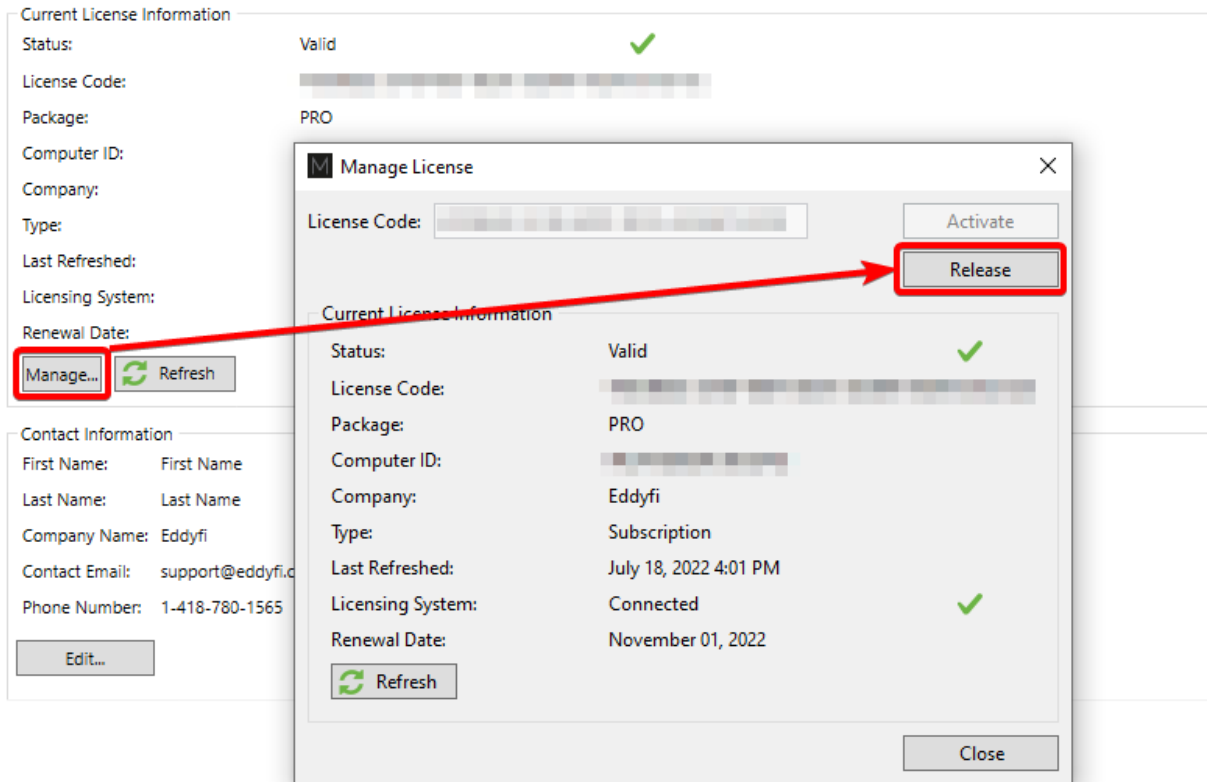

The cloud-based licensing system offered with Magnifi 5 is not compatible with Magnifi 4. Therefore, moving to the most recent version of Magnifi requires an upgrade from an existing Magnifi 4 license keys. Once upgraded, the key can no longer be used with Magnifi 4 versions.

If needed, Eddyfi can offer users the possibility to trying the newest 5.x version, while maintaining access to Magnifi 4.x using a transition license. A transition license is a Magnifi 5 key that is linked to a specific Magnifi 4 key. In this condition, Magnifi 5 will run only if both keys are connected to the computer simultaneously.

Once the transition license user feels ready to fully upgrade, the previous license key needs to be deactivated. This operation can't be reverted. A simple procedure must be followed.

Please contact your sales representative to find out the best path forward to make the most out of this licensing system.

## HELP SECTION

The last section of the **backstage** shows information about:

- The version of the software;
- The instrument currently connected to the computer;



- Eddyfi's contact information.

This is also where you can:

- Edit the privacy options;
- Get Assistance

The **Get Assistance** button allows you to send information about a problem you encounter with the software. You can first fill in the form accessible through the **Ask for help** button. If relevant, you can also use the **Export files** button to send the file associated with the problem you want to report. This information will be used to analyze the problem. Following a request an expert will contact you.

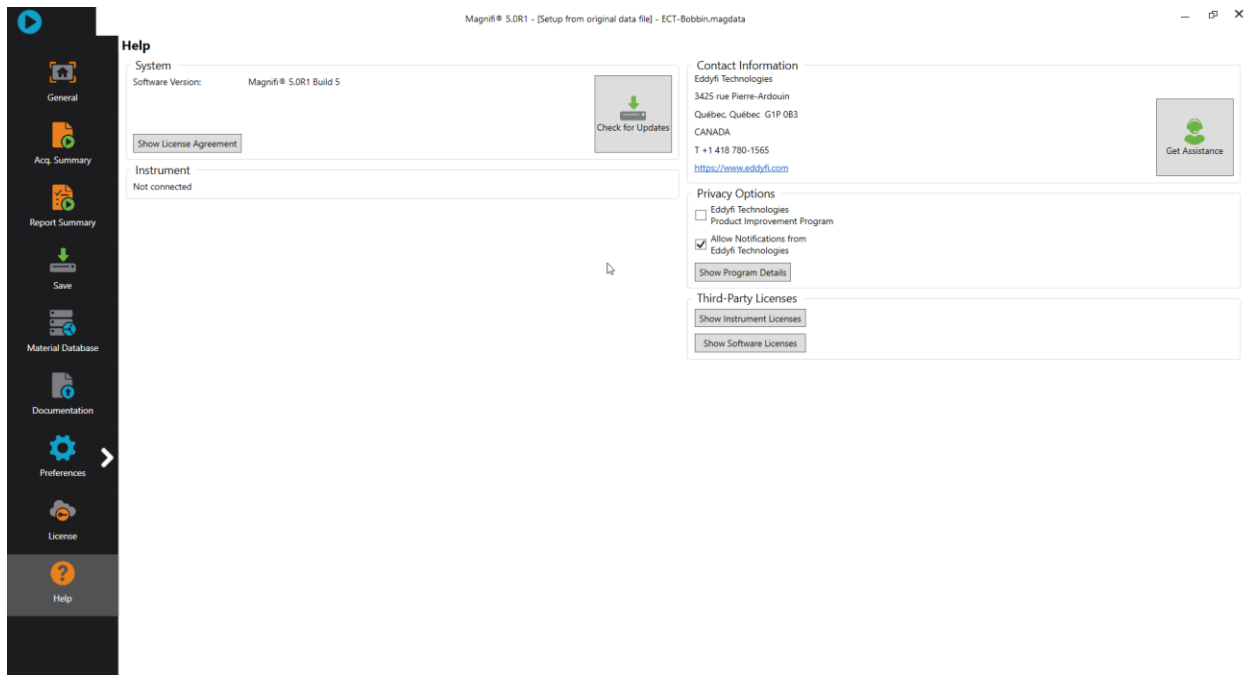

# ECT Application Guide

ECT Bobbin Probes



ECT Detachable Bobbin Probes



ECT Flexible Bobbin Probes



ECT Magnetic Saturation Bobbin Probes



## INTRODUCTION

This document presents how to use an ECT probe with Magnifi 5 on an Ectane test instrument.

Eddyfi offers four types of ECT bobbin probes. The following was made using a standard bobbin probe (ECT-BBST), but can also be applied to all other types of ECT bobbin probes.

## EQUIPMENT

ECT probes use a 4-pin connector that can be connected to an Ectane with the “E” option. The absolute and differential signal from the probe will provide Strip charts and Lissajous.

As these probes need to fill an optimal portion of the tube inner diameter, a wide range of probe diameters are offered (see the tubing probe catalog for more details). A wide range of frequencies is also available to allow inspections of tubes of different thickness and material.

From the following tables, the best standard probe for your application can be selected. Note that Eddyfi also offers custom products that are not shown in these tables.

Table 1 – ECT-BBST probes diameter selection table

		TUBE WALL THICKNESS (BWG, mm, in)															
		BWG	10	11	12	13	14	15	16	17	18	19	20	21	22	23	24
		mm	3.40	3.05	2.77	2.41	2.11	1.83	1.65	1.47	1.24	1.07	0.89	0.81	0.71	0.65	0.56
		in	0.135	0.120	0.109	0.095	0.083	0.072	0.065	0.058	0.049	0.042	0.035	0.032	0.028	0.025	0.022
TUBE OD	9.53mm	0.375in	–	–	–	–	–	–	–	–	–	–	070	072	074	076	078
	12.70mm	0.500in	–	–	–	072	078	084	088	090	096	098	102	104	106	106	108
	15.87mm	0.625in	084	090	096	104	110	114	118	122	126	128	132	134	136	136	138
	19.05mm	0.750in	114	122	126	134	140	144	148	152	156	158	162	164	166	166	168
	22.22mm	0.875in	144	152	156	164	168	174	178	180	186	188	192	194	196	196	198
	25.40mm	1.000in	174	182	186	194	198	204	208	210	216	218	222	224	224	226	228
	31.75mm	1.250in	234	238	246	255	260	265	270	275	280	280	285	285	290	290	290
	38.10mm	1.500in	295	300	310	315	320	325	330	335	340	340	345	345	350	350	350
	50.80mm	2.000in	415	420	430	435	440	445	450	455	460	460	465	465	470	470	470

Table 2 – ECT-BBST probe frequency range selection table

		TUBE WALL THICKNESS (BWG, mm, in)																
		BWG	10	11	12	13	14	15	16	17	18	19	20	21	22	23	24	
		mm	3.40	3.05	2.77	2.41	2.11	1.83	1.65	1.47	1.24	1.07	0.89	0.81	0.71	0.65	0.56	
		in	0.135	0.120	0.109	0.095	0.083	0.072	0.065	0.058	0.049	0.042	0.035	0.032	0.028	0.025	0.022	
MATERIAL	Aluminum		UF	UF	UF	UF	UF	UF	UF	UF	UF	UF	LF	LF	LF	LF	LF	
	Aluminum bronze		UF	UF	UF	UF	UF	LF	LF	LF	LF	LF	LF	LF	LF	MF	MF	
	Brass (admiralty)		UF	UF	UF	UF	UF	UF	UF	UF	LF	LF	LF	LF	LF	LF	LF	
	Brass (70/30)		UF	UF	UF	UF	UF	UF	UF	UF	LF	LF	LF	LF	LF	LF	LF	
	Brass (85/15)		UF	UF	UF	UF	UF	UF	UF	UF	UF	LF	LF	LF	LF	LF	LF	
	Brass (95/5)		UF	UF	UF	UF	UF	UF	UF	UF	UF	UF	LF	LF	LF	LF	LF	
	Copper		UF	UF	UF	UF	UF	UF	UF	UF	UF	UF	UF	UF	LF	LF	LF	
	Copper-nickel (70/30)		UF	LF	LF	LF	LF	LF	LF	LF	LF	LF	MF	MF	MF	MF	MF	HF
	Copper-nickel (90/10)		UF	UF	UF	UF	LF	LF	LF	LF	LF	LF	LF	MF	MF	MF	MF	MF
	Copper-nickel (95/5)		UF	UF	UF	UF	UF	LF	LF	LF	LF	LF	LF	LF	LF	MF	MF	
	INCONEL® 600		LF	LF	LF	LF	LF	MF	MF	MF	MF	MF	MF	HF	HF	HF	HF	HF
	Stainless steel 304/316		LF	LF	LF	LF	LF	LF	LF	MF	MF	MF	MF	MF	MF	HF	HF	HF
	Titanium 99%		LF	LF	LF	LF	LF	LF	LF	LF	LF	MF	MF	MF	MF	MF	HF	HF
	Zirconium		LF	LF	LF	LF	LF	LF	LF	LF	LF	MF	MF	MF	MF	MF	MF	HF

Table 3 – ECT-BBST Frequency range

CODE	FREQUENCY IN kHz		
	Min.	Max.	Central
UF	1	10	5
LF	10	100	50
MF	50	500	250
HF	100	1 000	500

The ECT calibration tube used in this document includes the following flaws:

- Internal groove, 10% of wall loss
- External groove, 20% of wall loss
- Hole, 100% of wall loss
- OD Flat Bottom Hole (FBH) at 40%, 60% and 80% depth
- OD 4 x FBH 20% depth

Other combinations of flaws can be used to calibrate the probe and to build sizing curves.

Note: Fill factor and selection tables may differ for other types of bobbin probes. Please refer to the tubing probe catalog on our website to find out more.

## PROJECT AND INSPECTION FILES

In this section, we will create a folder structure that will manage the saving location of your setup, data and report. This management is operated through the creation of a *Project*.

Magnifi suggests two levels of files. The first level is the *Project*. It is meant to include different inspections that are related in some way. For instance, it can include all the inspections done at a refinery shutdown and be named *Refinery\_Shutdown\_May\_2018*. The second level of file is the *Inspection* folder. Inspection folders are saved in the project file. An inspection folder can include the data specific to the inspection of a tube bundle with a specific technology and could be named *SS316\_075x0.065\_ECT*, for instance. This inspection folder groups the setup, the tube list, the data files and the Magnifi report.

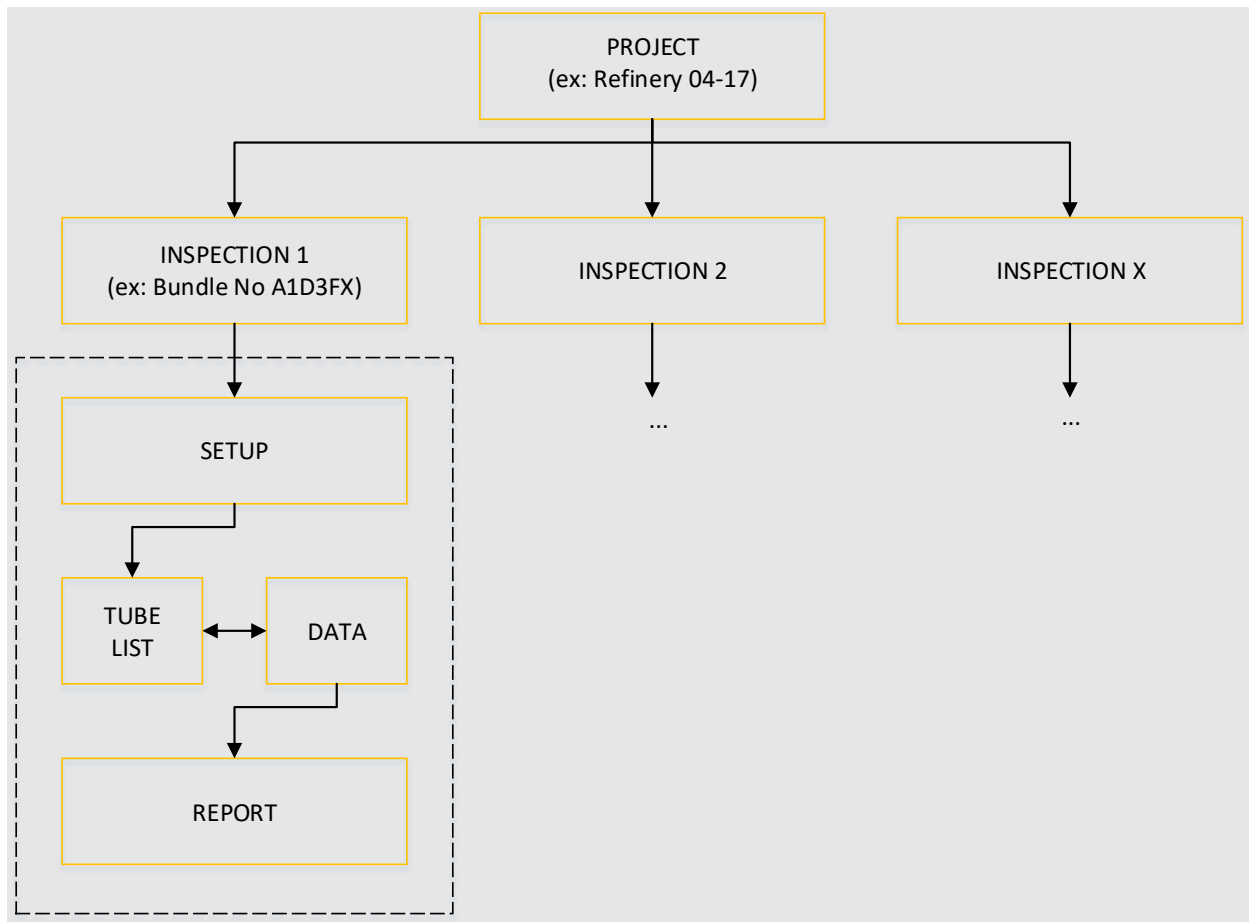

When you open Magnifi, the first page displayed is called the *Backstage*.

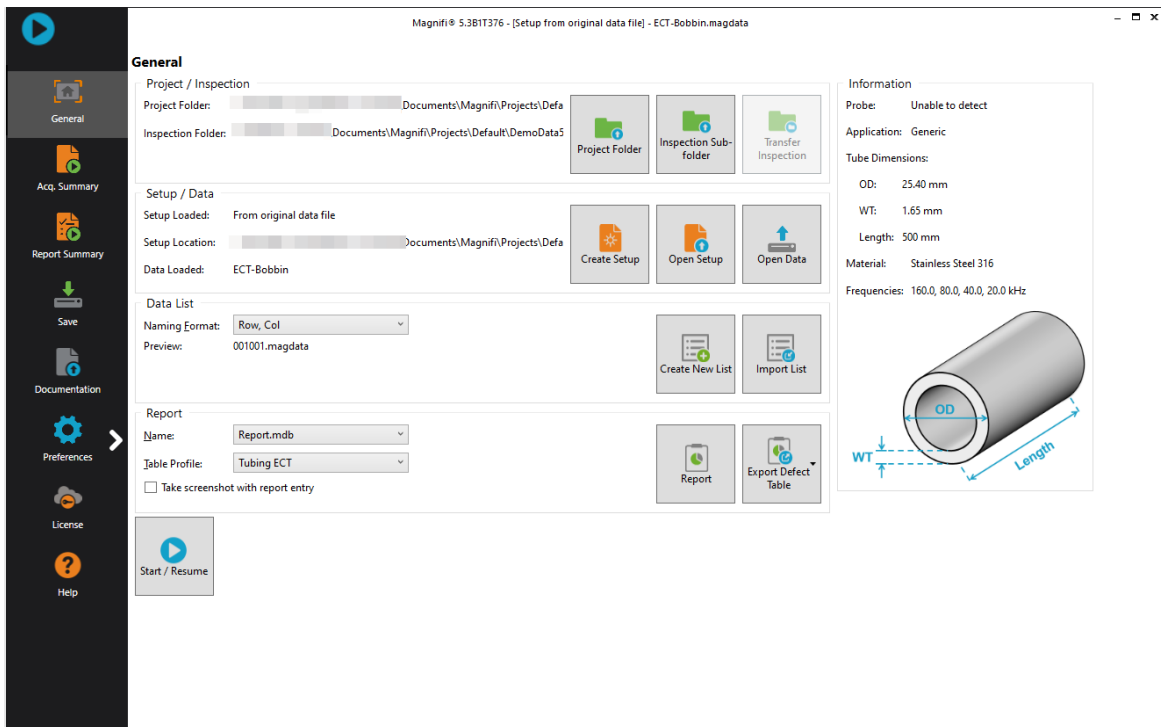

To create or open a project, click on *Open/Add Project* in the backstage. You can select an existing project/folder or you can create a new folder.

1. Create a folder by right-clicking on the location where you want to add your project file. Select *New, Folder* and enter the chosen name. You can then select the newly created folder and click on *Select Folder*.

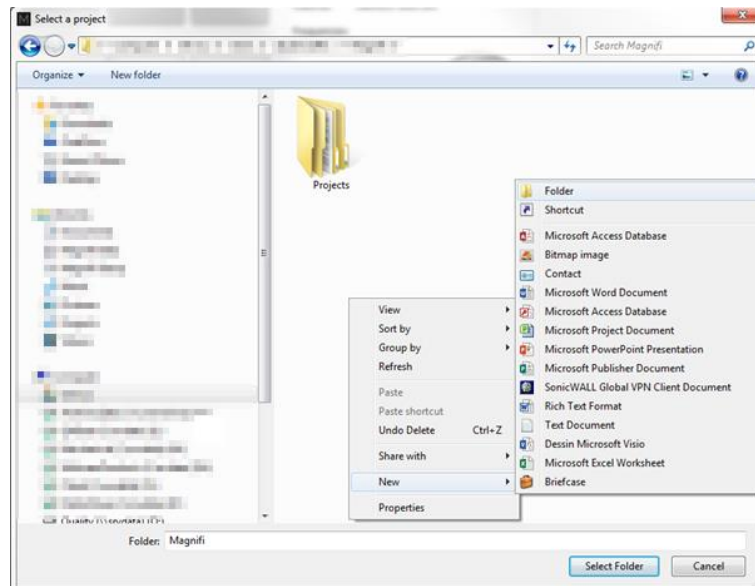

2. Click on *Inspection Sub-folder* in the backstage, then click on *Add* and enter the name of your inspection.

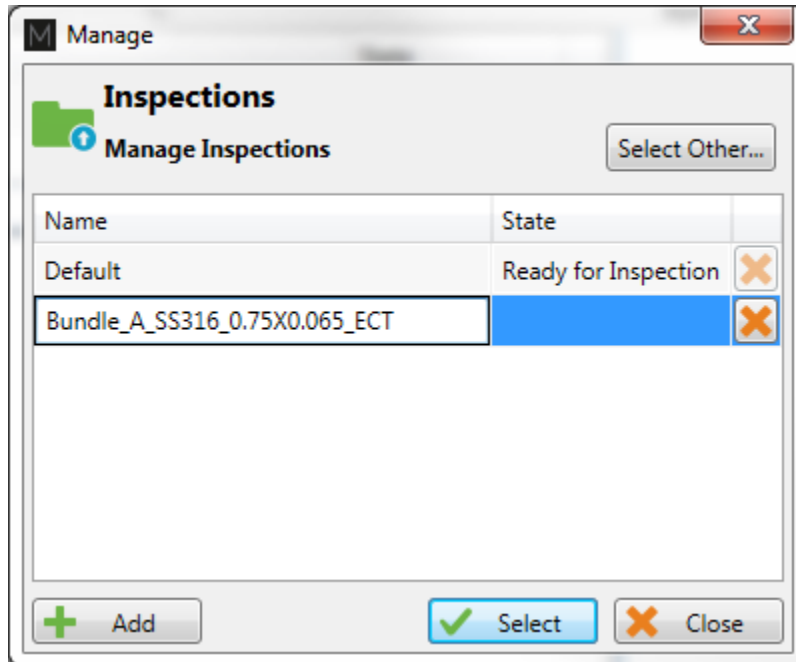

3. Click *Select*. This will define the position where the setup(s) and data will be saved.



## SETUP WIZARD

---

In this section, we will show how to create a setup using the *Setup Wizard* in Magnifi.

Before going further, you can change the measurement unit. To do so, click on *Preferences*. In the *System* tab, you can change the measurement units from metric to imperial and vice versa. For the metric units, you can choose to use meters, centimeters, or millimeters in the *General* tab. The default measurement for imperial units is inches. When finished, click on *Preferences* again to go back to the *General* window.

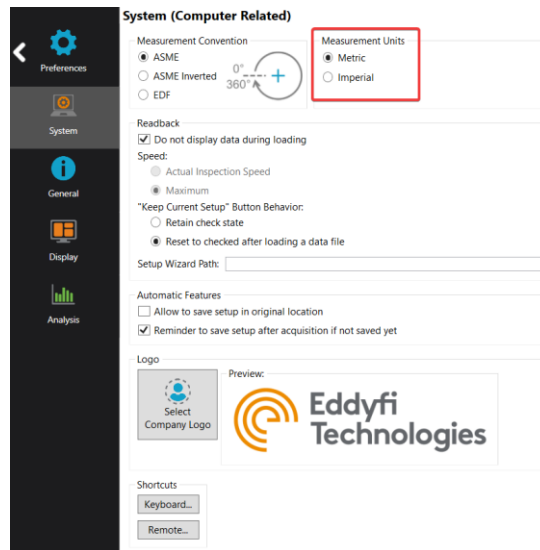

To create a new setup, it's strongly suggested to use the *Setup Wizard* process. Click on *Create Setup* to start the *Setup Wizard*.

## COMPONENT DEFINITION

The first page shown by the *Setup Wizard* is the *Component Definition*.

Click on the *Material* field to open the drop-down menu. Select the material of the tube to be inspected. If the material is not in the list, you can click on *Manage...* to open the *List of Available Material* window.

**New Setup Wizard** ×

**Component Definition** ■

Configure the geometry and material of the component to inspect

**Geometry:**  Surface  Tube from ID

**Application:**  Generic  Air Conditioner

**Material:** Carbon steel Manage...

Resistivity: 21  $\mu\Omega\cdot\text{cm}$   
Permeability: 450  $\mu$   
Velocity: 5890.000 m/s

**Wall thickness:** 1.65 mm

16 BWG  
6 24

**Outside diameter:** 19.05 mm

**Length:** 6000 mm

Note about selected material:  
ASTM: A178, A179, A192, A210, A214

✗ Cancel ◀ Back ▶ Next

To add a new material to the list, click on *Add*. A new line will appear in the list. Give the material a relevant name and set the material resistivity and permeability to its theoretical value. The ultrasound velocity is used to set IRIS parameters only, and doesn't need to be set if an IRIS inspection is not performed on this material.

It's possible to add a note about the material to specify information such as its application or composition. When you are done, click *OK*.

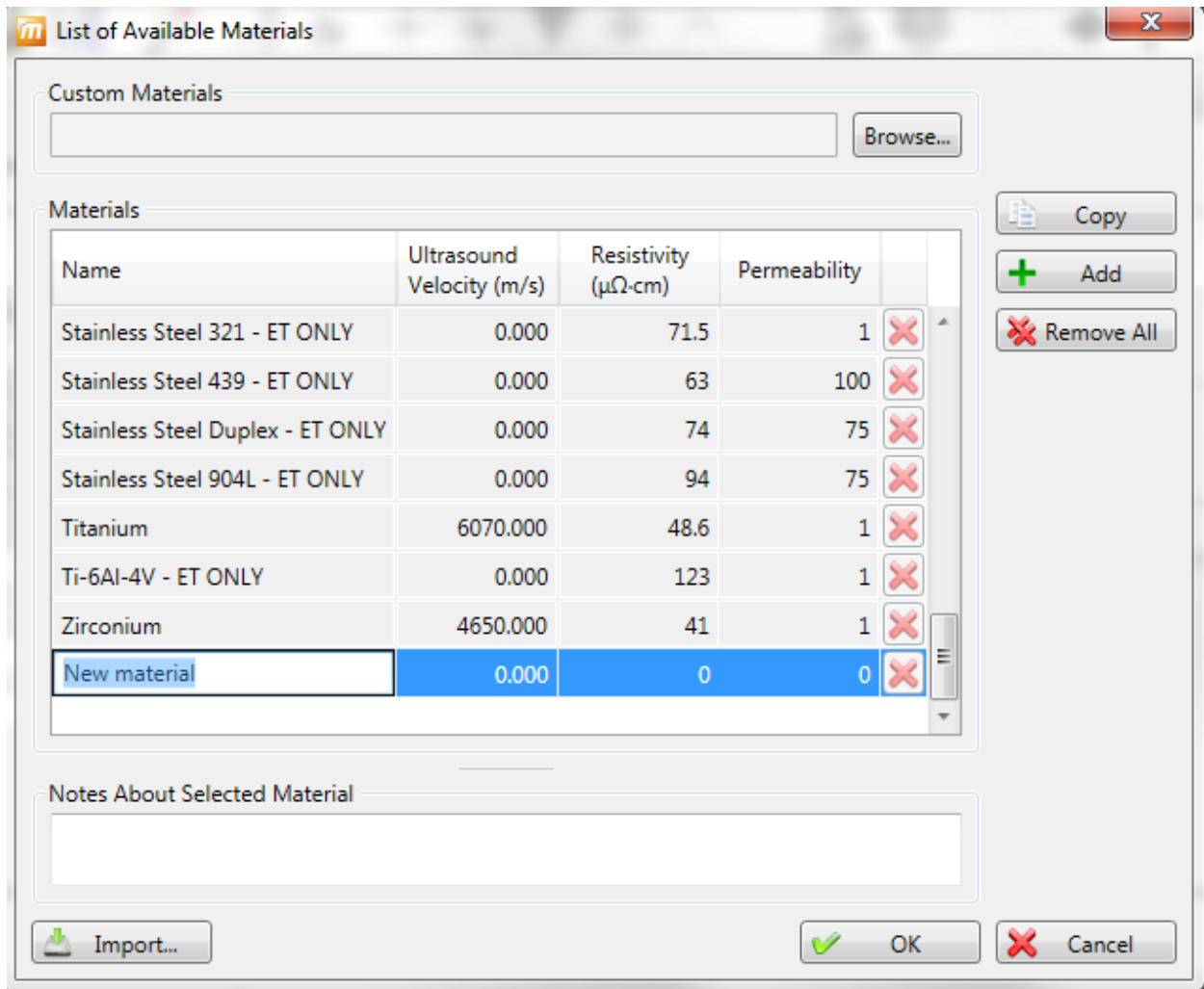

You will be back to the *Component Definition* window. If you added a new material, it will now be available in the material list.

Adjust the tube wall thickness by entering the value in the *Wall thickness* field or by moving the slider. Enter the tube's outer diameter and length.

These tube properties will help Magnifi to suggest the optimal scan parameters.

Click *Next* when everything is set correctly.

## PROBE SELECTION

In the *Probe Selection* window, select the probe you will be using for your inspection.

You can filter the probe list by choosing an inspection technique from the *Technique* drop-down menu. More precise filtering can be done by using the *Model* drop-down menu. You can then select your probe by its catalog number (PRBT-ECT-BBST) and then click *Next*.

The screenshot shows a software window titled "New Setup Wizard" with a sub-header "Probe Selection". Below the header is a progress bar and the instruction "Select the probe that you want to use for your inspection". There are two dropdown menus: "Technique:" set to "ECT" and "Model:" set to "Bobbin". Below these is a table of probes. The table has four columns: "Tech", "Model", "Catalog Number", and "Description". One row is highlighted in blue, showing "ECT", "Bobbin", "PRBT-ECT-BBST", and "ECT standard bobbin probe, ABS/DIF". At the bottom right, there are buttons for "New...", "Manage...", "Cancel", "Back", and "Next".

Tech	Model	Catalog Number	Description
ECT	Bobbin	PRBT-ECT-BBST	ECT standard bobbin probe, ABS/DIF

## SCAN DEFINITION

The *Scan Definition* window is used to configure the axial position measurement method, the acquisition rate and the typical probe speed.

New Setup Wizard

### Scan Definition

Configure the type of scan you will be performing with your probe

Scan: Single Pass

Position from: Clock

Acquisition rate: 2000 Hz

Typical probe speed: 1000.0 mm/s

Acquisition Size: 600.000 s  Maximum

Cancel Back Next

The position along the tube can be defined by using either the internal clock of the system, or by using an axial encoder. If you use the internal clock, the default position will be given assuming that the probe is always pulled at the typical probe speed. If the typical probe speed is set to 300mm/s, and the time since the acquisition began was 2 seconds, then the system will indicate a position of 600mm. Using an encoder will give you the exact position of the probe. Note that the position can also be obtained by using the landmark tool, but this feature will be shown later.

The acquisition rate is the number of acquisition points taken per second. By default, the acquisition rate is set to 2000 Hz for ECT, but depending on the drive frequency used to inspect, the actual acquisition rate

may differ. The system will automatically readjust this value if needed. For standard eddy current probes, the acquisition rate can always be set at 2000 Hz.

The axial resolution will depend on the combination of the acquisition rate and pulling speed. For an acquisition rate of 2000 Hz, the pulling speed needs to be less than 1m/s to have at least 2 points per millimeter. If you do not use a pusher-puller device such as the Probot, the pulling speed won't be constant. Therefore, it is recommended to target a lower pulling speed to be able to reach your axial resolution target. The typical probe speed should be set as close as possible to the real value - this will help the algorithm that automatically detects landmarks (this will be explained in the Landmarks section). The recommended pulling speed for ECT is approximately 300mm/s.

If you select to measure the position from Encoder, different fields will appear, and a second *Scan Definition* page will become available.

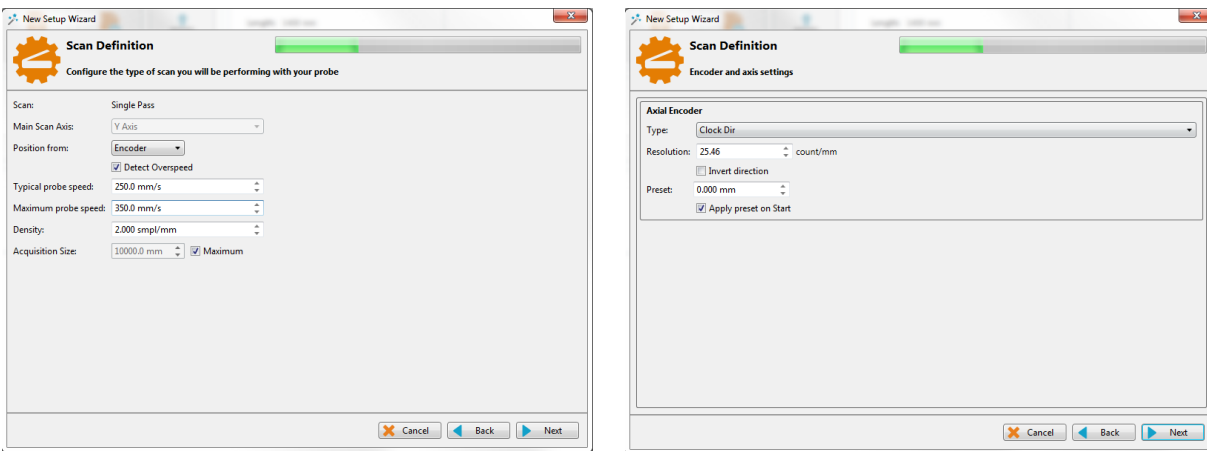

On the first page, the *Typical probe speed*, *Maximum probe speed* and the *Density* will have to be entered. The *Maximum probe speed* is the maximum acceptable speed for your probe and the *Density* is the number of acquired points per millimeter (axial resolution). These values will be used to set the acquisition rate and to optimize the acquisition processes used by the Ectane. Note that if your probe is pulled at a speed exceeding the *Maximum probe speed*, there will be gaps in the data.

The second page includes the type of encoder and its resolution. A preset can also be specified if your acquisition doesn't start at 0 mm.

Click *Next* when you're finished.

## DATA DEFINITION

The *Data Definition* window is used to set the hardware gain, frequency and drive voltage for the *Absolute* and *Differential* channels. It is important to set these parameters correctly before acquiring the data since they are driven by the instrument and cannot be modified during the analysis.

Gain: 58 dB

Channels	
Name	Prefix
<input checked="" type="checkbox"/> Absolute	ABS
<input checked="" type="checkbox"/> Differential	DIF

Required frequencies			
Prefix	Val (kHz)	Ampl (V)	Phase (°)
F1	57.6	2.50	0.0
F2	28.8	2.50	0.0
F3	14.4	2.50	0.0
F4	5.0	2.50	0.0

At least one suggested frequency is out of bounds and has been clamped.

Suggest + Add

Cancel Back Next

By default, Magnifi suggests four frequencies theoretically calculated with the parameters previously entered:

Prefix	Frequency
--------	-----------

F1	2 x F90
F2	F90
F3	F90/2
F4	F90/8

The frequency and drive voltage can be changed by replacing their values in the *Required frequencies* table. Up to 4 frequencies can be set at the same time, and the sum of their amplitudes cannot exceed 10V.

Make sure that the frequencies are within the probe limits that you can find in Table 3. If one of the suggested frequencies is not within the recommended probe frequency range, you can either remove it by clicking on the X or change it within the recommended range.

Click on *Next* when the desired parameters are entered.

The next window is used to build mixed channels. Mixes are processed channels that are mainly used to detect indications close to support plates. They are built with 2 frequencies of the same channel type to attenuate the effect of the support plate and to be able to size an indication at this location more accurately.



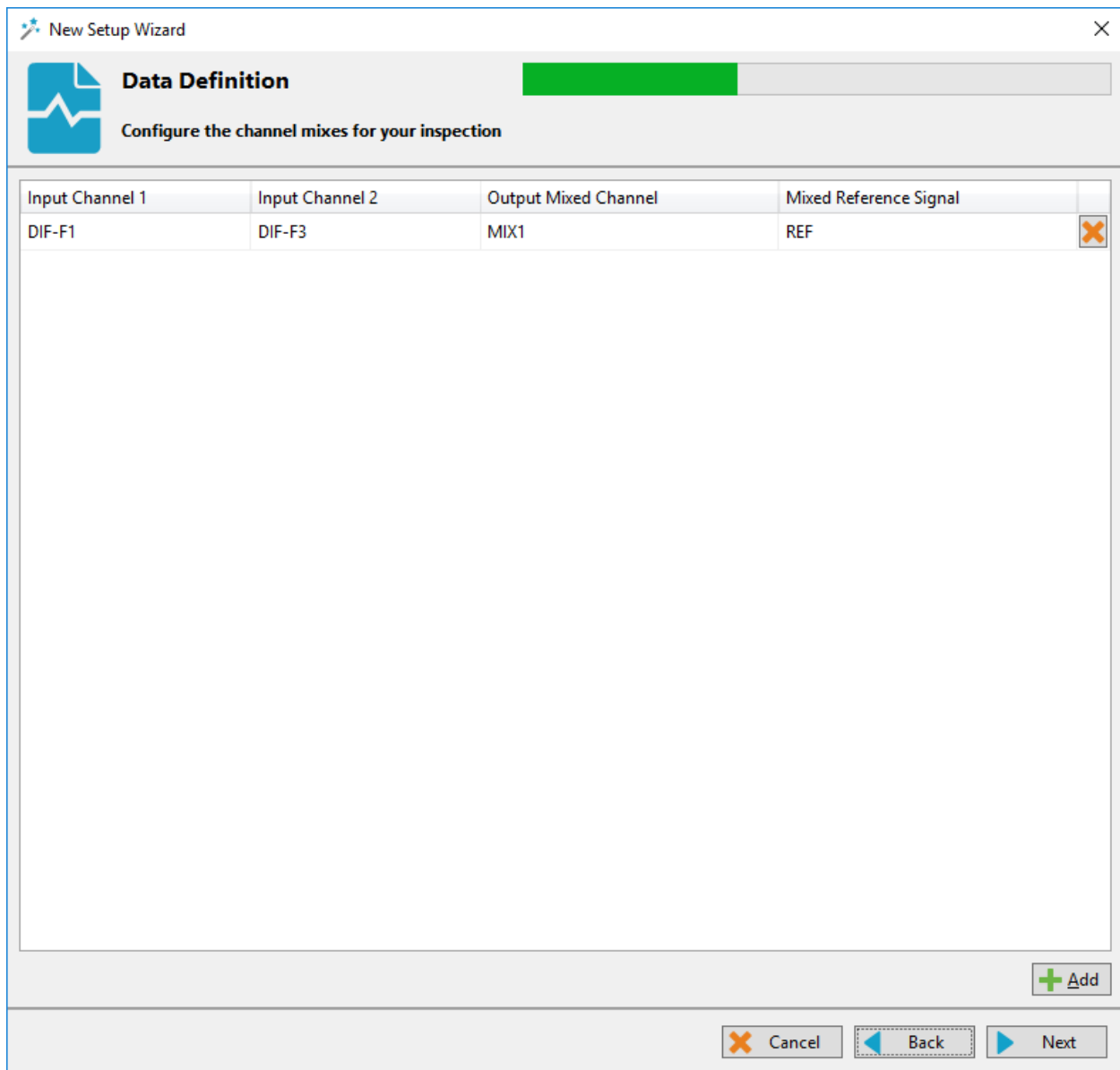

If you do not wish to use mixed channels, click on *Next*.

To add a mixed channel, click on the *Add* button. A new line will appear. Choose from which input you want to use the mixed channel. Note that *Input Channel 2* must have a lower frequency than *Input Channel 1*. Mixed channels can be built for both absolute and differential channels.

You can rename the mixed channel output by modifying the *Output Mixed Channel* field.

The *Mixed Reference Signal* (usually a support plate signal) will be used to calibrate the mix channel. The system will apply processes to the chosen input channels and will subtract them to eliminate the reference signal.

Click on *Next*.

## DATA PROCESSING

The *Data Processing* window is used to configure the signal processing to apply to the channels.

You can choose to configure every frequency individually or you can apply the same filters to every channel with the *Individually configure all the channels* check box.

Note that the signal processing is done after the data acquisition. An inappropriate parameter choice can be changed without any problem during data analysis, while wrong parameter choice for the data acquisition can mislead the analysis. It is possible to change the filter parameters after data acquisition, so it is always possible to fine tune the filter parameters during analysis.

Individually configure all the channels

Name	Low Pass		Median High Pass	
		Cutoff (Hz)		Window Size (smp)
ABS-	<input checked="" type="checkbox"/>	400	<input type="checkbox"/>	301
DIF-	<input checked="" type="checkbox"/>	400	<input type="checkbox"/>	301
MIX1	<input checked="" type="checkbox"/>	400	<input type="checkbox"/>	301

Cancel Back Next

The low pass filter eliminates part of the signal that is above a certain frequency. As an example, it is useful when your defect signal has a lower frequency content than the background noise. In this case, using a

filter will remove part of the noise without removing the defect's signal. This may help with data analysis. However, a cutoff frequency that is too high won't remove much noise, and a cutoff frequency that is too low will filter out the defect's signal.

The median high pass filter is used to filter out low frequency noise or drift such as lift-off variations of the probe within the tube, changes in material, geometry or thickness. As a rule-of-thumb, the width of the high-pass median filter should be set to at least three times the axial length of the longest flaw that may be encountered. Data should be examined in both its filtered and unfiltered states. It is important to keep in mind that the median high-pass filters can distort phase. More information about median filters for NDT analysis can be found on Eddyfi's blog.

Click *Next* when you are done.

## CALIBRATION POINTS

The *Calibration Points* page is used to define the points in your calibration tube. These indications will later be used to calibrate your probe and to build sizing curves.

The units of measurement can be set in percentage or in depth (millimeters or inches).

You can add calibration points by clicking on the *Add* button. Specify the calibration point name, side and size. The side and size of the flaw will be used to position the calibration point on the sizing curve(s).

Calibration points can also be imported with the *Import* button.

New Setup Wizard

### Calibration Points

Configure calibration points used for channels and sizing curves

Units of measurement: Percentages (%)

Name	Side	Size	
HOLE	Through	100.0	X
FBH-80	OD	80.0	X
FBH-60	OD	60.0	X
FBH-40	OD	40.0	X
4 x FBH-20	OD	20.0	X
IDGR-10	ID	10.0	X
ODGR-20	OD	20.0	X
ODGR-40	OD	40.0	X
ODGR-60	OD	60.0	X
SUPPORT	Unknown	0.0	X
LIFT-OFF	Unknown	0.0	X
REF	None	0.0	X

Import Add

Cancel Back Next

Click *Next* when you have set the required calibration points for your calibration(s) and sizing curve(s).

## CALIBRATION

The *Calibration* page is used to define reference signal(s) that will be used to set the amplitude(s) and phase(s) of each channel using the selected measurement method.

By default, the calibration is performed on the Hole signal by adjusting it to 1V and 40° on both the absolute and the differential channels. However, the calibration can be done differently on each channel type. It can also be done individually for each frequency by selecting the *Individually configure all the channels* option. Different reference signals can be set to calibrate the phase and the amplitude independently.

Individually configure all the channels

Name	Amplitude			Phase		
	Voltage (V)	Reference	Measurement	Angle (°)	Reference	Measurement
ABS-	1.00	HOLE	MP	40.0	HOLE	MP
DIF-	1.00	HOLE	PP	40.0	HOLE	PP
MIX1	1.00	HOLE	PP	40.0	HOLE	PP

Buttons: Cancel Back Next

When you select the reference signal, the system will use the selected measurement method to apply a rotation and a gain. Here is a short description of the available options:

**14. Absolute (A):**

Uses a straight line from the Lissajous origin to the main cursor position to measure amplitude.

**15. Absolute Horizontal (AH):**

Uses only the horizontal component, from the Lissajous origin to the main cursor position to measure amplitude.

**16. Absolute Vertical (AV):**

Uses only the vertical component, from the Lissajous origin to the main cursor position to measure amplitude.

**17. Absolute Peak (AP):**

Uses a straight line, from the Lissajous origin to the peak value of the data selection, to measure amplitude.

**18. Absolute Peak Horizontal (APH):**

Uses only the horizontal component, from the Lissajous origin to the peak value of the data selection, to measure amplitude.

**19. Absolute Peak Vertical (APV):**

Uses only the vertical component, from the Lissajous origin to the peak value of the data selection, to measure amplitude.

**20. Average Peak (MP):**

Takes the distances from points at the extremity of the cursor to the peak of the data selection to build an average vector. Only used and recommended for absolute signals.

**21. Average Peak Horizontal (MPH):**

Uses the horizontal component of the distances from points at the extremity of the cursor to the peak of the data selection to make an average vector. Used for absolute signals.

**22. Average Peak Vertical (MPV):**

Uses the vertical component of the distances from points at the extremity of the cursor to the peak of the data selection to make an average vector. Used for absolute signals.

**23. Peak to peak (PP):**

Uses the combination of the vertical and horizontal component to measure the maximum amplitude.

**24. Horizontal (PPH):**

Uses only the horizontal component to measure the amplitude.

**25. Vertical (PPV):**

Uses only the vertical component to measure the amplitude.

**26. Peak to peak First Transition (PPF):**

Uses the combination of the vertical and horizontal components of the first transition of the signal to measure maximum amplitude. The first signal transition is from the base of an indication to its peak.

Click on *Next* when the parameters in the table are set according to your requirements.

## SIZING CURVES

The first page of this section is the definition of your sizing curves. A curve will be built for each line in this table.

ID	Name	Source	Measurement	
	ABS-F1	ABS-F1	Phase	X
	ABS-F2	ABS-F2	Phase	X
	DIF-F1	DIF-F1	Phase	X
	DIF-F2	DIF-F2	Phase	X
	MIX1	MIX1	Phase	X

The sizing curve will allow you to estimate the size of a defect based on the calibration point signals (amplitude or phase) obtained with your calibration standard. Magnifi will give you the interpolated flaw size based on the built sizing curves.

Sizing curve names are customizable. The channel source and measurement type can also be changed. You can add sizing curves by clicking on the *Add* button.

Click *Next* when you are done.

For every sizing curve created in the last window, a window will appear to configure the curve properties. The name of the curve will be shown in the upper left corner of the page (ABS-F1 in the example below).

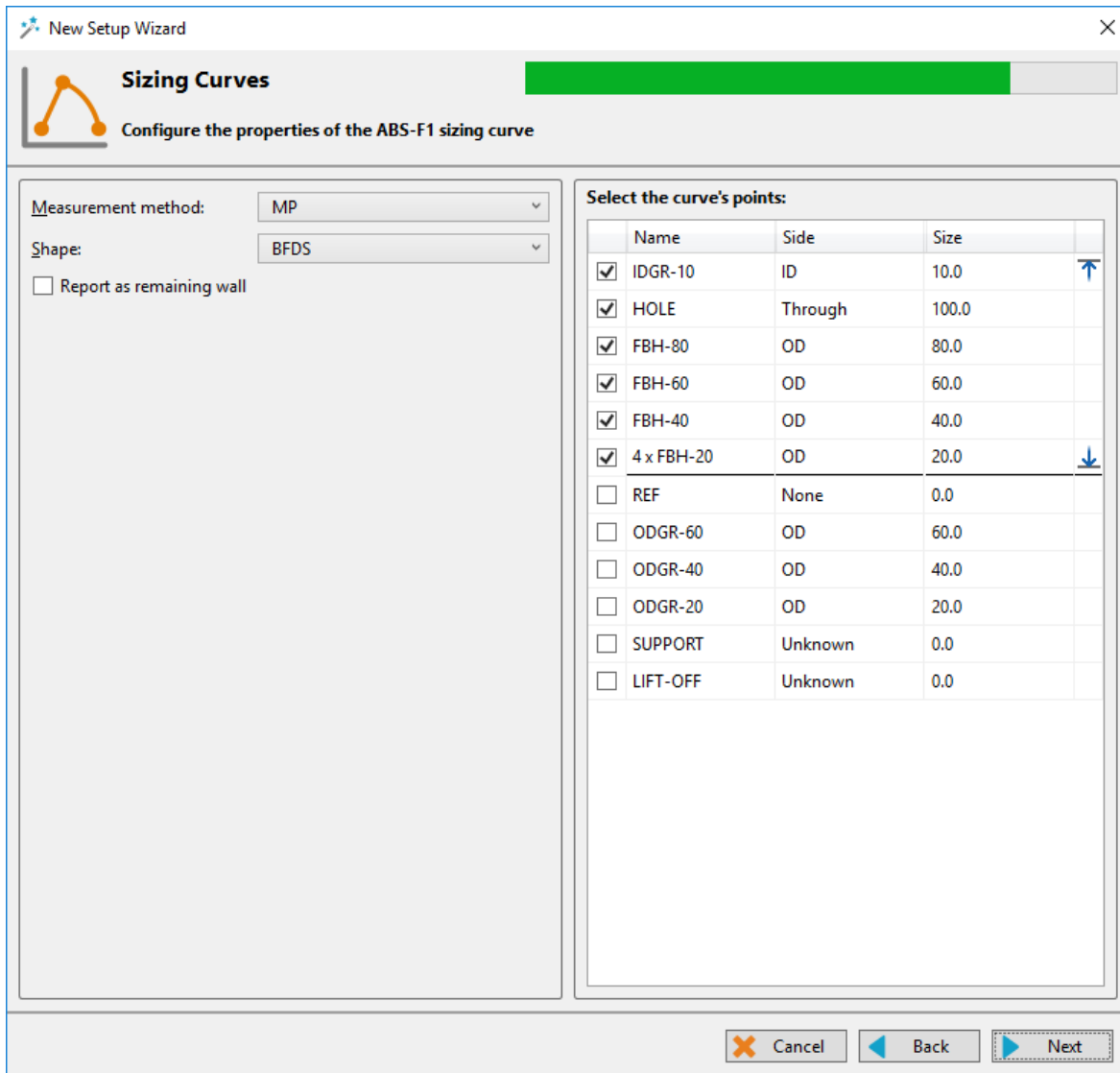

The measurement method options are the same as what is described in the calibration section of this document. By default, the average peak option is set for absolute channels, and the peak-to-peak option is used for the differential channels.

The interpolation method can be selected with the *Shape* dropdown menu. Here is a short description of the available options:

1. **Best Fit (Dual linear) (for phase measurement only):**  
A curve with two linear segments representing ID and OD (or Near and Far) side calibration points with respect to phase.
2. **Best Fit (Dual Slope) (for phase measurement only):**



A curve with two segments representing ID and OD (or Near and Far) sides. The ID section is linear, and the OD section is polynomial. The OD side of the curve will need at least three points (including the hole) in order to trace a polynomial curve.

**3. Best Fit (Polynomial) (for phase and amplitude measurements):**

Best polynomial (degree 2) interpolation within the measured calibration points (requiring at least three points).

**4. Connected Points (for phase and amplitude measurements):**

Simple, point-to-point curve.

**5. Best Fit (Linear) (for phase and amplitude measurements):**

Best linear interpolation within the measured calibration points

**6. Best Fit (Dual Polynomial) (for phase and amplitude measurements):**

Polynomial (degree 2) interpolation with two segments for both ID and OD sides of the curve. Need at least three points.

The linear options are mostly used when few data points are available, while the Best fit (Dual Polynomial) option is a more precise method when your calibration tube has multiple defects.

Once the measurement method and the interpolation curve shape are chosen, you can select the curve points for each sizing curve previously created. The order in which the points appear in the list may influence your sizing curve. Make sure that the measured values of the calibration points are in ascending order on the list. You can set Magnifi to show the remaining wall instead of the defect size by checking the box *Report as remaining wall thickness*.

Click *Next* when you are done.

## INDICATION CODES

The *Indication Codes* page is used to define the entries that can be added to the report when analyzing the data.

Code	Description	Type	Automatic	Color	
COR	Corrosion	Defect			X
CRK	Crack	Defect			X
DNT	Dent	Defect			X
DSI	Distorted support indicatic	Defect			X
ERO	Erosion	Defect			X
NDD	No defect detected	No indication			X
OBS	Obstructed	Feature		Red	X
PIT	Pitting	Defect			X
PLG	Plugged	Feature		Brown	X
RST	Restricted	Feature		Yellow	X
WLL	Wall loss long	Defect			X
WLS	Wall loss short	Defect			X
WLT	Wall loss taper	Defect			X

When an indication is added, its abbreviation (code) is shown in the code pane, next to the data.

You can modify the default indications codes list by changing the parameter in the table. New indications can be defined by clicking on the *Add* button.

Click *Next* when you are done

## DISPLAY

The first *Display* window is used to set how the data is displayed during and after the acquisition.

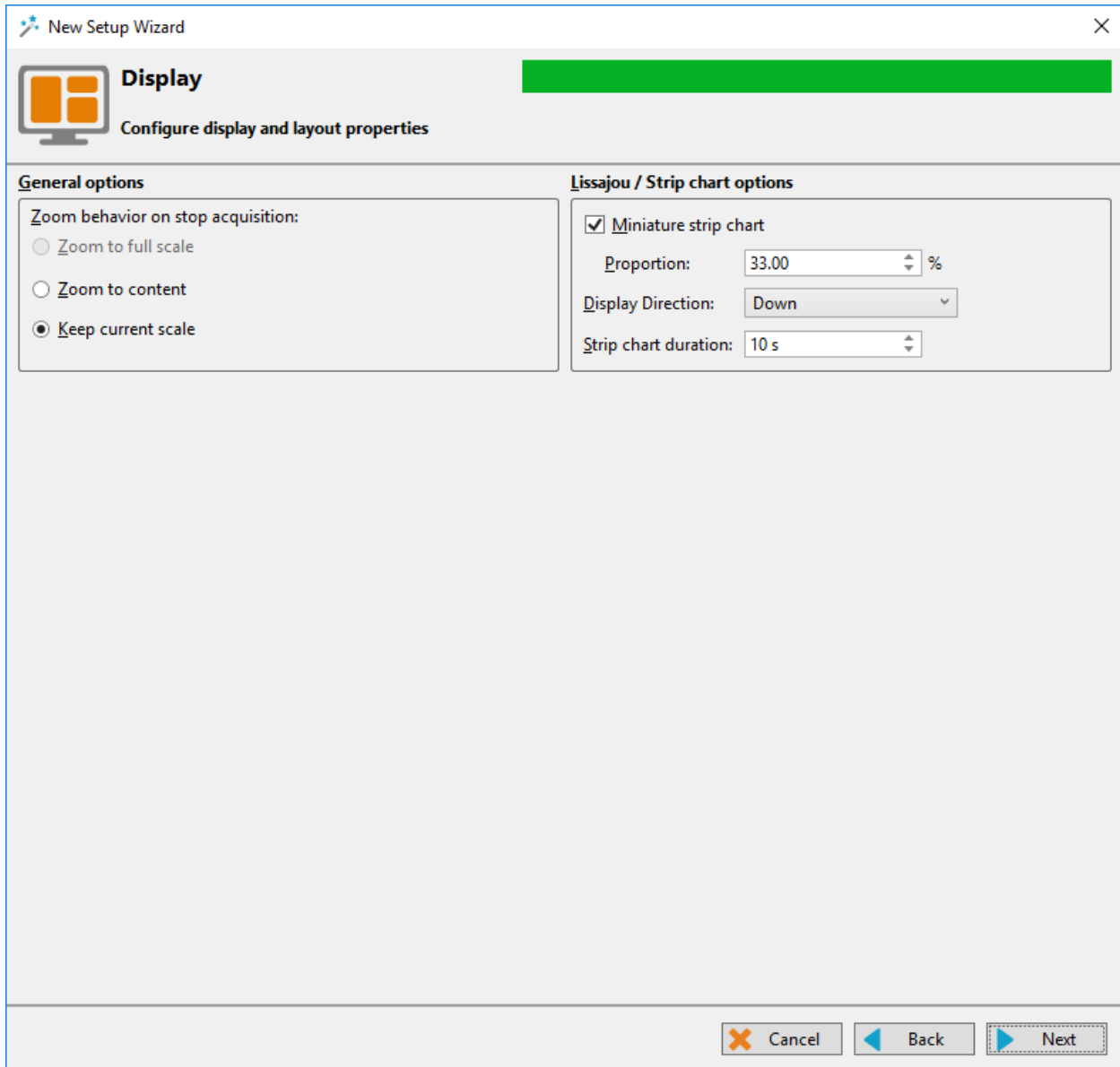

The scroll direction is the direction in which data appears on the screen. If you choose downward, the signals will go from the top to the bottom of the screen. If you choose the upward direction, the signal will go from the bottom to the top of the screen.

You can enable/disable the miniature strip chart under the Lissajous by checking/unchecking the box.

The strip chart duration is the length of a Strip chart window when the data is acquired.

Click *Next*.

The second *Display* window is used to set the layouts. Checking the tick boxes in this window will make the proposed layouts available in your setup. You will be able to switch from one to the another via the layout tab. The " S " stands for Strip chart, " L " for Lissajous and " C " is for the defect Code indication zone.

The layout with the blue background will be the one opened by default, which can be changed to your desired option.

Layouts can be readjusted at any time.

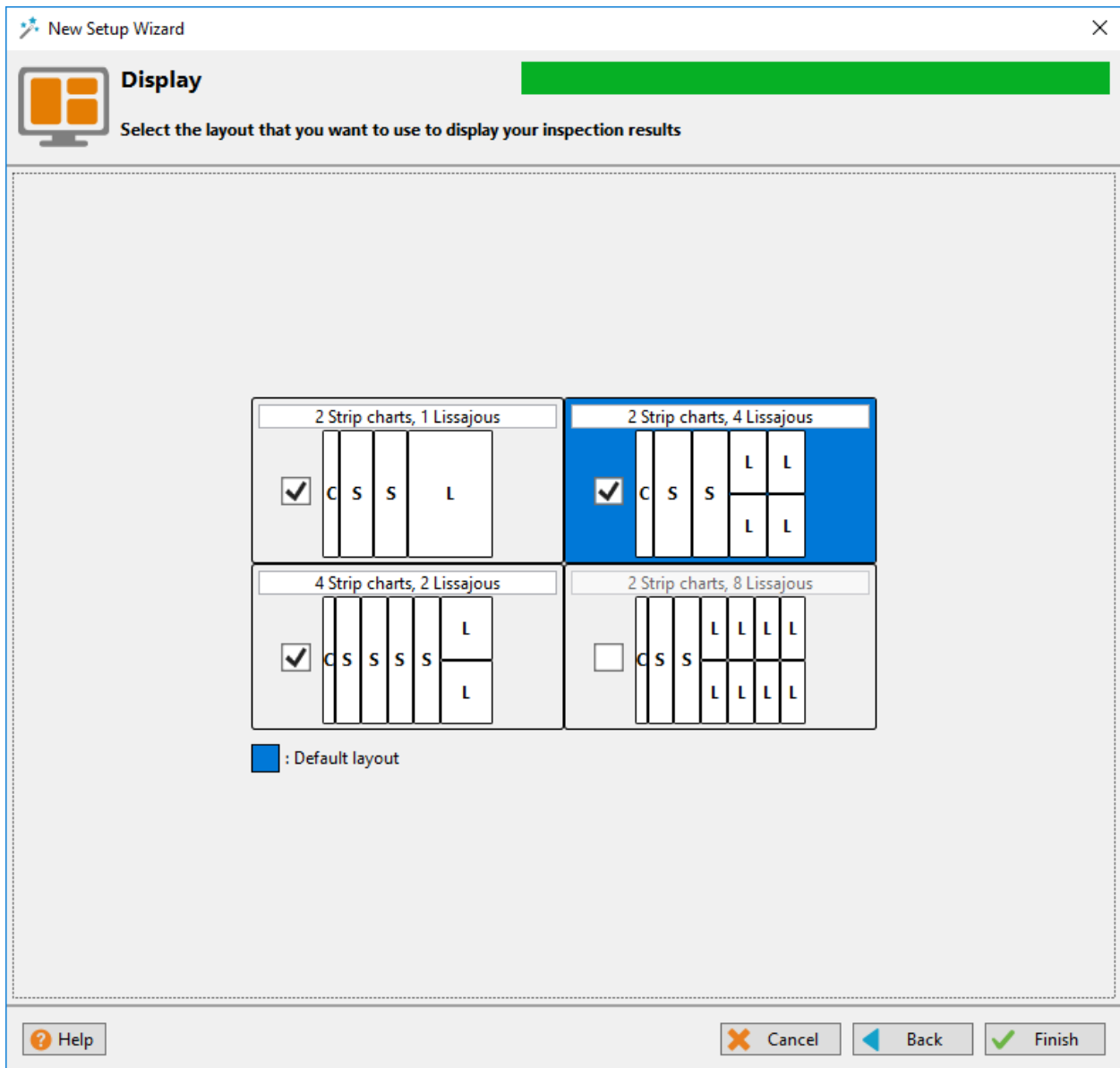

Click *Next* to complete the setup wizard process.

## SETUP MODIFICATIONS

Some parameters or preferences may need to be modified after the *Setup Wizard* process. To modify the parameter previously entered, you can go to the *Setup* tab in the *Frontstage* and click on the button associated with the parameter you want to change.

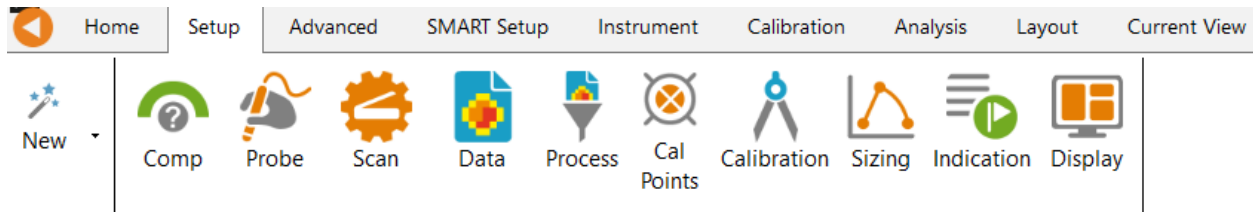

This will open one of the windows previously described, where you can change the values you originally entered. If applicable, go through the process by clicking on *Next*, and then click on the *Finish* button. This will apply the modification to the setup.

Advanced settings can be found under the *Advanced* tab of the *Frontstage*. If parameters are changed using the advanced settings, the information shown using the *Setup* tab may not match your actual setup.

## SMART SETUP TOOLS

Additional functions, which facilitate data analysis, can be set up under the SMART Setup tab.

## LOGBOOK

The first button on the left side under the SMART Setup tab allows you to enable or disable the logbook.

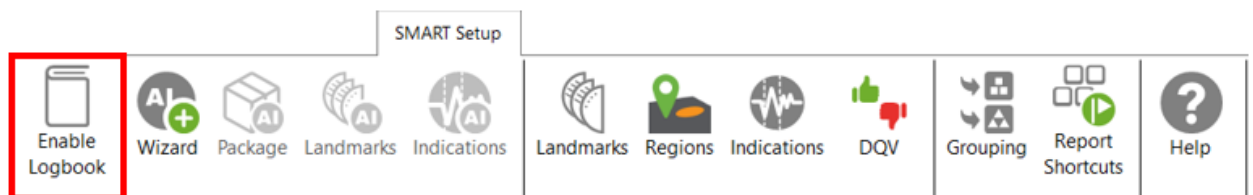





The logbook stores information about the analysis in addition to allowing the following functions: batch screening, seeing results at a glance from the data list pane and saving manual modifications made to the landmarks during the analysis.

The logbook stores the following information: landmarks (type, position, dimension, including manual modifications), indications (AI and conventional, label, position, dimension, etc.), indication grouping, and data quality validation results. When enabled, an additional column is added to the data file list to allow seeing results and to filter, sort, or analyze according to these results.

Zone	Row	Col	Icon
✓ 000	001	001	7x
✓ 002	005	005	3
✓ 002	009	007	2 2
✓ 003	004	009	2
✓ 003	005	012	2
✓ 003	006	007	8
✓ 003	007	006	1
✓ 003	007	010	1
✓ 003	009	007	
✓ 004	003	010	10 2
✓ 004	003	015	1
✓ 004	004	009	18x 2
✓ 004	004	014	27 3
✓ 004	005	008	
✓ 004	007	005	
✓ 004	007	015	1x
✓ 004	009	010	2
✓ 004	010	010	Warning

The following table shows the possible icons and their meaning:

Icon	Description	Meaning
(empty)	Empty	No logbook entry associated with this file because it has not been screened yet.
	Dashed outline circle, without a number	Logbook entry associated with the file contains information such as landmark detection or regions. The absence of additional information on the icon reveals that no indication detection engine or DQV tests were enabled when the logbook was written.
	Dashed outline circle, with a number	Logbook entries associated with the file contains information such as landmark detection as well as detected indications. The number displayed inside the circle shows the quantity of potential indications detected. No DQV tests were enabled when the logbook was written.
	Dashed outline circle, with a green check mark	The green check mark indicates that the DQV test(s) passed on this file.

	Dashed outline circle, with a red cross	The red cross indicates that at least one DQV test(s) failed on this file.
	Dashed outline circle, with a number, with a green check mark	The logbook entries associated with this file indicates that potential indications have been detected by the detection engine and that the DQV test(s) passed.
	Dashed outline circle, with a number, with a red cross	The logbook entries associated with this file suggest that potential indications have been detected by the detection engine and that at least one DQV test(s) failed.
	Orange warning triangle	The AI detection tools identified an unusual situation. In this case, the level of confidence in the detection findings could be very low. Therefore, users should pay special attention when reviewing the detection results.

The logbook is saved within the inspection folder. Its data is written when a file is screened using the dedicated buttons in the Analysis ribbon. It is also automatically written when a file is loaded while the logbook is enabled, and no logbook entry existed for this file yet.

It is worth mentioning that the logbook also includes defects and landmarks, even if these have been detected with detection tools that do not use AI (conventional landmark detection and indication boxes). Also note that the automatic indication detection tools are not available if you use the acquisition license (ACQ).

### WIZARD

AI-ECT detection of landmarks and indications can be enabled through the SMART Setup tab.

To configure this tool, click the Wizard button.



Before the Wizard is displayed, a warning message appears:

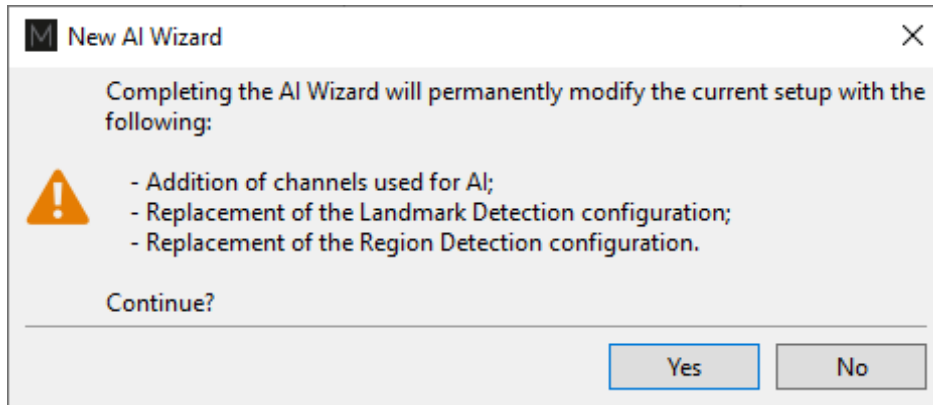

When AI is added to your setup, Magnifi applies minor changes for the detection algorithms to work:

1. Channels will be copied and renamed with the prefix "AA\_." These are additional channels that the AI engine will use for processing. The original channels in your setup will not be modified.
2. If conventional landmark detection was previously set up, it will be disabled and replaced by the AI landmark detection.
3. If conventional region detection was previously configured, it will be replaced by a set of read-only regions that are required for AI detection.

Once AI is added to a setup, it cannot be reverted. Make a copy of your installation before continuing if you want to keep a backup.

## AI PACKAGE

The first window of the wizard gives the option of choosing the appropriate algorithm for the type of equipment being inspected. In version 5.0, only one algorithm is available.

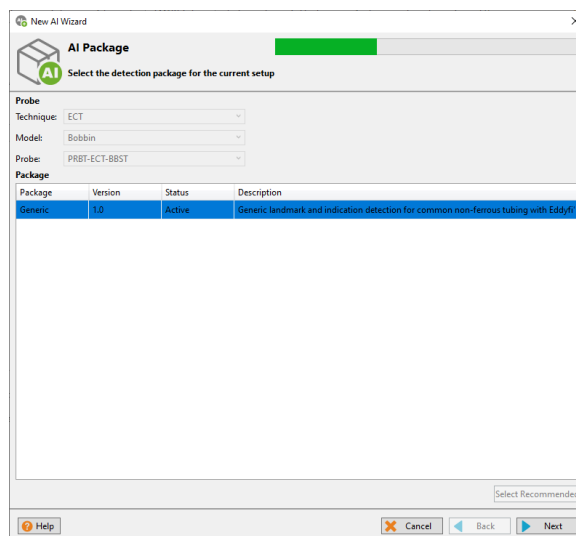

If the setup for the acquisition was done with the Setup Wizard, the probe configuration will automatically be selected. For legacy setups, the Technique, Model and Probe must be selected from the drop-down menus.



## AI LANDMARKS

The second window allows you to set the landmark detection parameters. Landmarks are important to detect defects. They allow the system to automatically create regions (e.g., tube sheet, support plates, in tube) in the tube. This allows the detection of defects in these pre-defined regions.

Type	Name
AIRI	AIRI
TSI	TSI
SP	SP
TSO	TSO
AIRO	AIRO

The fields in the upper right corner of the window allows one to enter the morphology of the exchanger and the way it is inspected. This information will be expected by the AI during its analysis.

The type of bundle inspected must be selected. The AI supports three configurations:

Straight: The tubes are straight and tube sheet signals can be acquired.

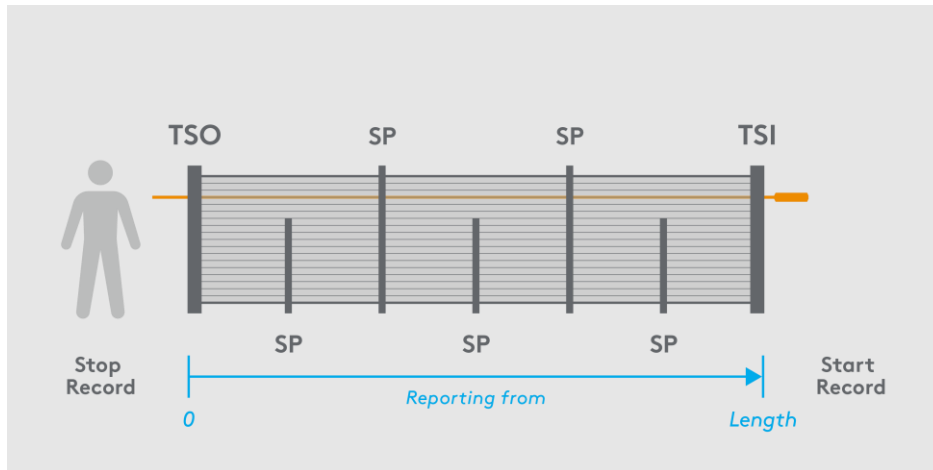

Straight restricted: A restriction is present which prevents the sensors of the probe from coming out of the tube completely. Select this inspection type if the exit is restricted on some of the tubes or all of them.

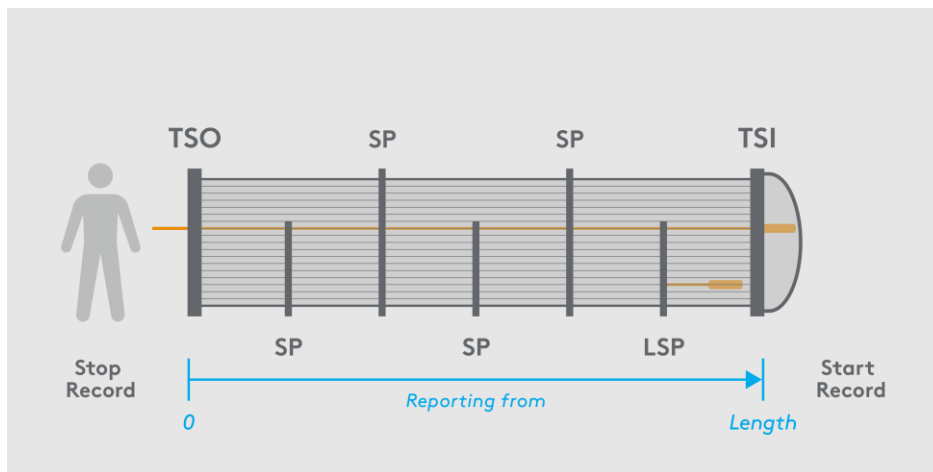

U-bend: Inspection of the straight parts only, so the scan includes only one tube sheet signal.

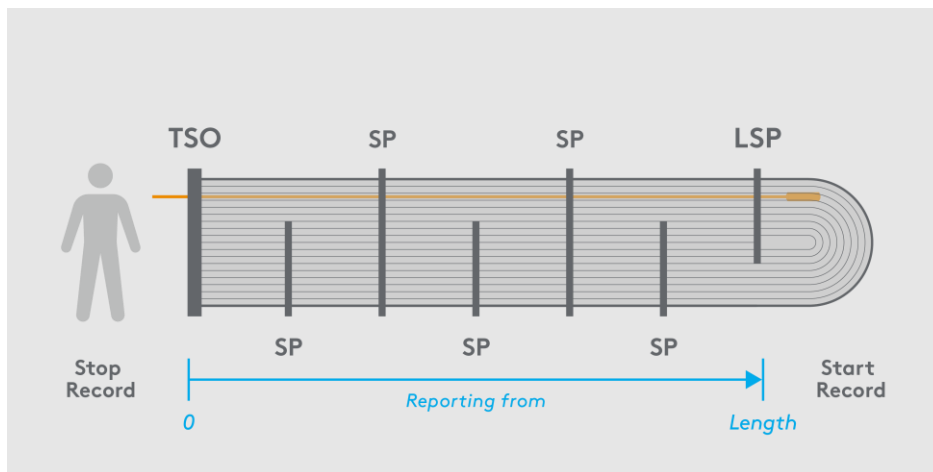

Tube length value is optional and does not affect the AI detection performance. This information is relevant if an estimate of the axial location of indications is expected. Entering the appropriate length will

result in more accurate values and a better-quality report, especially if you are using TubePro™ 5.X with 3D models to visualize the defect location.

Names for the types of detected landmarks can be customized if required. Here are the abbreviation descriptions for each type:

### AI INDICATIONS

The last window allows one to enable AI indication detection and customize the label of these detected indications. The label will be displayed in the Code view as well as in the Indications pane of the Front Stage interface.

Type	Description
AIRI	AIR In: Only used for detection in calibration tube data. Signal acquired by the probe when it leaves the air and enters the tube.
TSI	Tube Sheet In: Signal acquired by the probe when it leaves the air and enters the bundle.
LSP	Last Support Plate: Only used with Straight Restricted and U-Bend One Leg inspection types. LSP replaces TSI when a restriction prevents the probe from acquiring the full TSI signal.
SP	Support Plate signal.
TSO	Tube Sheet Out: Signal acquired by the probe when it leaves the bundle and is then in the air.
AIRO	AIR Out: Only used for detection in calibration tube data. Signal acquired by the probe when it leaves the tube and is then in the air.

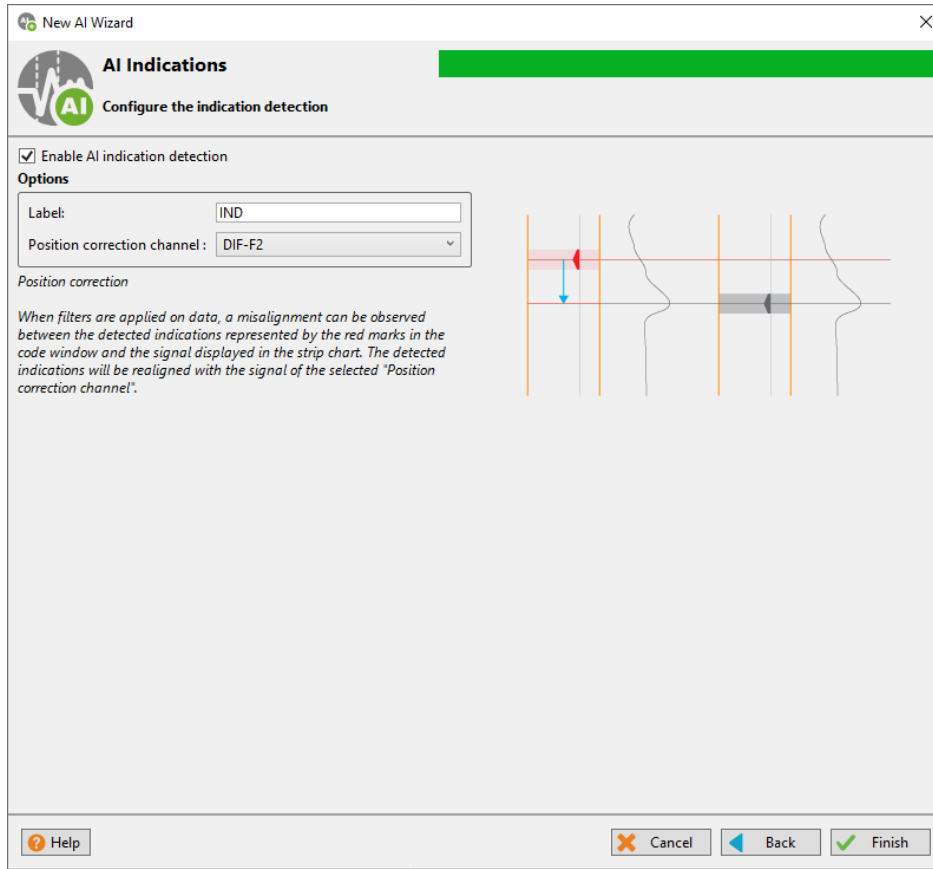

Data processing such as filtering can induce a spatial or temporal delay in the data, meaning that the whole signal in the strip charts can be slightly shifted up or down. Since the AI channels and user's channels don't necessarily have the same data processing, there can be some misalignment between them. This could translate into detected indications, represented as red marks in the Code view, appearing slightly offset compared to the indication signals observed in the strip charts of the user's channels. This is where the Position correction channel option is applicable. This parameter realigns the indications shown by the AI with the user's channel signals by applying a position correction to the AI channels.

The applied correction is calculated automatically when calibrating on the through-wall hole. This compensation is applied on every tube. If the filters are modified during the analysis, it is recommended to calibrate again to readjust the compensation.

Typically, the most used channel for reporting indications should be selected as the reference for the position correction.

## LANDMARKS

The Landmarks button is used to setup the parameters for landmark detection with conventional tools (not AI). This function is not accessible if you are using the AI landmark detection tool that is set with the AI wizard.

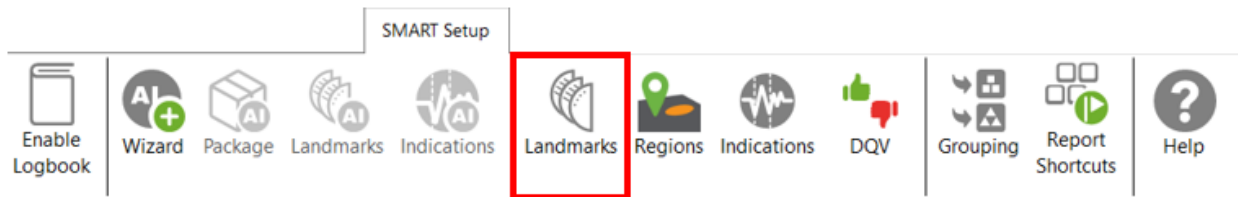

The Landmark Detection window is used to configure the automatic detection of features such as tube sheets and support plates. Landmarks are not mandatory and don't need to be set to have functional setup. They can however give a reference for the axial position in a tube. They can also be used by the software to trigger automatic acquisition sequences.

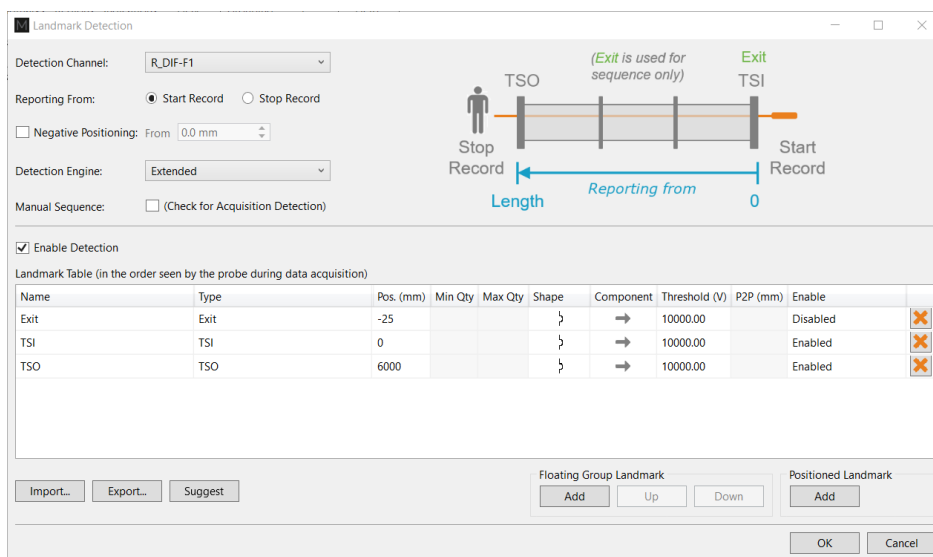

Three landmarks are created if you press on the Suggest button. The channel selected to detect these landmarks should be the lowest frequency absolute channel. The R\_ before the channel stands for Raw. This is the signal of the channel without software filter, rotation, or software gain applied.

You can base the position of your landmarks either on the location where you start to record (usually the tube entrance, opposite from the operator position) or on the place you stop to record (usually the operator side).

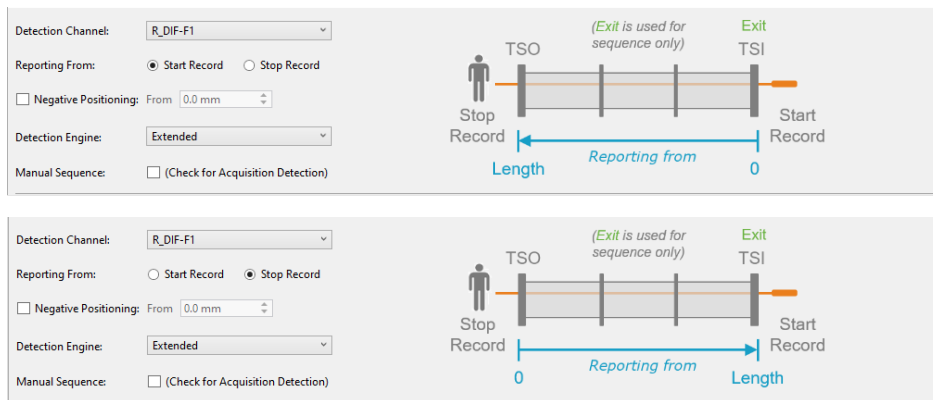

In the above example, the Exit landmark is detected when the probe exits the tube at its outer end. It has a negative position because this event happens before entering the tube. It is enabled only when doing the acquisition.

TS1 is the first tube sheet encountered when the probe is pulled. TSO is the last tube sheet encountered at the end of the acquisition.

Landmark detection can be set up manually by describing the shape, component, and voltage threshold that will trigger the detection. The Shape describes the appearance of the signal when the landmark is reached. If a differential signal shape is chosen, the Peak-to-Peak distance (“P2P”) will also be needed. The Direction is the projection axis (horizontal or vertical) of the Lissajous signal that will be taken to trigger the landmark. And the Threshold is the voltage amplitude threshold.

Landmarks can be calibrated on real signals; in this case, there is no need to change these parameters as they will be automatically measured by the software. It’s important to set the landmark positions as accurately as possible. If the position is not accurately set, the software might prevent their automatic detection since it won’t be at an expected position.

The Type field is a name that associates the calibration point with the landmark. If landmarks share the same Type, they will be calibrated at the same time using the same point and process. To associate two landmarks with the same Type, their signal must be the same. If support plates of the same geometry are present in a bundle, they can share the same Type. In the above example, TS1 and TS2 don’t share the same Type because one is triggered when the probe goes inside the tube and the other is triggered when the probe exits the tube.

The Detection Engine drop-down menu can be set to Legacy or Extended. With the Legacy mode, all the landmarks need to be entered with the right position. The system will look for the exact number of landmarks entered at positions close to those entered in the table. With the Extended mode, the system will look for a number of landmarks between the Qty max and the Qty min. With this mode, the exact number of support plates don’t need to be constant or known.

## REGIONS

The Regions option allows the user to define inclusion/exclusion zones based on Landmarks. This is used to categorize the data to process correctly. For example, they can be useful for restricting the detection of channel saturation to an area within the tube or specify an automatic analysis type for a given region (e.g., under the tubesheets).

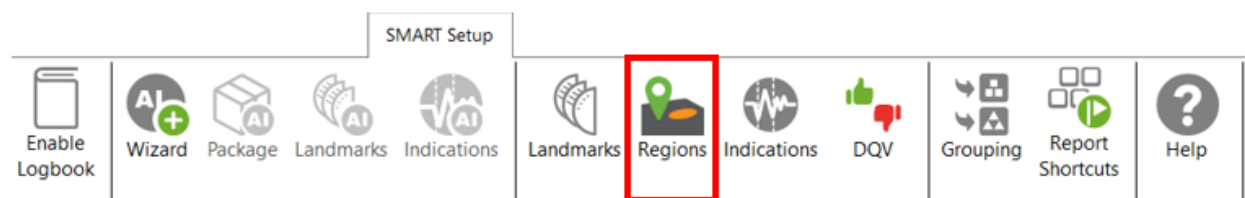

When using the AI Wizard, the parameters of the Region Detection window are set automatically and most of them cannot be modified. You will only be able to change the thickness of the landmark and the

number of support plates. Changing these values will modify the schematic in the regions page to help visualize the exchanger.

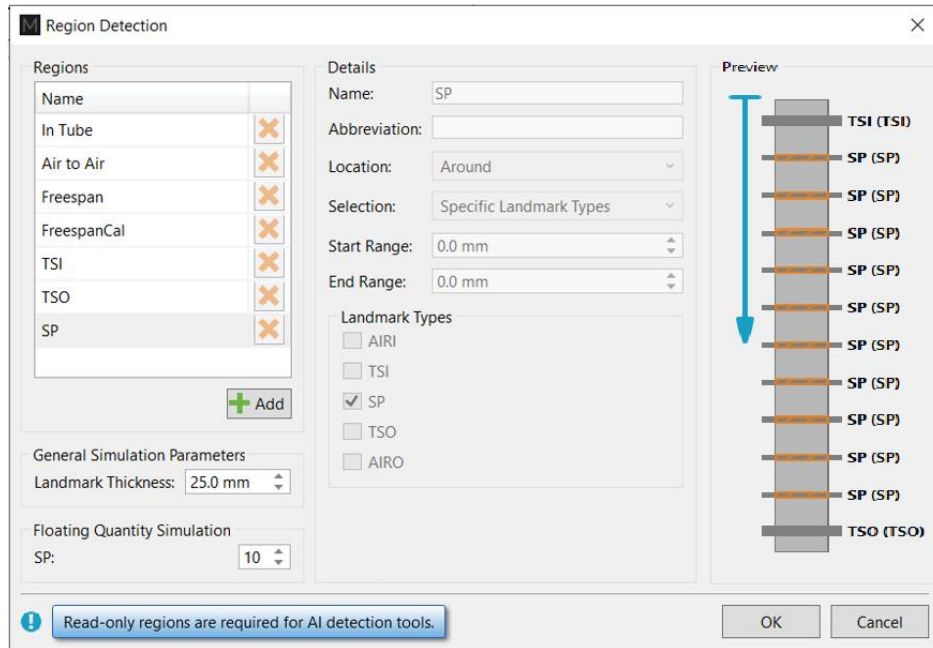

If you are using the conventional detection tools (not AI-based), you can set up the regions according to the automatic analysis tools you will use with the Indications and DVQ buttons (described later).

## INDICATIONS

The Indications module allows the user to define various zones or even waveform types to trigger a certain detection threshold.

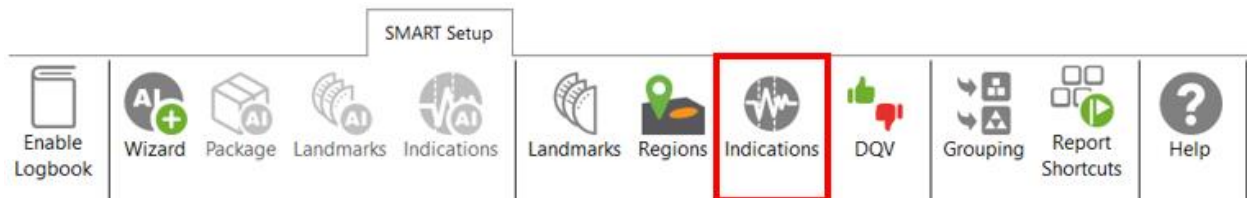

These detection zones can be applied to conventional channels and C-scan channels. The Label is the name that will appear in the Code view (described later).

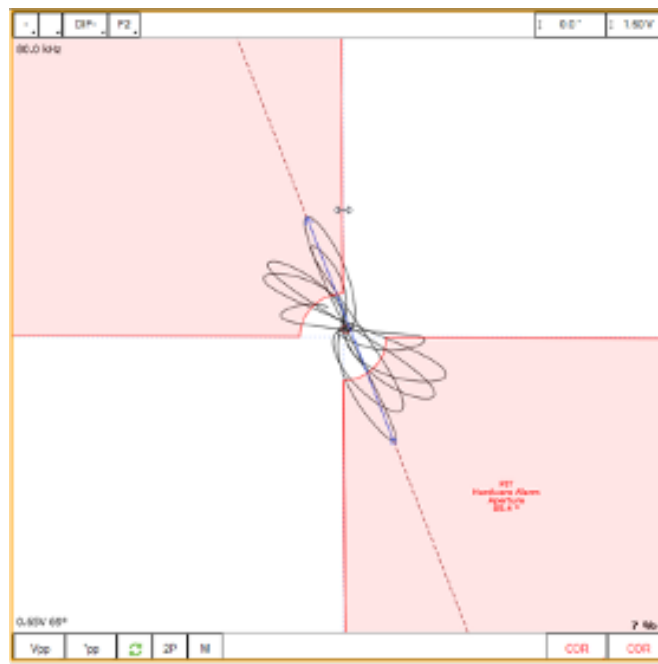
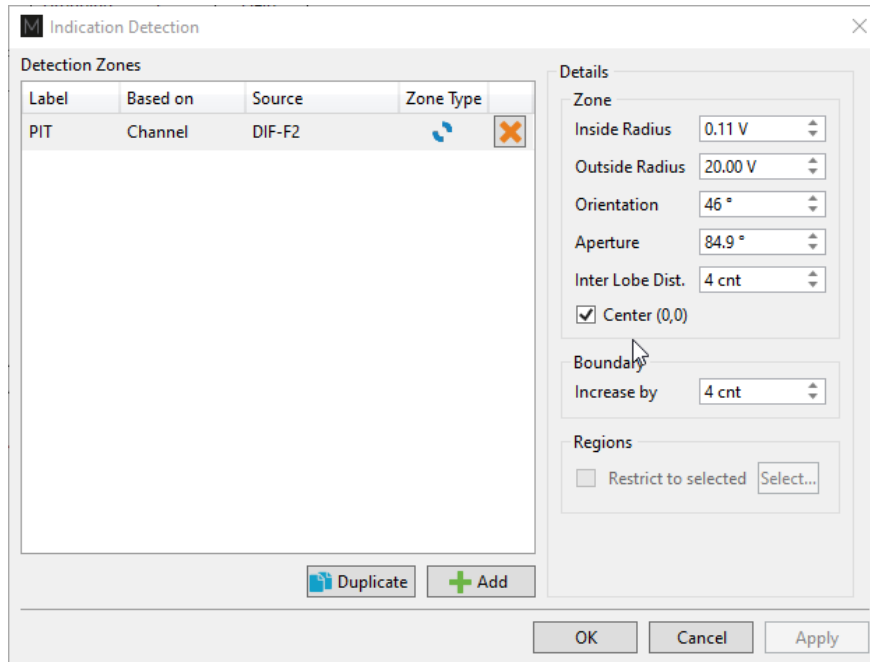

There are five zone types:

	Absolute pie
	Differential pie
	Centered rectangle
	Rectangle
	Over or under a horizontal or vertical threshold

And seven waveform types:



↵+	Up
↵-	Down
↵↕	Down-up
↻	Any direction
↵↕	Up-down
↵↕↕	Down-up-up
↵↕↕↕	Up-down-up-down

Each zone or waveform can be linked to a defined region, and thresholds can be set. The zone types also include the boundary setting to prevent signal oscillation from triggering unnecessary detections.

Detection zone parameters can also be set by clicking on the Lissajous of the used channel and activating the Edit Alarm option on the Current View tab.

The detected indication can be found in the Indication window, which can be activated in the Layout tab.

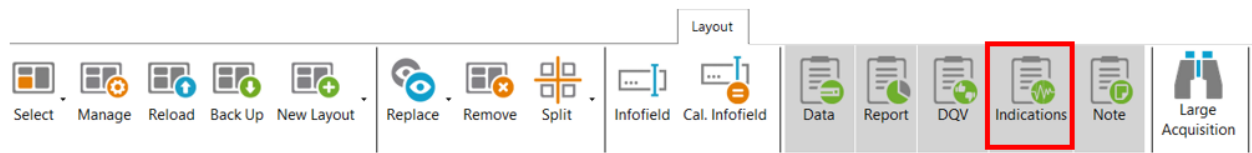

Clicking on an indication in the pane instantly positions the cursor on the selected indication in the Strip chart view. If you click on an indication in the code view (described later), the associated indication is highlighted in the Indications pane.

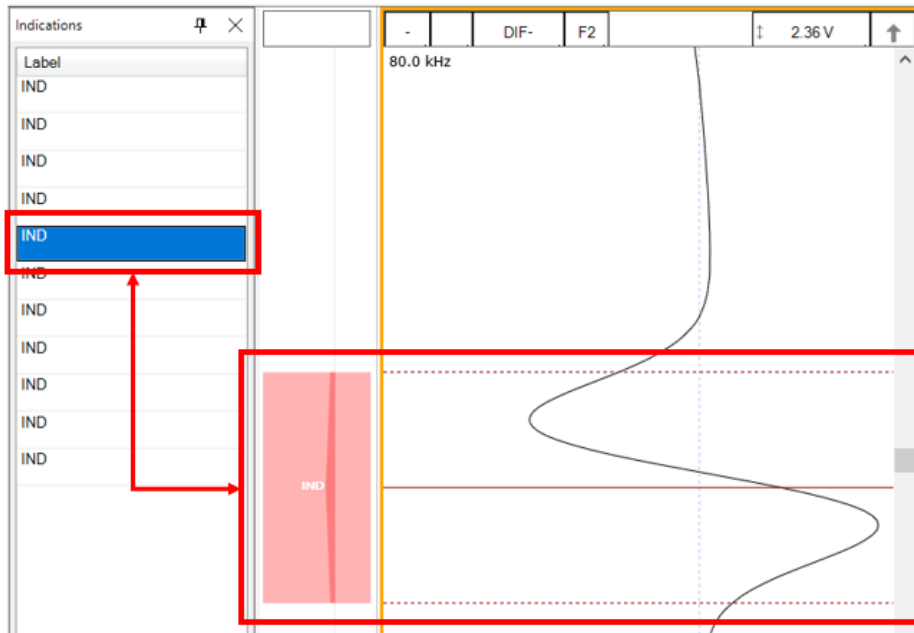

Note that conventional indication detection boxes can be used along AI detection tools. It is recommended to configure them after AI activation to have access to regions automatically defined when going through the AI Wizard.

## DATA QUALITY VALIDATION (DQV)

Data Quality Validation (DQV) allows defining tests to validate the quality of the data.

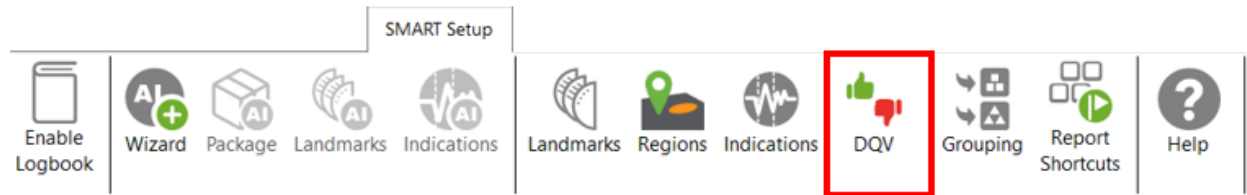

Five test types are available. To add a test, click on the Add button on the DQV page and select the test type with the drop-down menu. Parameters associated with this test can be changed in the Details section of the DQV window.

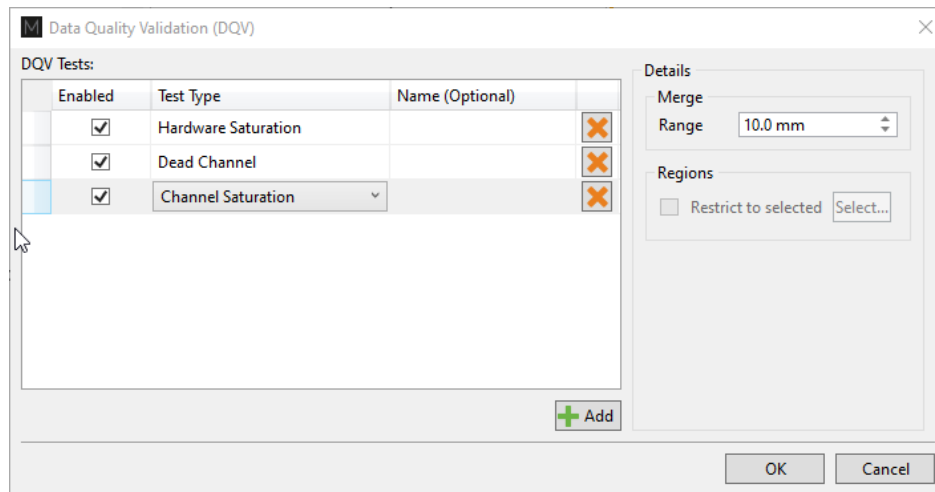

- **Dead Channel:** Verify that channels are reading a signal whose amplitude is above a defined threshold. An amplitude that remains below the threshold throughout the scan indicates a dead channel.
- **Landmark Detected:** Verify the presence of all the selected landmark names in the Details section. To validate full tube-length of straight bundles for ECT bobbin data using AI detection, select this option and check the TSI and TSO landmarks. When AI setup for landmarks is completed and the TWH calibrated, the DQV test will automatically use the AI results to perform the test.
- **Hardware Saturation:** Verify if signal saturation appears on raw channels. The merge field allows grouping a zone together for which the test has failed. This function avoids having many notifications if the test fails several times in one area. This test can be limited to a specific region, for example, the areas inside the tube.

- Channel Saturation: Verify if signal saturation appears on calibrated channels. The merge field allows group a zone together for which the test has failed. This function avoids having many notifications if the test fails several times in one area. This test can be limited to a specific region.
- C-scan Saturation: Verify if signal saturation appears on C-scans. The merge field allows grouping a zone together for which the test has failed. This function avoids having many notifications if the test fails several times in one area. This test can be limited to a specific region.

The results of the DQV tests can be found in the DQV window, which can be activated in the Layout tab.

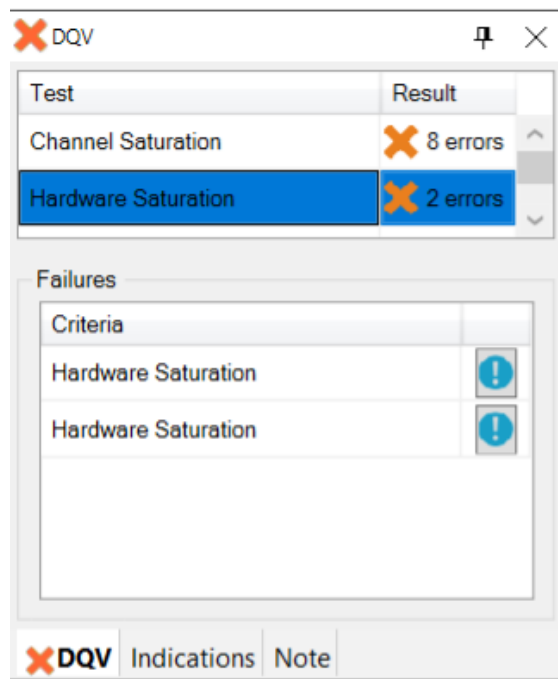
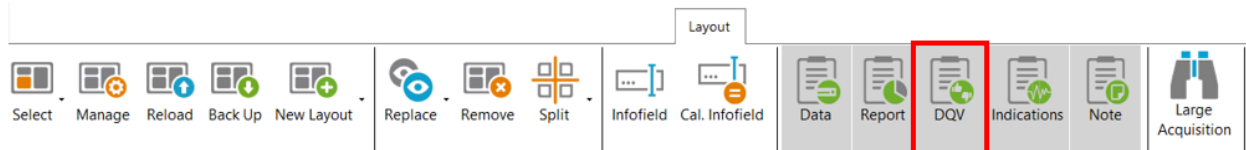

## GROUPING

The grouping tool can help the analyst find critical indications for review as it categorizes and groups the automatically detected indications. This tool is compatible with the AI-based detection engine as well as with conventional rule-based and user-defined indication detection boxes or waveforms.

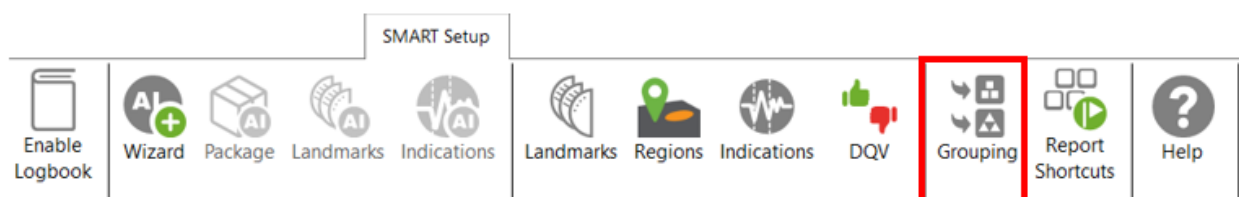

The Grouping menu offers a default configuration with three predefined categories:

- Support Plates
- Critical
- Less Critical

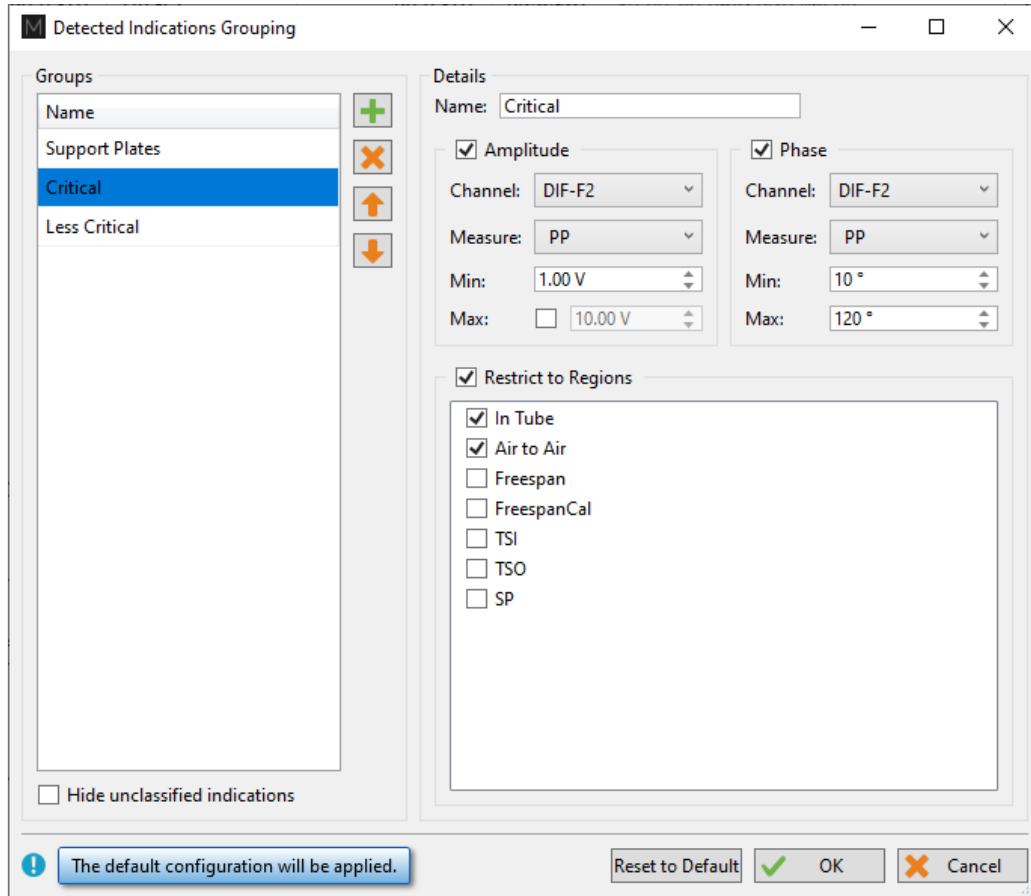

The Details section of each group shows the parameters defining the conditions that must be met for a detected indication to be classified in this group. The user can modify all parameters.

By default, the Support Plates group is configured with the mix channel with a Peak-to-Peak (PP) measurement method, and Max/Min threshold values are set for amplitude and phase. For this group, the criteria are limited to indications detected under the SP regions. As a result, the indications detected under support plates for which all conditions are true will fall into this category.

Critical and Less Critical are two other groups predefined in the Grouping window. Both groups are set on DIF-F2 channel, but with different Amplitude/Phase measurement settings. In both cases, the grouping criteria is restricted to In Tube and Air to Air (for calibration tubes) regions, which covers the full-tube length data.

It should be noted that each automatically detected indication can only be categorized in a single group. Also, the grouping operation is executed according to the order of the groups defined in the Groups list.

Therefore, if a given indication meets all the criteria of the first group, it will be categorized in this group. If not, it will be passed to the following group. If it meets all the criteria of the second group, it will be categorized into this one. If not, it will again be passed to the next group, and so on. If an indication does not meet the criteria of any group, it will be placed in the Unclassified group. This implies that every single indication will be categorized, and none can appear simultaneously in more than one group.

New groups can be created with custom parameters.

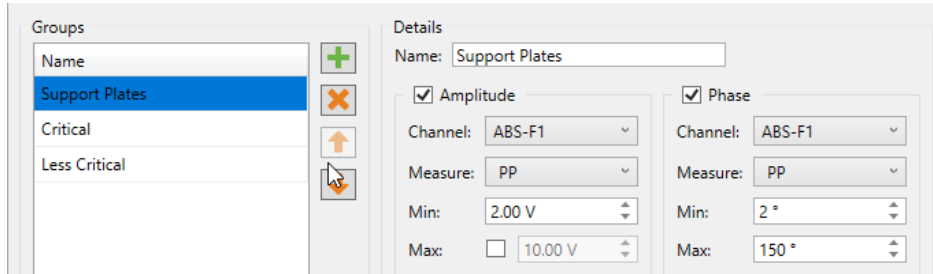

It is also possible to remove a group or use the up/down arrow keys to change the group priority within the list.

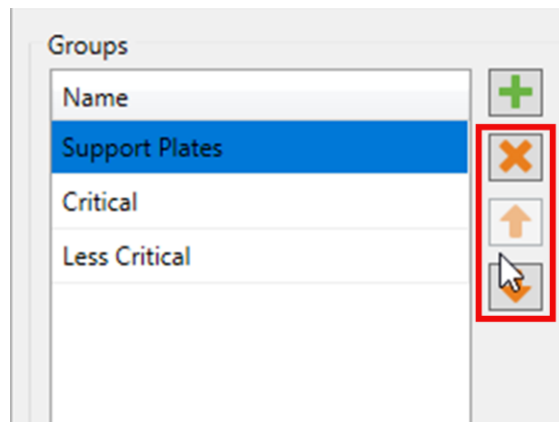

In the Front stage interface, the Grouping results will be displayed in the Indications pane.

Indications		
10 of 10 results		
Label	Ampl.	Phase
<b>^ Critical (4)</b>		
IND	14.15 V	82 °
IND	3.40 V	83 °
IND	2.78 V	106 °
IND	7.06 V	16 °
<b>^ Less Critical (4)</b>		
IND	1.02 V	111 °
IND	1.00 V	40 °
IND	1.27 V	56 °
IND	1.13 V	73 °
<b>^ Unclassified (2)</b>		
IND		
IND		

DQV **Indications** Note

To help the analyst focus on the most relevant detected indications furthermore, it is possible to hide the Unclassified indications. To accomplish this, check the box “Hide unclassified indications” at the bottom of the Grouping menu and click on OK.

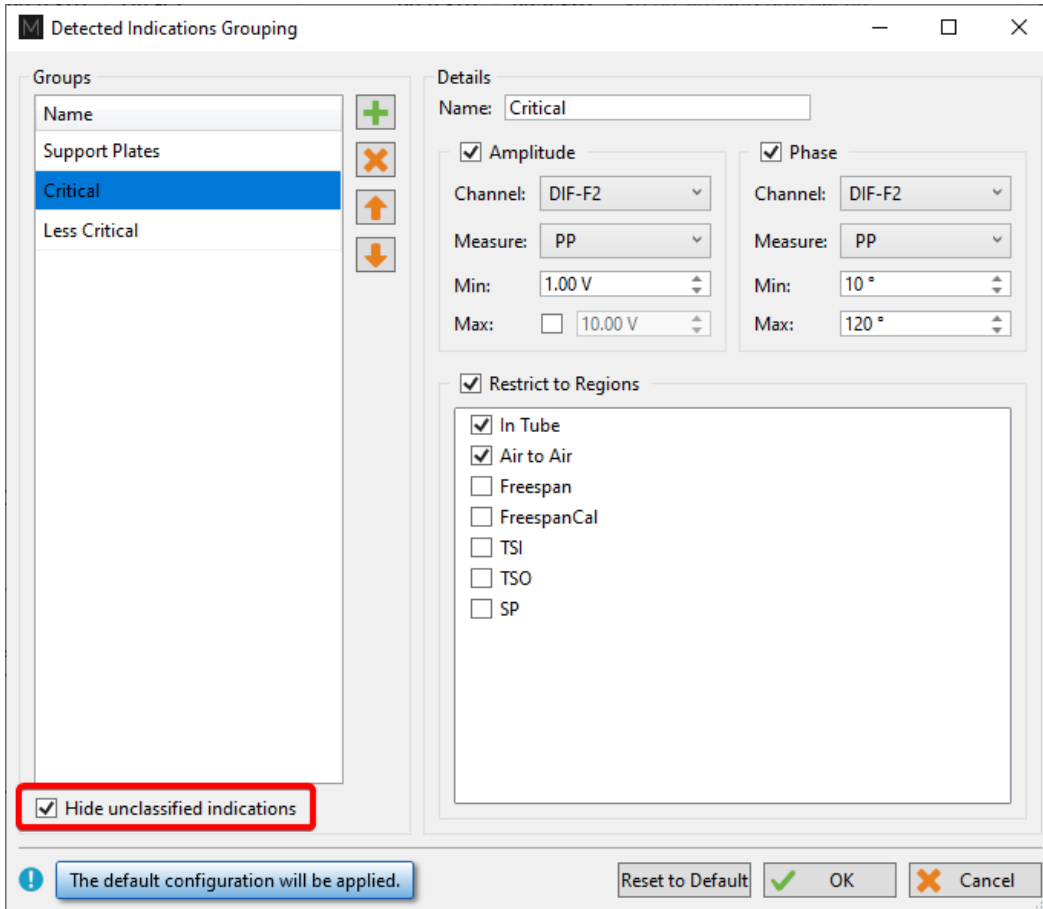

Enabling this option influences the following elements of the software:

- Indications pane;
- Code view;
- Logbook column.

The images below compare them when the Unclassified indications are shown (left) and when they are hidden (right).

When the option is enabled, the Indications pane will not show the “Unclassified” group. The count in the header serves as a reminder to the user that not all indications are currently shown.

Indications 26 of 26 results

Label	Ampl.	Phase
<b>^ Critical (1)</b>		
IND	1.53 V	17 °
<b>^ Less Critical (5)</b>		
IND	1.00 V	14 °
IND	0.93 V	10 °
IND	0.84 V	18 °
IND	0.76 V	17 °
IND	1.20 V	19 °
<b>^ Unclassified (20)</b>		
IND		
IND		
IND		
IND		
IND		

DQV **Indications** Note

Indications 6 of 26 results

Label	Ampl.	Phase
<b>^ Critical (1)</b>		
IND	1.53 V	17 °
<b>^ Less Critical (5)</b>		
IND	1.00 V	14 °
IND	0.93 V	10 °
IND	0.84 V	18 °
IND	0.76 V	17 °
IND	1.20 V	19 °

DQV **Indications** Note

In the Code view, the red markers from the Unclassified indications have been removed.



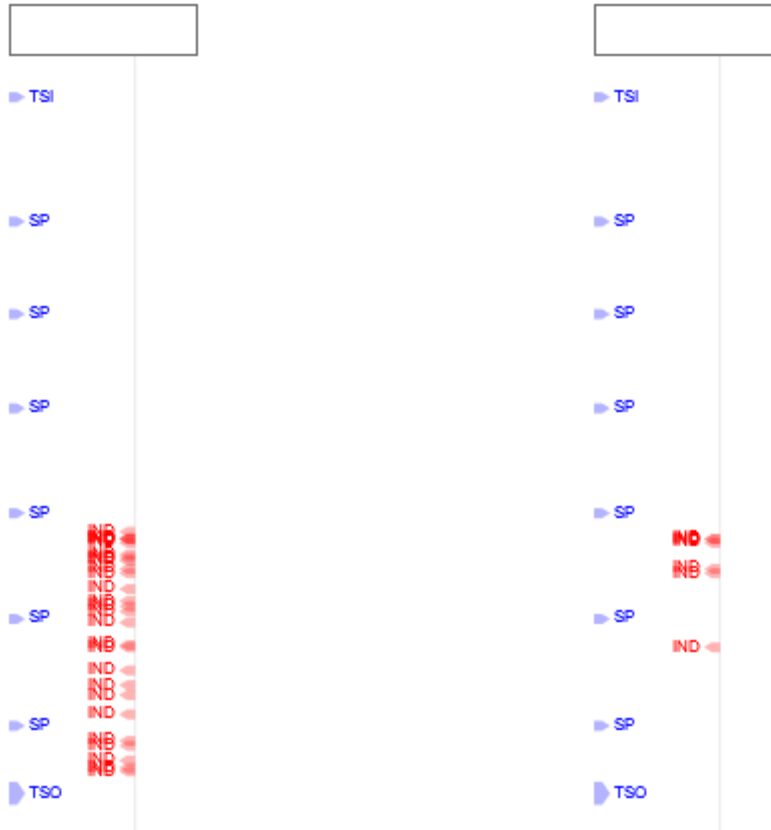

In the data file list, the number shown in the Logbook column represents the number of visible indications, matching the number shown in the header of the Indications pane.

Data		↑	×
7 of 7 data		⌵	
Row	Col		
✓	201000001		
✓	201004005		
✓	<b>201006009</b>	(26)	
✓	201006016		
✓	201024022		
✓	201025017		
✓	201025019		

Data		↑	×
7 of 7 data		⌵	
Row	Col		
✓	201000001		
✓	201004005		
✓	<b>201006009</b>	(6)	
✓	201006016		
✓	201024022		
✓	201025017		
✓	201025019		

## REPORT SHORTCUT

Keyboard shortcuts can be used to make entries in the report. By opening the shortcut window, it is possible to select a channel with a measurement method and to associate an indication with it.

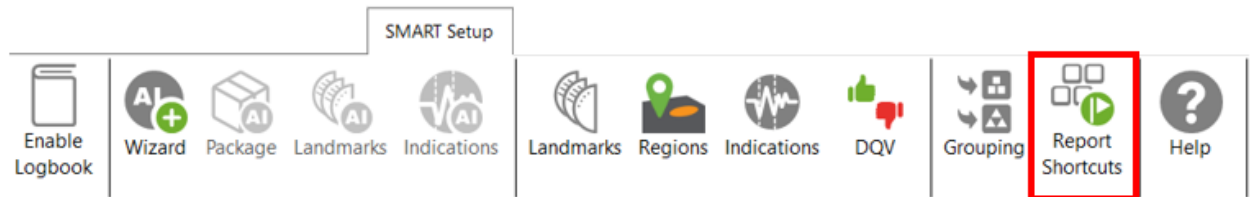

For example, we could use the differential channel F2 with a Peak-to-Peak measurement method to enter pits in the report.

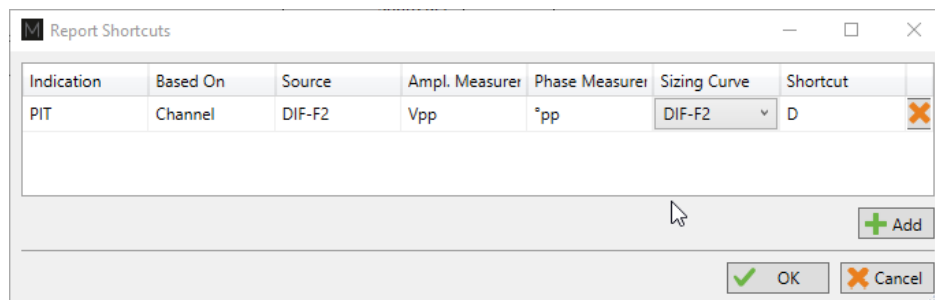

To select a key, press the Shortcut field and press the desired key on your keyboard. It is possible to use a single key or a combination of keys such as ALT+D, for example.

When a report entry is made with the keyboard shortcut, the abbreviation of the type of indication displays momentarily on the corresponding Lissajous.

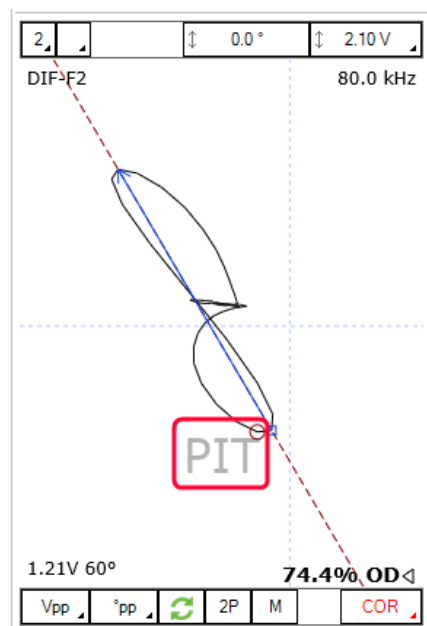

## DATA SCREENING

Data screening set up with the SMART Setup tools can be performed by the two buttons on the left under the Analysis tab.



It is possible to run analysis on a selection of files or all files. The analysis is typically performed on all files when the setup and calibration are adequate. The results are recorded in the logbook and can be viewed in the Data window.

## DATA LIST

Magnifi will save a file for each inspected tube. The file names are defined by creating a list of tubes.

This list can be created in the *Data List* of the *General* tab of the *Backstage*.

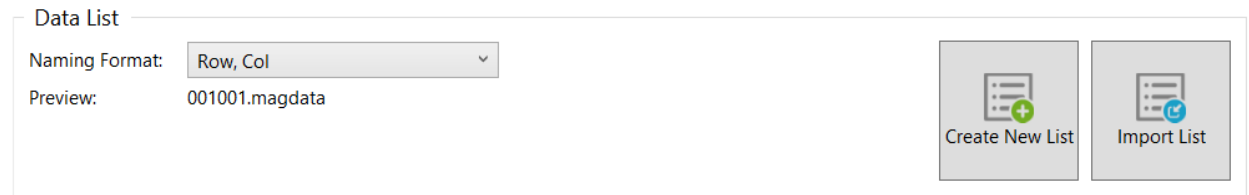

Four options are available to set the filename format:

- 1. Free format:**  
Each file has a custom name. Can also be defined from the Data tab of the Front Stage.
- 2. Prefix:**  
The file name includes a defined prefix followed by a sequential number.
- 3. Row, Col:**  
Row number, Column number. Mostly used for tubing inspections.
- 4. Zone, Row, Col:**  
Zone number, Row number, Column number. Mostly used for tubing inspections.

Click on the *Create New List* button. The displayed window will be different depending on the chosen filename format.

For the *Row, Col* option, enter the number of rows, the starting row number and row interval. You can then enter the number of tubes per row in the *Nb. of Columns* fields of the table. Click on *Create* to generate the list of tubes. You can also use the *Create & New* button to add another set of tubes to your list.

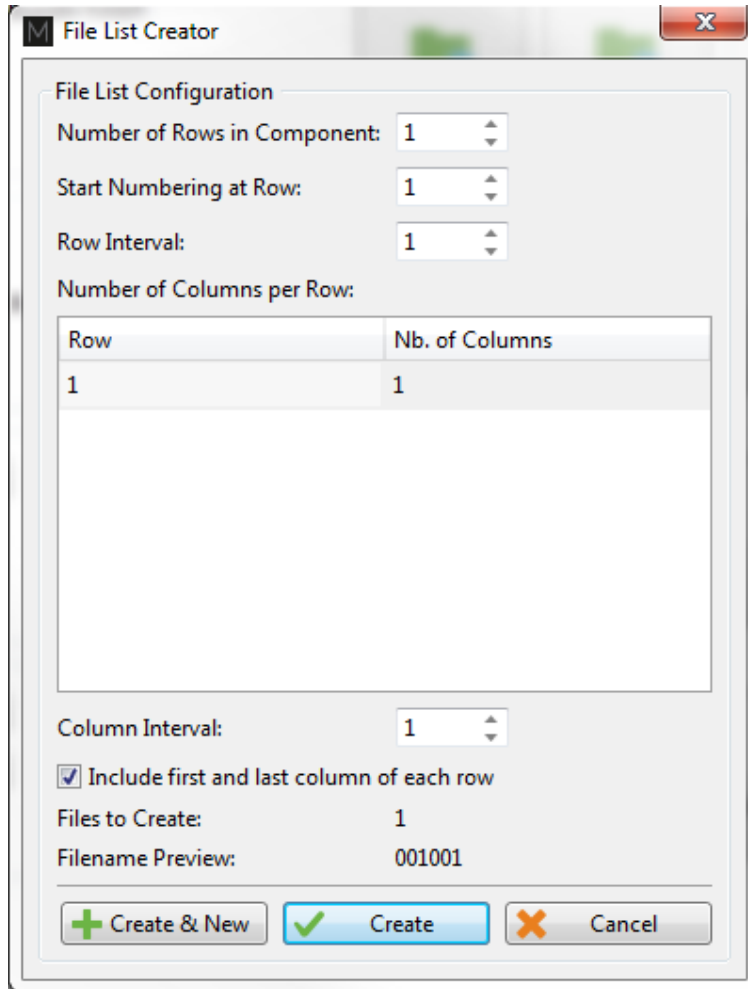

The same principles apply to the other file formats, except for the *Free format* option for which the file name(s) needs to be entered manually in the *Data* window of the *Frontstage*.

The tube list can also be imported from another project using the *Import List* button. The tube list file can be found in the *Inspection* folder. It is also possible to import a list created in the *TubePro* software (available from Eddyfi).

## PERFORMING AN ACQUISITION

1. If you are in the *Backstage*, move to the *Frontstage* by clicking on *Start/Resume* button.
2. Click on the *Connect* button under the *Instrument* tab. This will open the *Instrument configuration* page. Click on the line showing the instrument to which you want to connect, and then click *Connect*.



Note: Your Ectane firmware version may not match the version of Magnifi you are using. If this is the case, a red and white X icon will be shown in the *Status* field of the *Instrument connection* window. To download a matching version to your Ectane, click on the *Config.* button and then click the *Send firmware to the instrument* button of the *Instrument configuration* window.

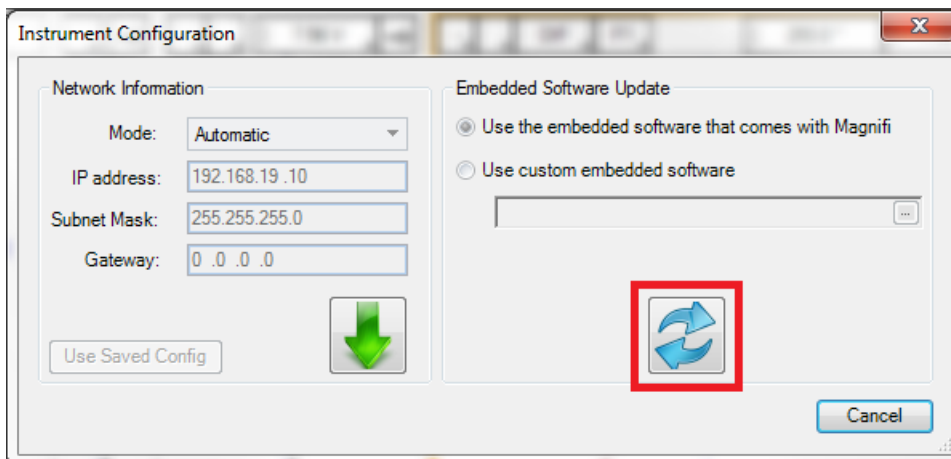
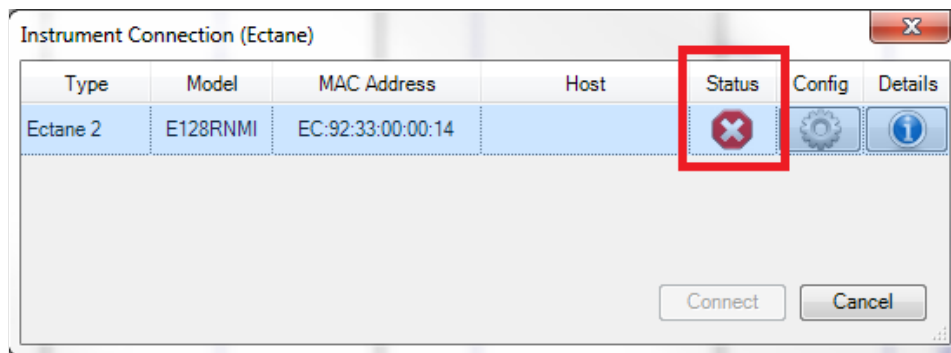

Two (2) acquisition modes are available in Magnifi: *Setup Mode* and *Acquisition Mode*. *Setup Mode* is used to scan your calibration tube and make the necessary adjustments on your setup without saving the data automatically. *Acquisition mode* is used for the inspection - in this mode, the software automatically saves the acquired data using file names based on the tube list.

- For the calibration phase, go to *Setup Mode* by clicking on the *Setup Mode* button under the *Home* tab. This mode is active when the *Setup Mode* button is grayed.

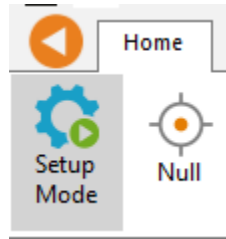

- Plug the bobbin probe on the Ectane 4-pin connector.
- Bring the probe head in a clear area in your standard and balance the probe by clicking on the *Null* button under the *Home* tab, or press F6 on your keyboard.
- Push the probe head all the way through the tube so that it exits the tube.
- Start the acquisition by clicking on the *Acquire* button under the *Home* tab or by pressing the F2 on your keyboard.
- Pull the probe at approximately 12"/s (300 mm/s)
- When it's done, press the *Stop* button or F2 again on your keyboard.

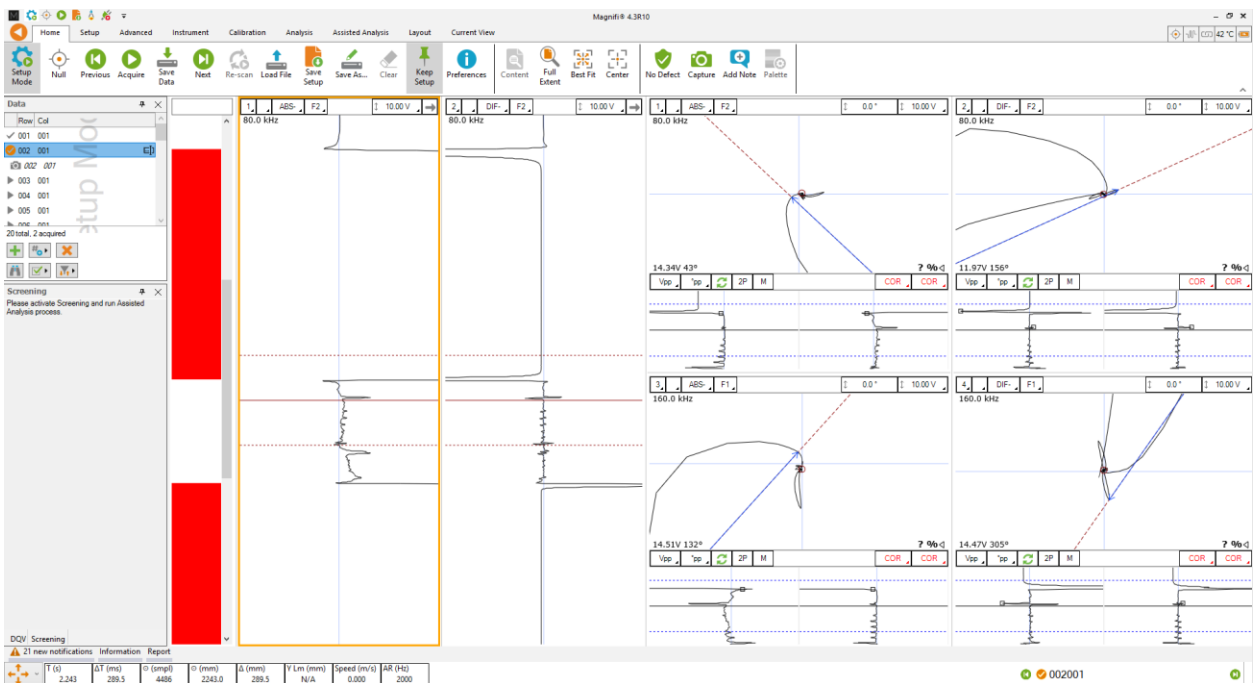

Note that a red zone in the code pane means that at least one of the raw signals is saturated. This is usually the case when your probe is out of the tube.

## VISUALIZING THE DATA

Multiple options are available to select your data and to measure it. The following describes useful functions to do so:

## DISPLAYED CHANNEL

There are four buttons at the upper right corner of the Strip charts and Lissajous windows. These buttons are used for the channel selection.

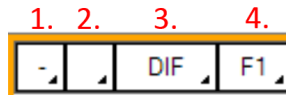

1. Links Strip charts and Lissajous to the same channel. For instance, if a Lissajous and a Strip chart are both set to 1, setting the Lissajous to DIF-F1 will also set the associated Strip chart to this channel.

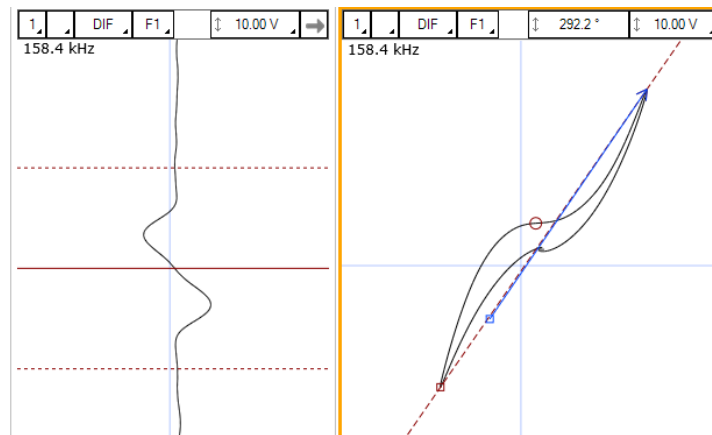

2. Clicking on the corner with the black triangle gives the list of available channels. Click on the desired channel to select it. Right-click or Left-click on this button to switch to the following or previous channel in the list.

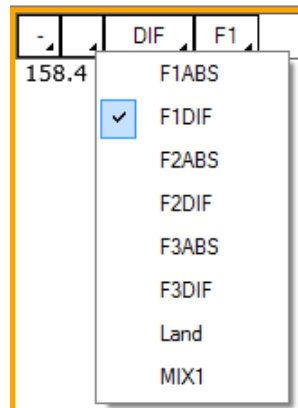

3. Same principle as 2., but for the type of channel only (absolute or differential).
4. Same principle as 2., but for the frequencies only.

## STRIP CHART AXIS ORIENTATION

The Strip charts are projections of the Lissajous on the vertical or horizontal axis. To switch from one axis to another, click on the box showing an arrow at the upper right corner of the Strip chart.

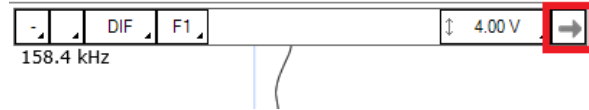

## ZOOMING

On the strip chart, hold the right button of your mouse and drag on the zone of interest to zoom in this section.

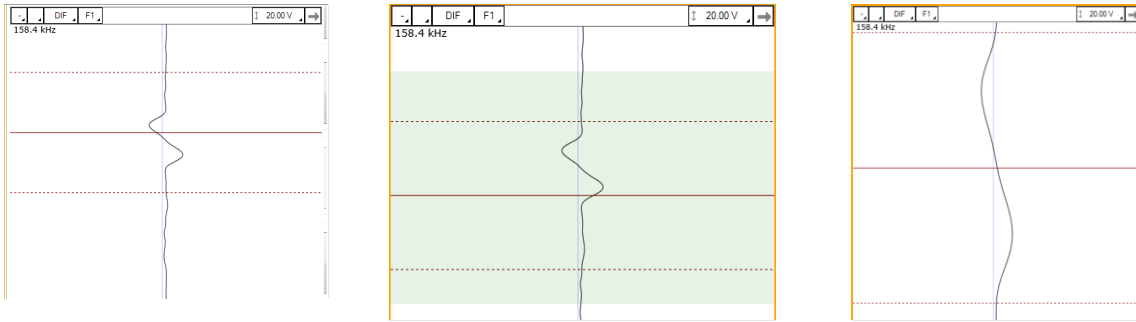

To zoom out, right-click on the Strip chart and select *Previous Zoom* or *Full Extent*.

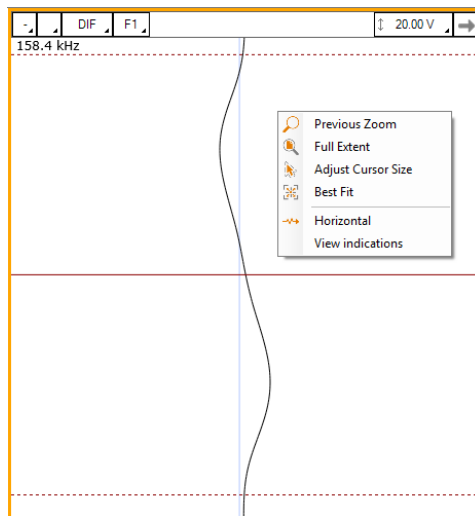



## ADJUSTING THE CURSOR LENGTH

On a Strip chart, the cursor is divided by 3 lines. The dotted lines represent the limit of your cursor and the full line is the center of what you have selected.

Only the portion of data between the dotted lines will be shown in the Lissajous.

To adjust your cursor length, hover your mouse over the dotted line, and click and drag the left mouse button. This will adjust the 2 dotted line symmetrically. To adjust only one dotted line, do the same operation, but with the right button of your mouse.

## ADJUSTING THE SCALE

The scale of a window (Lissajous or Strip chart) can be modified by clicking on the scale button with the left button (decrease scale) or the right button (increase scale) of your mouse.

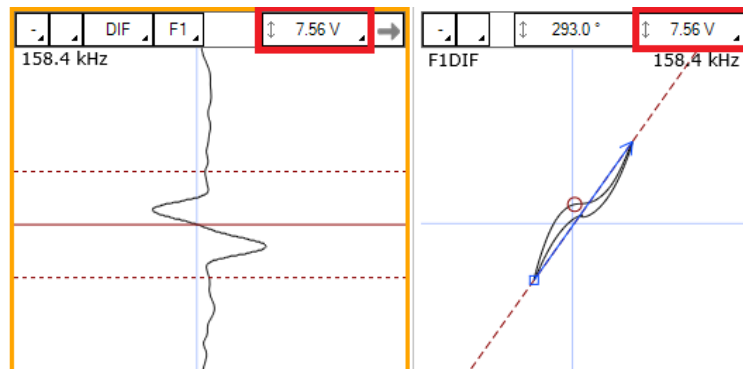

Another way to modify the scale is to click and drag (up or down) the right button of your mouse on the scale button.

## MEASUREMENT METHOD

The buttons at the lower left corner of the Lissajous windows are used to select the measurement method. A short description of the measurement methods can be found in the above calibration section of the setup wizard.

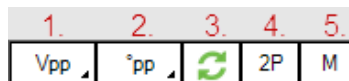

1. Clicking on the corner with the black triangle gives the list of measurement method for the amplitude of the signal. Click on the desired method to select it. Right- or left-click on this button to select the next or the previous method in the list.
2. Same as 1., but for the phase measurement.
3. Remove  $180^\circ$  to the measured phase. This option can be used if the software doesn't measure the phase with the right orientation.
4. Take the same two points in time to take the measurement in the other Lissajous.
5. Allow a manual measurement of the signal. Click and drag the left button of your mouse to draw a vector on your Lissajous.

## LISSAJOUS ROTATION AND PANNING

The signal in a Lissajous can be rotated by holding CTRL on the keyboard while holding the left button of your mouse and dragging it around the rotation axis. Note that this operation cannot be performed on the raw channels since these channels have no gain or rotation applied, by definition. Also, rotating the signal will affect your calibration. If you perform this operation, make sure to recalibrate afterwards.

The origin point can also be moved by holding the left button of your mouse on the Lissajous background and by dragging it in the desired direction.

## DATA CENTERING

To center the data in the different windows, put your cursor at a point where you want the data to be centered and use the spacebar on the keyboard.

## CALIBRATION AND SIZING CURVES

---

### CALIBRATION

The following section describes how to calibrate your probe.

1. Go to the *Calibration* tab and click on the *System* icon.
2. Select Channel in the calibration window.
3. In the Strip chart, select the signal to calibrate and adjust the cursors to see only the desired signal.

Note: The system calibrates the signal with a measurement method that is defined in the calibration part of the setup (previous step). It is recommended to read the data with the same method as the system when you selected your calibration point. This will allow you to see what the system is using to make its calibration. If, for some reason, the measurement is not taken properly, you may be able to readjust your cursor to have the right measured values.

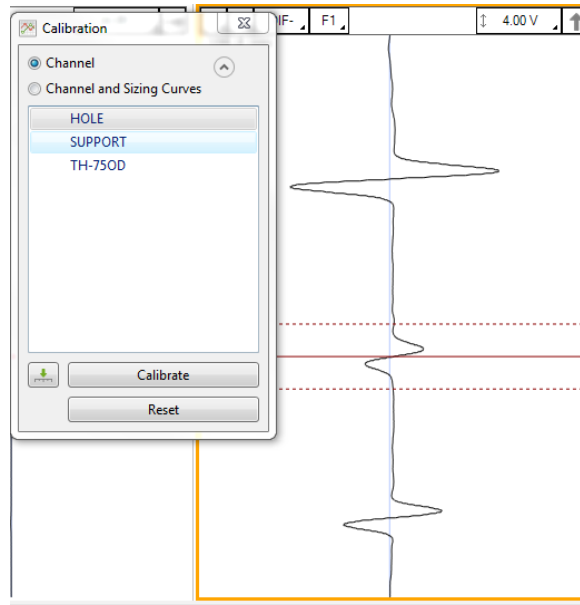

4. Select the signal name in the list.
5. Click on the green arrow button to associate the measured signal to the calibration point.
6. If more than one calibration point is present in the list, repeat step 3, 4 and 5 for each one.
7. When all your calibration points are check-marked, click on the *Calibrate* button.

## SIZING CURVES

The following section describes how to build your sizing curves.

1. Go the calibration tab and click on the *Sizing curve* button.
2. Select *Channel and Sizing Curves* in the *Calibration* window.
3. Select the signal in your Strip chart and adjust the cursors to see only the desired signal.

Note: The system calibrates the signal with a measurement method that is defined in the calibration part of the setup (previous step). It is recommended to read the data with the same method as the system when you selected your calibration point. This will allow you to see what the system is using to make its calibration. If, for some reason, the measurement is not taken properly, you may be able to readjust your cursor to have the right measured values.

Also, when points are entered in the sizing curves, the interpolated value is displayed on the Lissajous to show the defect size. To have the correct interpolated point, the measurement method also needs to be the same as the one used for the sizing curve. To change the measurement method, click on the icons at the bottom left of the Lissajous.

4. Select the signal name in the list.
5. Click on the green arrow.
6. Redo the previous steps for all the other indications in the list.
7. Click on the *Calibrate* button.

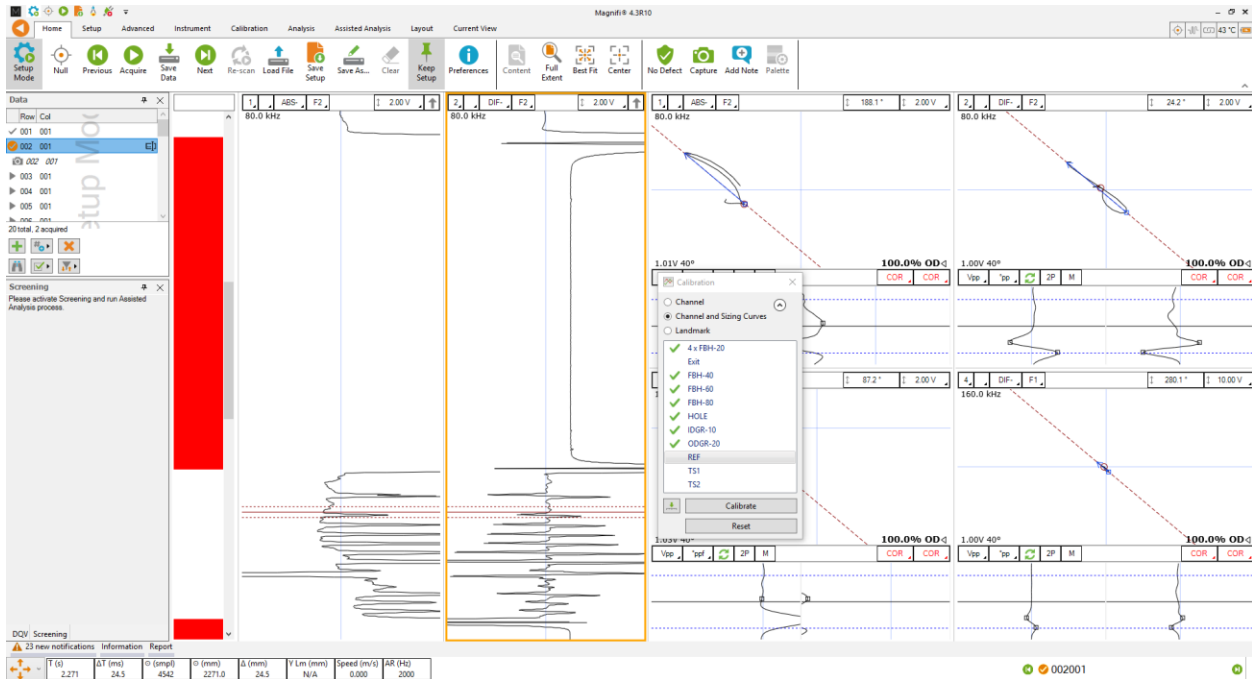

Error messages after creating the phase sizing curves may appear. The main cause of these errors is the measurement direction.

The image below shows two different measurements. On the left, you can see that the measurement arrow is pointing towards the liftoff signal. In this case, the measured phase is rotated of 180° from the right value. When one or more points were measured in the wrong direction, Magnifi cannot build the sizing curve and will generate an error message. Note that you won't have this issue with an absolute channel if you're using the *average peak* measurement method.

In the image on the right, the arrow is pointing from the liftoff signal to the defect signal, which is correct. However, in this picture, the arrow starts quite far from the middle of the liftoff variation signal, which will cause an error in the measurement. In this case, we suggest you move the cursors until your measurement is taken from a point near the base of the signal.

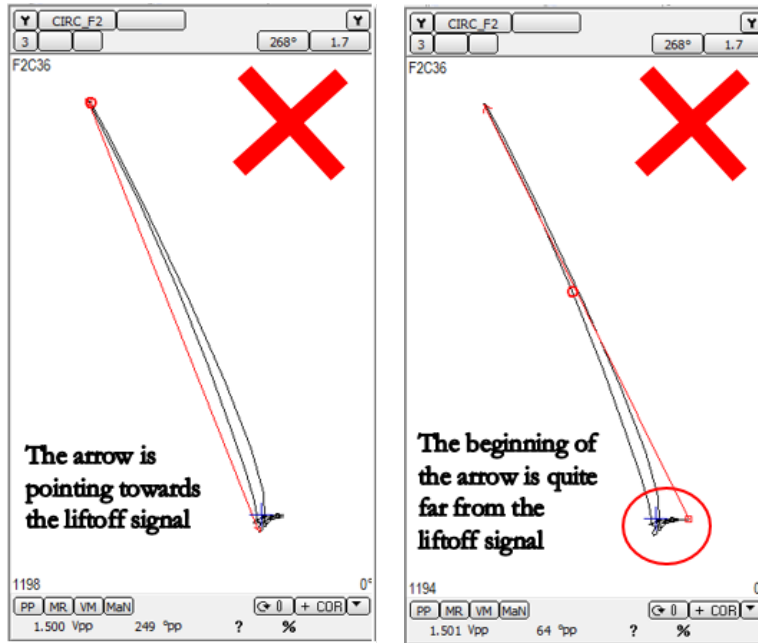

To adjust your sizing curves and remove the error messages, go the *Calibration* tab, and click on *View Curves*.

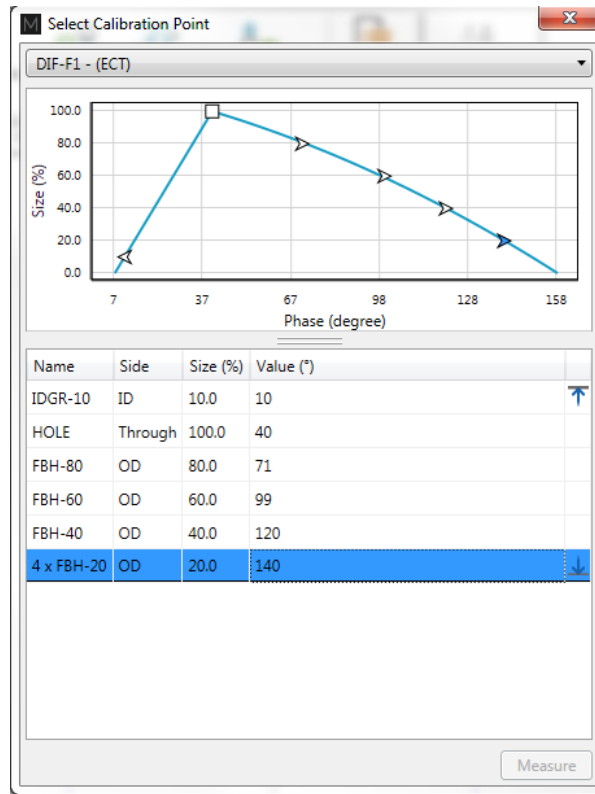
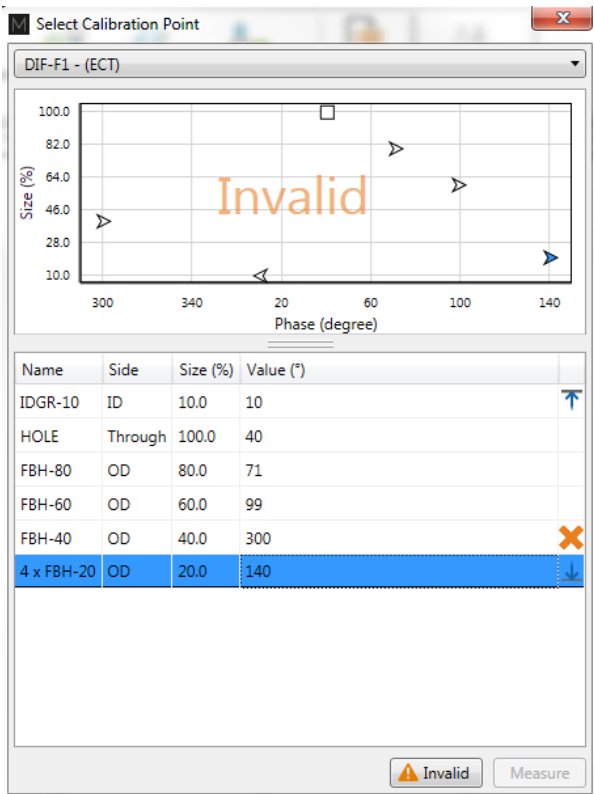

The sizing curve window will appear. Each sizing curve you asked Magnifi to create will be listed in the drop-down menu. If an invalid notification is present on the curve, it means that you either haven't entered the sizing points yet, or that Magnifi failed to create the curve. To adjust the sizing curve manually, enter the value in the table.

In the above example, the entered phase angle for the 40% defect is 300°, but the correct phase angle for the 40% defect is 120°. The 40% defect has an 180° bias due to an incorrect measurement direction. In this case, we can simply change the angle value from 300° to 120° in the table to fix the sizing curve.

To validate the curves, you can bring the measurement cursor over one of the calibrated flaws in the Lissajous and get an estimation of the depth (shown in the lower right corner). If the flaw size does not appear, it means that you are not in a channel where a sizing curve was set.

## LANDMARKS

The following section describes how to calibrate your landmarks.

Go to the calibration tab and click on the Landmark icon. Calibrate the landmarks shown in the *Landmarks* window the same way you calibrated the sizing curve(s) points. You can use the *Land* channel to do so. The positions of TS1 and TS2 are described in the *Landmark* window in the *Setup* tab (TS2 is the farside tubesheet, that is, the first one encountered by the probe during data acquisition; TS1 is the nearside tubesheet).

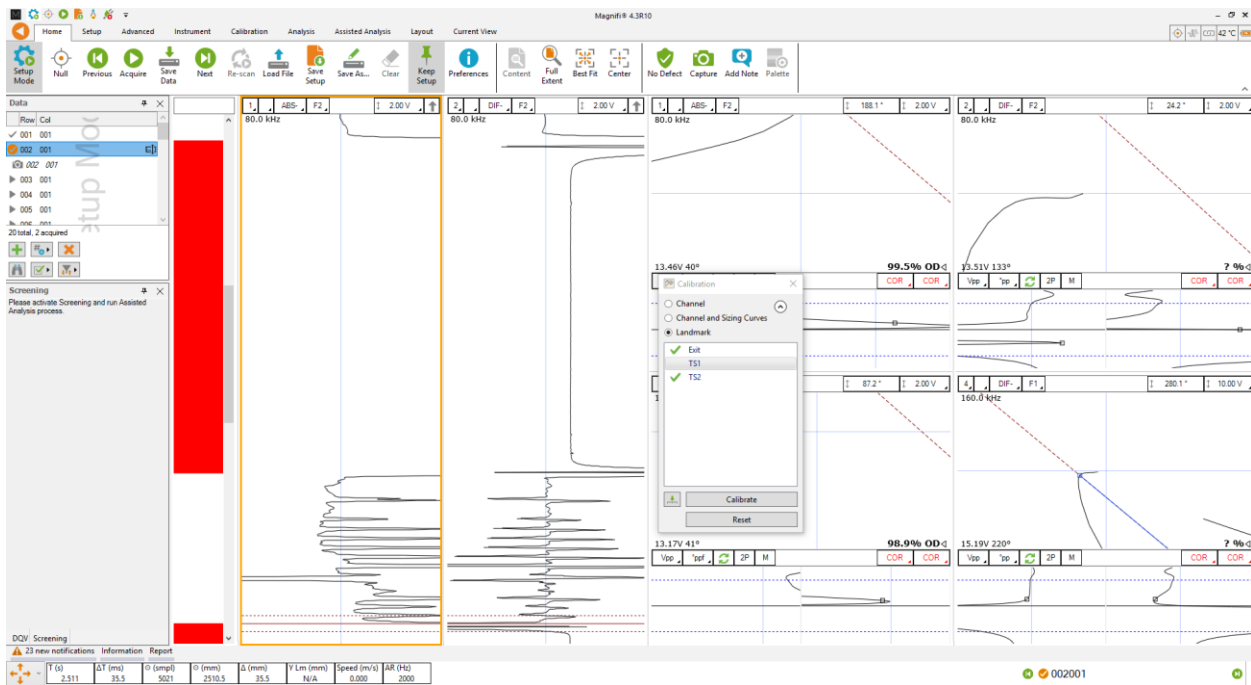

Once the landmarks are calibrated properly, the system should be able to recognize them automatically.

Note that in order to calibrate the default *Exit* landmark, a datafile that includes the probe exit at the far end of the tube is needed.

## SAVING YOUR SETUP

Once all your setup adjustments are done, you can save your setup by clicking on the *Save Setup* button under the *Home* tab. The displayed window will allow you to give an appropriate name to your setup and to save it at the desired locations. The save location is, by default, your inspection file. Note that when data is saved, the setup is also saved with it.

You can also save the data of your calibration standard by clicking on the *Save As* button under the *Home* tab.

## INSPECTION

---

### STANDARD ACQUISITION

The following section describes how to perform an inspection.

1. Connect Magnifi to your instrument.
2. Enter into *Acquisition Mode* by clicking on the *Setup Mode* button under the *Home* tab. *Acquisition Mode* is activated when the *Setup Mode* button is not grayed.
3. Plug the bobbin probe into the Ectane 4-pin connector.
4. Bring the probe head to a clear area in your standard and balance the probe by clicking on the *Null* button under the *Home* tab, or press F6 on your keyboard.
5. Push the probe all the way through the tube until it exits the far end.
6. Start the acquisition by clicking on the *Acquire* button under the *Home* tab or by pressing the F2 on your keyboard.
7. Pull the probe towards you at a constant speed until it exits the tube.
8. When finished, press the *Stop* button or again F2 on your keyboard.
9. Repeat steps 4,5,6 and 7 for all the tubes to inspect in your bundle.

### MANUAL SEQUENCE

An inspection can also be done by using the manual sequence. This feature is based on the landmarks and can trigger the acquisition start/stop and the data recording automatically. At least two (2) landmarks are needed to use this feature. These landmarks can be created by using the Landmarks button under the SMART Setup tab.

To set the manual sequence:

1. Click on the *Manual Sequence* button under the *Calibration* tab.
2. If a warning message is shown in this window, change the parameters until no warnings are shown. The system will progress through the different windows to guide you.
3. Click on *Settings ...*

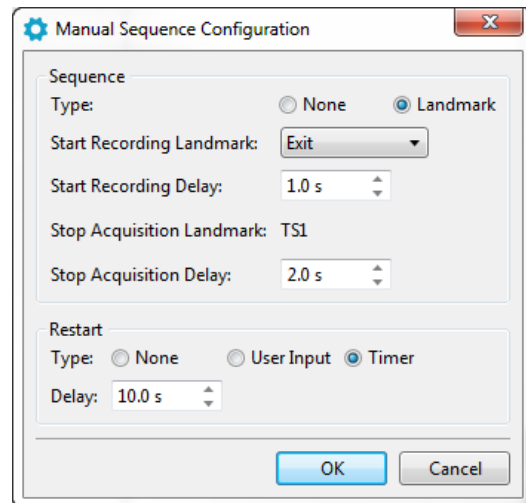
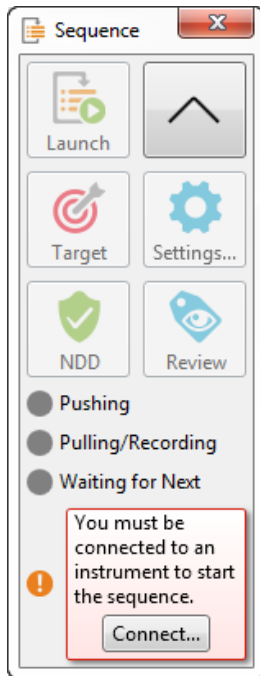

4. Select *Landmark* in the *Type* section.
5. In the drop-down menu, choose the Landmark that will initiate the data recording. If you keep the default landmarks, you can select the *Exit* landmark that will be triggered when the probe goes out of the tube when the probe is pushed.
6. You can enter a delay to start the acquisition after the first landmark is detected (*Start Recording Delay*) and a delay to stop the acquisition when the last landmark is detected (*Stop Acquisition Delay*).
7. Two options are available to restart the acquisition: The user can either push a button or use a timer. Select the desired option in the *Restart* section.
8. Click on *OK*.

To use the manual sequence:

1. Connect Magnifi to the instrument.
2. Enter into *Acquisition Mode* by clicking on the *Setup Mode* button under the *Home* tab. *Acquisition Mode* is activated when the *Setup Mode* button is not grayed.
3. Plug the ECT probe into the Ectane 4-pin connector.
4. Bring the probe head to a clear area in your standard and balance the probe by clicking on the *Null* button under the *Home* tab, or press F6 on your keyboard.
5. Open the *Sequence* window by clicking on the *Manual Sequence* button under the *Calibration* tab.
6. Put your probe in the tube to inspect and click on the *Launch* button. This will start the data acquisition.
7. Push the probe until it exits the far end of the tube. If set correctly, Magnifi will recognize the landmark and this will initiate the data recording.



8. Pull the probe towards you until it exits the tube. This will trigger the last landmark detection that will stop the data recording.
9. Acquisition restart:
  - a. If you selected *User Input* in the settings of the *Manual Sequence Configuration*, the system will wait for the user to enter information on the tube to restart the acquisition. Click on *NDD* or *Review*. This will add a tag to the inspected tube and it will restart the acquisition. Repeat steps 6, 7 and 8 for all the tubes to inspect.
  - b. If you selected *Timer* in the settings of the *Manual Sequence Configuration*, a countdown will trigger after the last tube acquisition was taken. The acquisition will start after this time has elapsed. Redo step 6 and 7 for all the other tubes to inspect in the bundle.

When doing your inspection, you may encounter some tubes that can't be scanned completely. If this is the case, you won't be able to catch the landmark that triggers the data acquisition at the end of the tube. In this situation, you can click on the Target button in the *Sequence* window to start the data recording.

## DATA LIST MANAGEMENT

For each acquisition, Magnifi can automatically save a file using the file name defined previously in the *Data list* section of this document. To do so, checkmark the *Automatic File Recording* option that can be found under the *General tab* of the *Preference* menu of the *Backstage*.

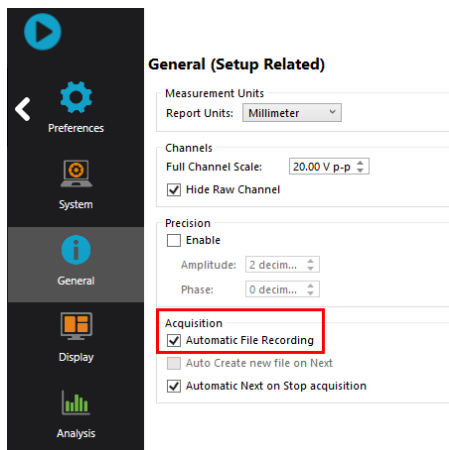

The list of tubes is also shown in the *Data* window.

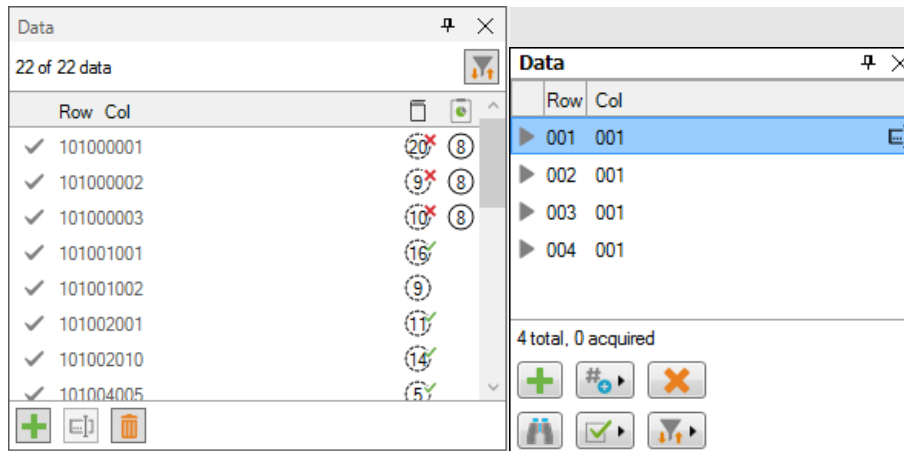

A common practice is to rescan your calibration tube and balance the probe periodically. You can save this new calibration tube data by adding a new tube in your tube list (999 001 for example). Or you can go out of acquisition mode, scan your tube, and click on the *Save Cal As...* button under the *Calibration* tab to save your data. You can then go back to *acquisition mode* to continue your inspection and to automatically save the acquired tubes in your bundle.

Once a tube has been scanned, the "play" icon next to the file name will be replaced with a checkmark icon.

You can rescan a tube by selecting its name in the list and by clicking on the *Rescan* button in the *Home* tab.

A tube name can be changed by right-clicking on its name and by selecting the *Rename* option.

## LOADING A FILE

1. First disconnect your computer from the Ectane by clicking on the *Disconnect* button under the *Home* tab.
2. You can load a file by double-clicking on the file name in the *Data* window. It can also be done by selecting the file in the list and by clicking on the *Load* button under the *Home* tab. Note that double-clicking on a tube when you are still connected to an instrument will initiate data acquisition.
3. You can open the next or the previous file in the list by clicking on the *Previous* or *Next* button of the *Home* tab.

The data files can be filtered by using the *Filter* button of the *Data* window.

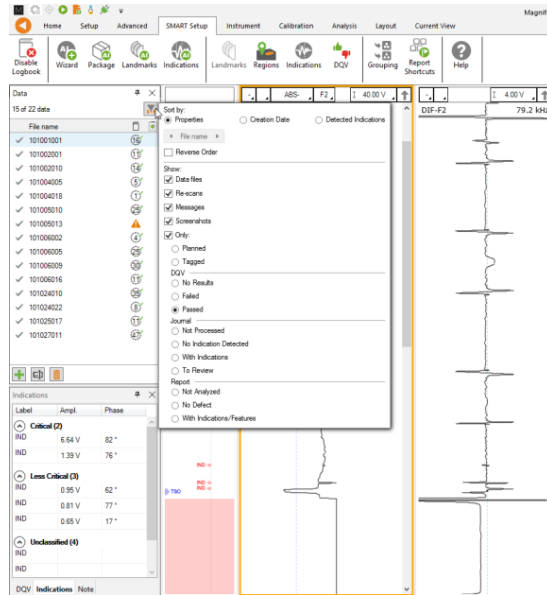

## REPORT

### INDICATIONS

The two *Indication* buttons at the lower corner of the Lissajous windows can be used to add an entry to the report. These two buttons indicate the code that is associated with the defect being entered. Both buttons are identical, but can be set to identify different flaws.

To add an indications to the data:

1. Select the defect signal in the strip chart and adjust the cursor so that the signal in the Lissajous includes only the defect signal.
2. Then, click on the red triangle in the corner of the *Indication* button to select the type of defect to enter.
3. Click on the defect button to add an entry to the report.

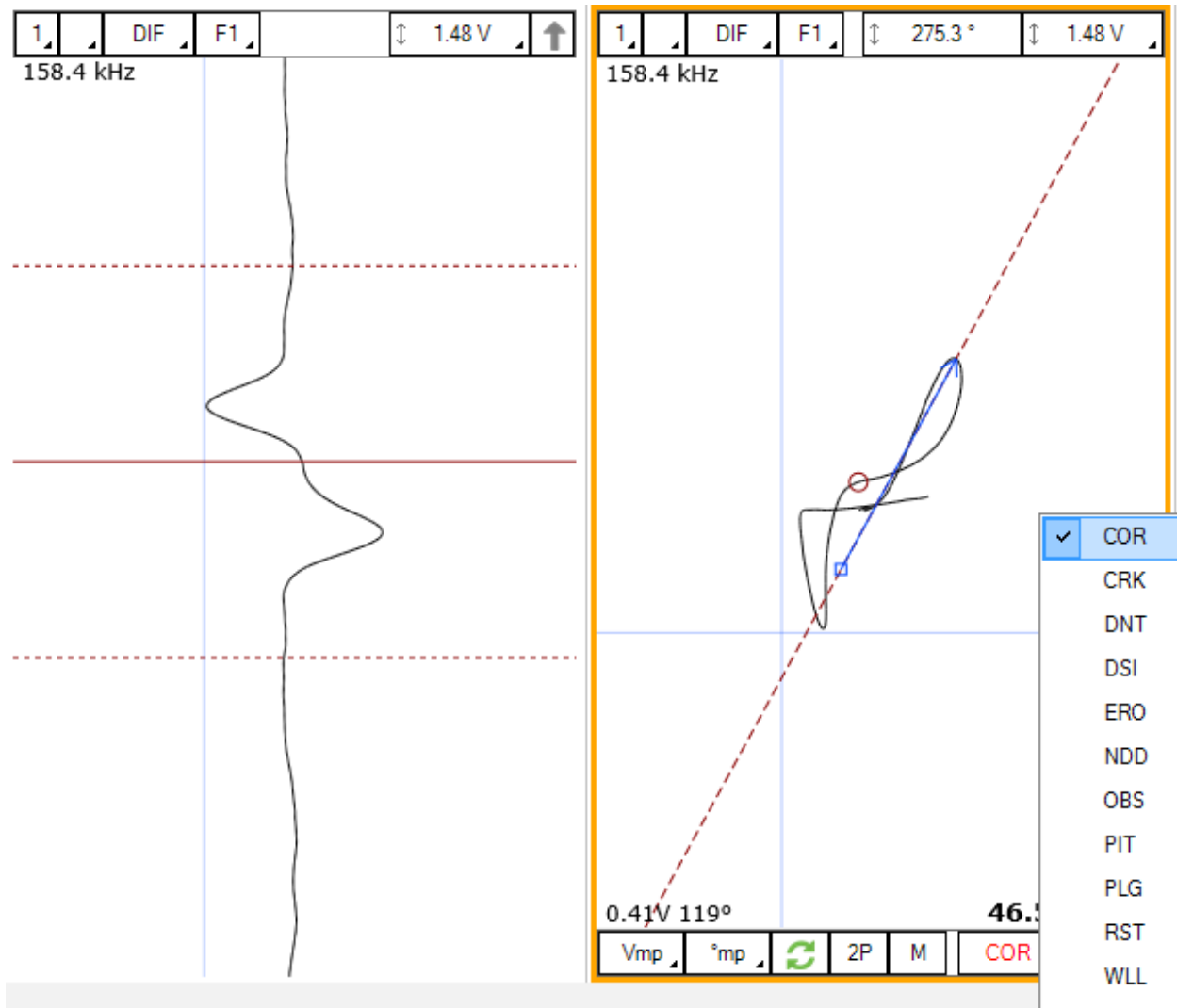

Report Entries can also be added with keyboard shortcuts. How to set up these keyboard shortcuts is explained in the SMART Setup section of this manual.

Indications can also be added to a tube to indicate, for instance, that it has no flaws or that it is plugged.

To add an indication to a tube:

1. Load the file
2. Click on the appropriate indication button available under the Analysis tab

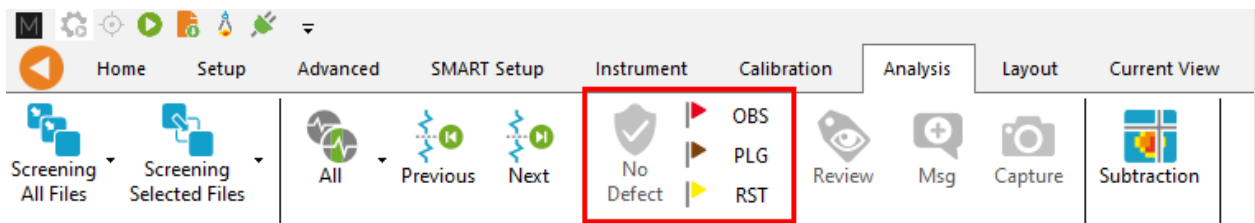

## REPORT TABLE

To access the list of indications entered:

1. Make sure that the Report option is selected under the Layout tab.

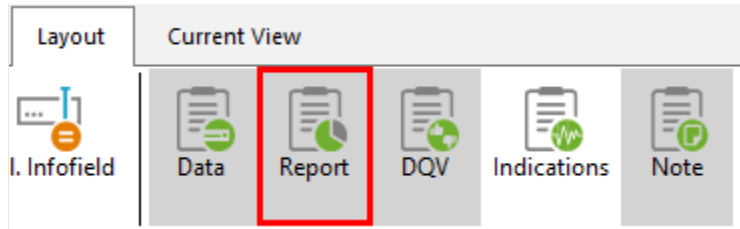

2. Click on the report ribbon at the bottom of the screen to make the list visible.

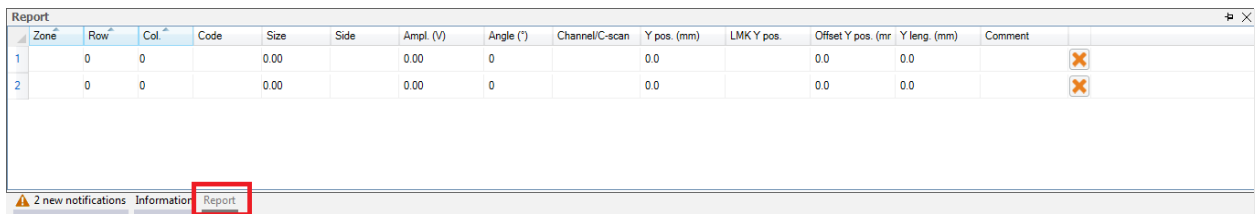

Zone	Row	Col.	Code	Size	Side	Ampl. (V)	Angle (°)	Channel/C-scan	Y pos. (mm)	LMK Y pos.	Offset Y pos. (mm)	Y leng. (mm)	Comment
1	0	0		0.00		0.00	0		0.0		0.0	0.0	
2	0	0		0.00		0.00	0		0.0		0.0	0.0	

Entries in the report can be modified by changing the value in the table. You can also delete an entry by clicking on the X next to it.

## REPORT GENERATION

Magnifi can automatically generate a full report with the report table.

To generate this report:

1. Go to the *Backstage* by clicking on the arrow at the upper left corner of the *Frontstage*.
2. Click on the *Generate Report* button under the *Report* section of the *General* tab.
3. Choose your preferences and enter the required parameters. The *# of tubes in component* is used to show the percentage of tubes in each category.

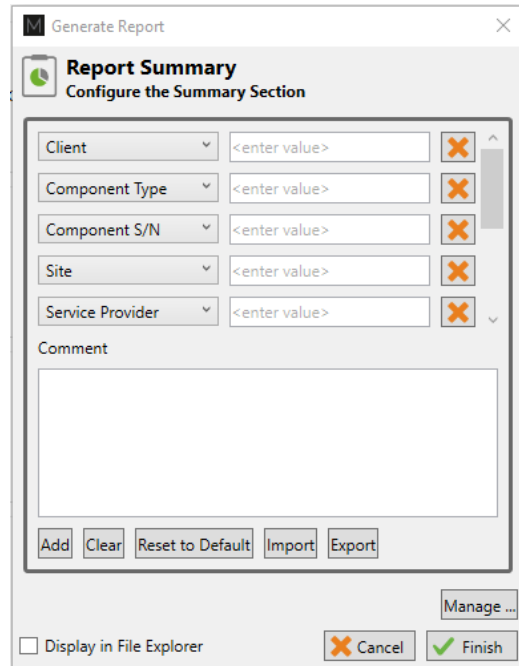
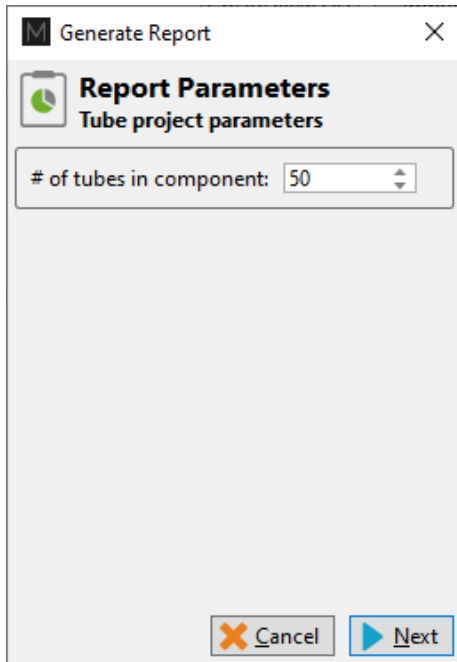

4. Click Finish to generate the report.

Once generated, the report is saved as a .html file in the current Inspection sub-directory. It can be viewed using any regular web browser.

There is a “copy” button next to each element of the report such as tables and images. When clicking on it, the element will be copied to the clipboard. It can then be pasted to another file such as an Excel or Word.

Name	Frequency (KHz)	Drive (V)	Gain (dB)	Low Pass (KHz)	High Pass (Cnt)
R_ABS-F1	160.0	2.50	46.0	400	
R_ABS-F2	80.0	2.50	46.0	400	
R_ABS-F3	40.0	2.50	46.0	400	
R_ABS-F4	20.0	2.50	46.0	400	
R_DIF-F1	160.0	2.50	46.0	400	
R_DIF-F2	80.0	2.50	46.0	400	
R_DIF-F3	40.0	2.50	46.0	400	
R_DIF-F4	20.0	2.50	46.0	400	

The Print button, bottom right corner on image above, can be used to either print a paper copy of the whole report or to save it as a .pdf document. The PDF generator available with the current web browser will be used.

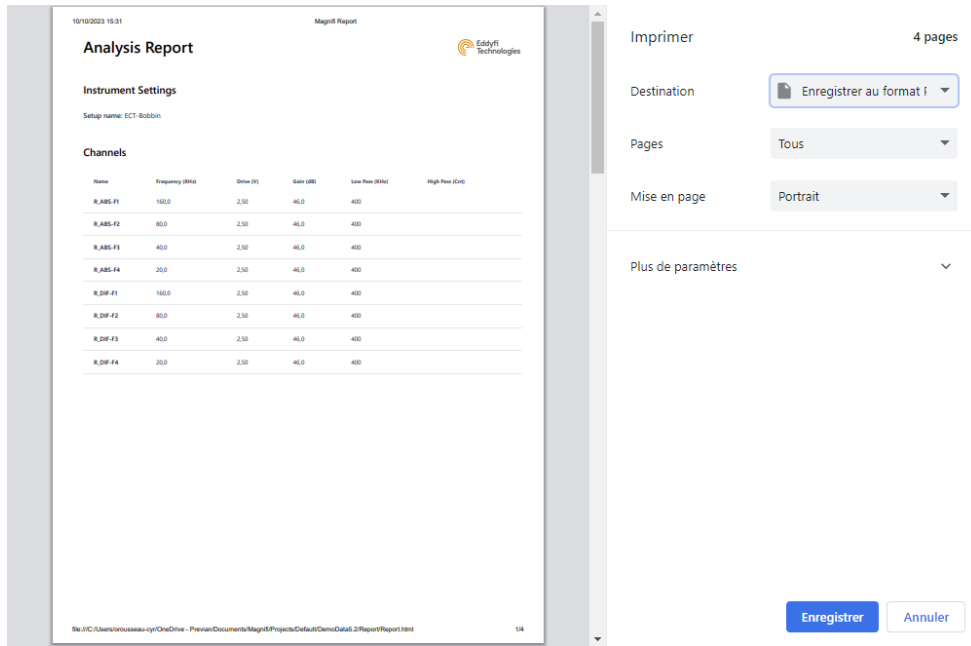

The report logo can be modified by clicking on the *Select Company Logo* that can be found under the *System* tab of the *Backstage*.

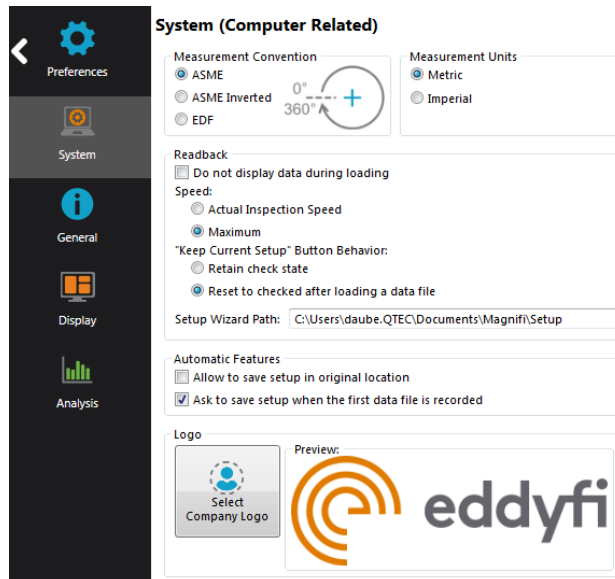

The report table file in the *Inspection* folder can also be imported into other reporting software such as *TubePro*.

# DefHi™ Application Guide



## ECA DefHi® Probes



## INTRODUCTION

This document presents how to set up and calibrate the DefHi® probe with Magnifi 5 on an Ectane test instrument using the Setup Wizard. Equipment

The DefHi® probes use a 160-pin connector that can be connected to an Ectane with the “E64” or “E128” option (depending on the probe model).

As this probe needs to be near the tube surface, a wide range of probe diameters are offered (see the tubing probe catalog for more details). A wide range of frequencies is also available to allow inspections of tubes of different thickness and material.

From the following tables, the best probe for your application can be selected.

Table 4 – Probe diameter selection table

		TUBE WALL THICKNESS (BWG, mm, in)															
		BWG	10	11	12	13	14	15	16	17	18	19	20	21	22	23	24
		mm	3.40	3.05	2.77	2.41	2.11	1.83	1.65	1.47	1.24	1.07	0.89	0.81	0.71	0.65	0.56
		in	0.135	0.120	0.109	0.095	0.083	0.072	0.065	0.058	0.049	0.042	0.035	0.032	0.028	0.025	0.022
TUBE OUTSIDE DIAMETER	12.70 mm	0.500 in	-	-	-	-	-	-	-	-	096	096	102	102	106	106	106
	15.87 mm	0.625 in	-	-	096	102	106	114	118	118	126	126	132	132	136	136	136
	19.05 mm	0.750 in	114	118	126	136	140	148	148	148	156	156	162	162	166	166	170
	22.22 mm	0.875 in	148	148	156	166	170	178	178	186	186	192	192	196	196	196	200
	25.40 mm	1.000 in	178	186	186	196	200	208	208	216	220	220	226	226	226	230	230

Table 5 – Probe frequency range selection table

		TUBE WALL THICKNESS (BWG, mm, in)															
		BWG	10	11	12	13	14	15	16	17	18	19	20	21	22	23	24
		mm	3.40	3.05	2.77	2.41	2.11	1.83	1.65	1.47	1.24	1.07	0.89	0.81	0.71	0.65	0.56
		in	0.135	0.120	0.109	0.095	0.083	0.072	0.065	0.058	0.049	0.042	0.035	0.032	0.028	0.025	0.022
MATERIAL	Brass (admiralty)	-	-	-	-	-	HW	HW	HW	HW	HW	LF	LF	LF	LF	LF	
	Brass (70/30)	-	-	-	-	-	HW	HW	HW	HW	HW	LF	LF	LF	LF	LF	
	Brass (85/15)	-	-	-	-	-	-	HW	HW	HW	HW	HW	LF	LF	LF	LF	
	Brass (95/5)	-	-	-	-	-	-	-	-	HW	HW	HW	HW	HW	LF	LF	
	Copper	-	-	-	-	-	-	-	-	-	-	HW	HW	HW	HW	HW	
	Copper-nickel (70/30)	HW	HW	HW	HW	LF	LF	LF	LF	LF	LF	MF	MF	MF	MF	MF	HF
	Copper-nickel (90/10)	-	HW	HW	HW	HW	HW	LF	LF	LF	LF	LF	MF	MF	MF	MF	MF
	Copper-nickel (95/5)	-	-	-	HW	HW	HW	HW	HW	LF	LF	LF	LF	LF	LF	MF	MF
	Inconel 600	LF	LF	LF	LF	LF	MF	MF	MF	MF	MF	MF	HF	HF	HF	HF	HF
	Stainless steel 304/316	HW	LF	LF	LF	LF	LF	MF	MF	MF	MF	MF	HF	HF	HF	HF	HF
Titanium 99%	HW	HW	HW	LF	LF	LF	LF	LF	LF	MF	MF	MF	MF	HF	HF	HF	
Zirconium	HW	HW	HW	LF	LF	LF	LF	LF	LF	MF	MF	MF	MF	MF	MF	HF	HF

Table 6 - Frequency range

FREQ. (kHz)
HW: 4–60 kHz LF: 20–200 kHz MF: 50–500 kHz* HF: 100–1200 kHz**

\* Maximum MF is reduced to 400 kHz with 15 m cable.  
 \*\* Maximum HF is reduced to 1 MHz with 15 m cable.

Table 7 – Total number of array channels

PROBE DIAM.	FREQ.		HW		LF		MF		PROBE DIAM.	FREQ.		HF	
	CONFIG.		BC	BCA	BC	BCA	BC	BCA		CONFIG.	BC	BCA	
	096–106		–	–	12	36	18	54		096–106		–	–
	114–140		12	36	18	54	18	54		132–136		18	54
	148–178		12	36	24	72	24	72		162–170		24	72
	186–196		18	54	24	72	24	72		196–200		30	90
	200–230		18	54	30	90	30	90		226–230		36	108

Defhi® probes are available with one row or two rows pancake coils. The model with one row (ERBC) will allow the detection of circumferential cracks. The model with two rows (ERBCA) will allow the detection of both axial and circumferential cracks with the array part of the probe.

Table 4 indicates the number of array channels for each standard probe. The total number of channels for a DefHi® probe equals the number of array channels plus two (one for the absolute and one the differential bobbin channels). Therefore, if the number of array channels is 63 or over, it means that an Ectane with the “E64” option won’t have enough channel for this probe and that an Ectane with the “E128” option will be required to use this probe.

The DefHi® calibration tube used in this document includes the following flaws:

- Internal groove, 10% of wall loss
- External groove, 20% of wall loss
- Hole, 100% of wall loss
- OD Flat Bottom Hole (FBH) at 40%, 60% and 80% depth
- OD 4 x FBH 20% depth

Other combinations of flaws can be used to calibrate the probe and to build sizing curves.

## PROJECT AND INSPECTION FILES

---

In this section, we will create a folder structure that will manage the saving location of your setup, data and report. This management is operated through the creation of a *Project*.

Magnifi suggests two levels of files. The first level is the *Project*. It is meant to include different inspections that are related in some way. For instance, it can include all the inspections done at a refinery shutdown and be named *Refinery\_Shutdown\_May\_2018*. The second level of the file is the *Inspection* folder. Inspection folders are saved in the project file. An inspection folder can include the data specific to the inspection of a tube bundle with a specific technology and could be named *SS316\_075x0.065\_ECT*, for instance. This inspection folder groups the setup, the tube list, the data files and the Magnifi report.

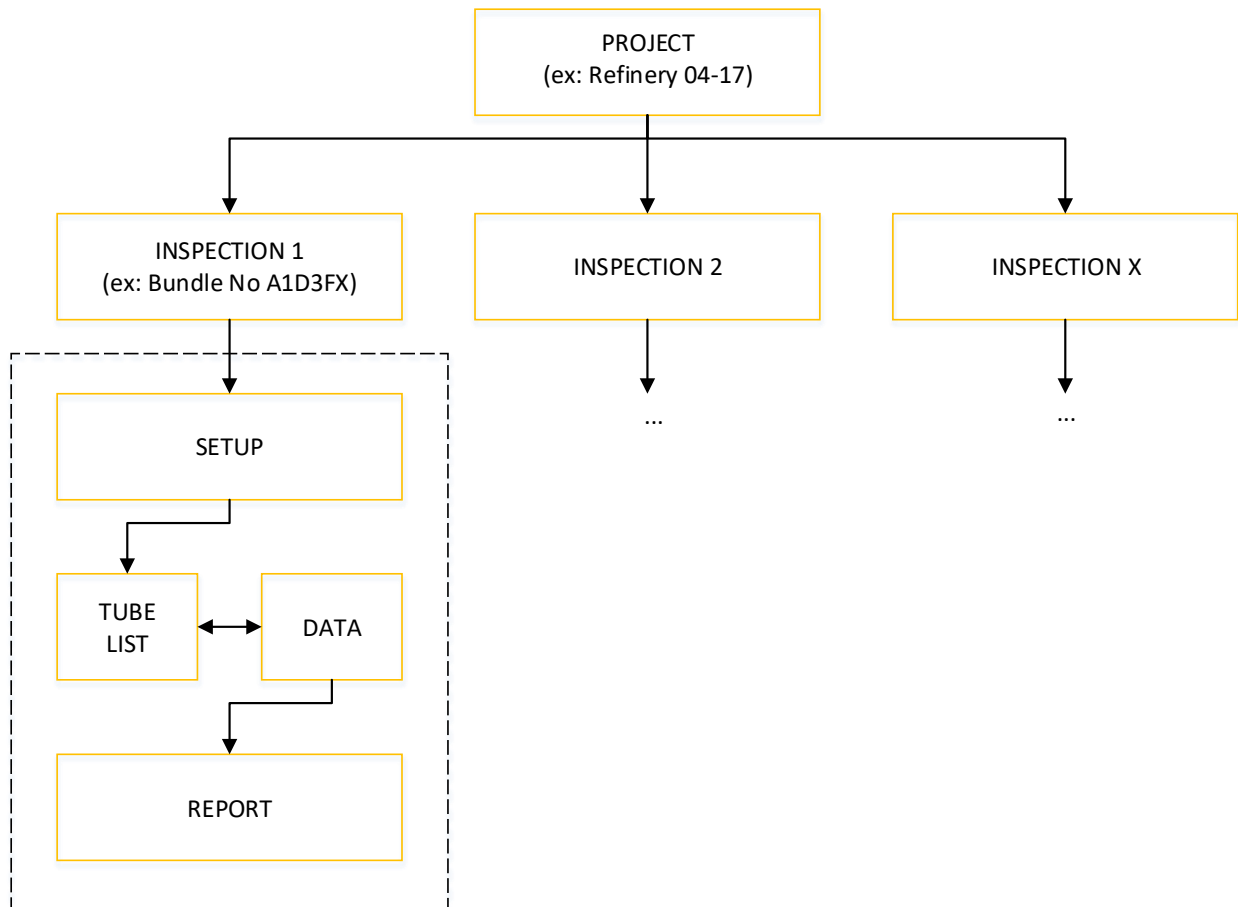

When you open Magnifi, the first page displayed is called the *Backstage*.

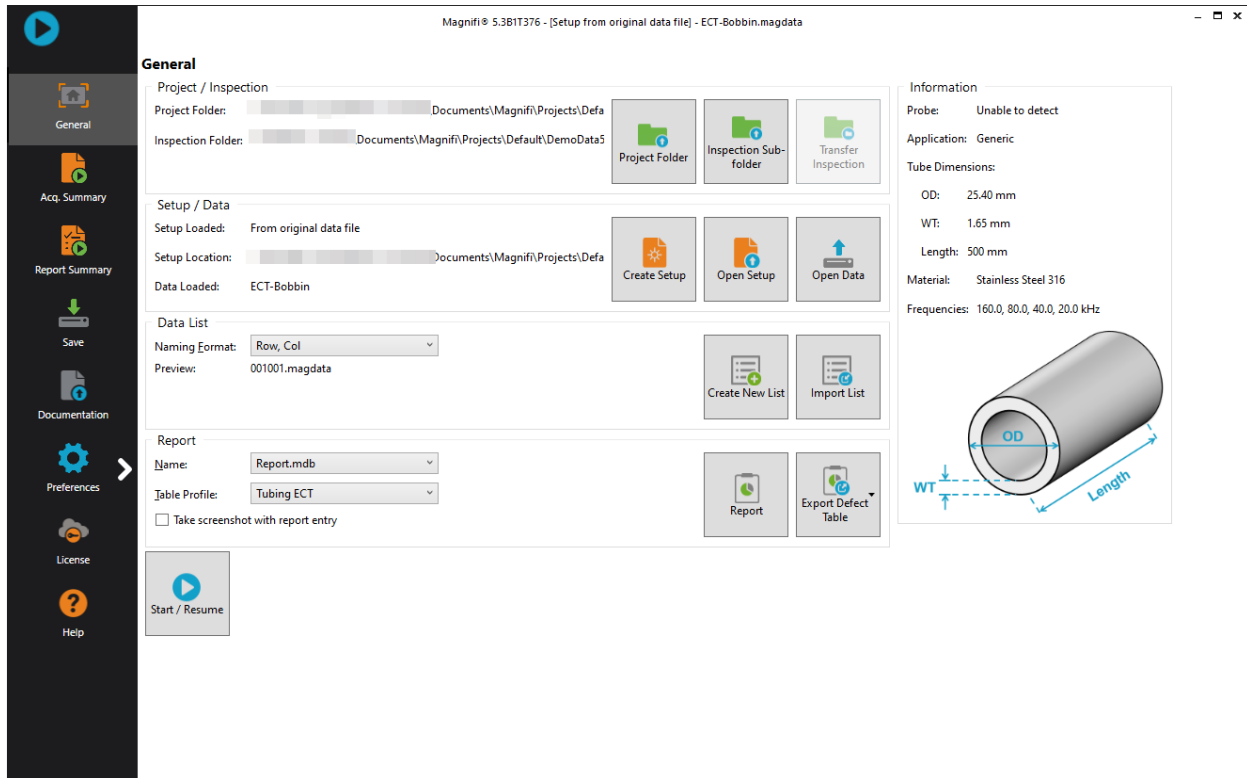

To create or open a project, click on *Open/Add Project* in the backstage. You can select an existing project/folder or you can create a new folder.

1. Create a folder by right-clicking on the location where you want to add your project file. Select *New, Folder* and enter the chosen name. You can then select the newly created folder and click on *Select Folder*.

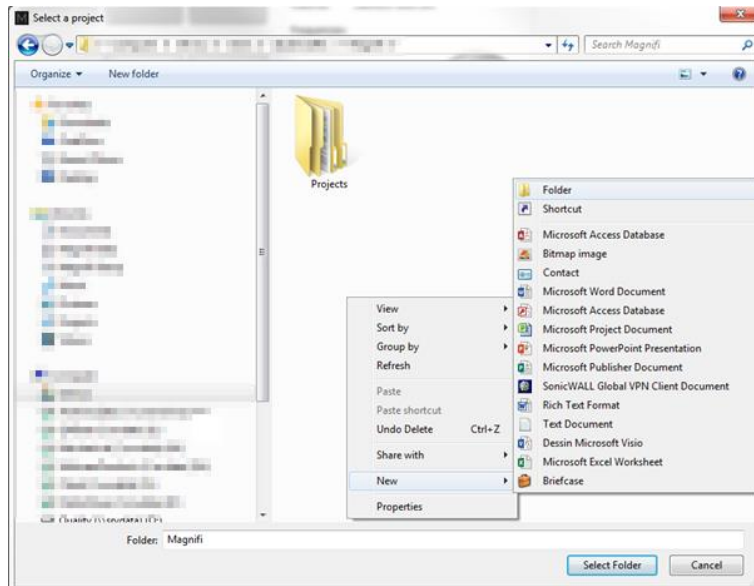

2. Click on *Add/Open Inspection* in the backstage, then click on *Add* and enter the name of your inspection.

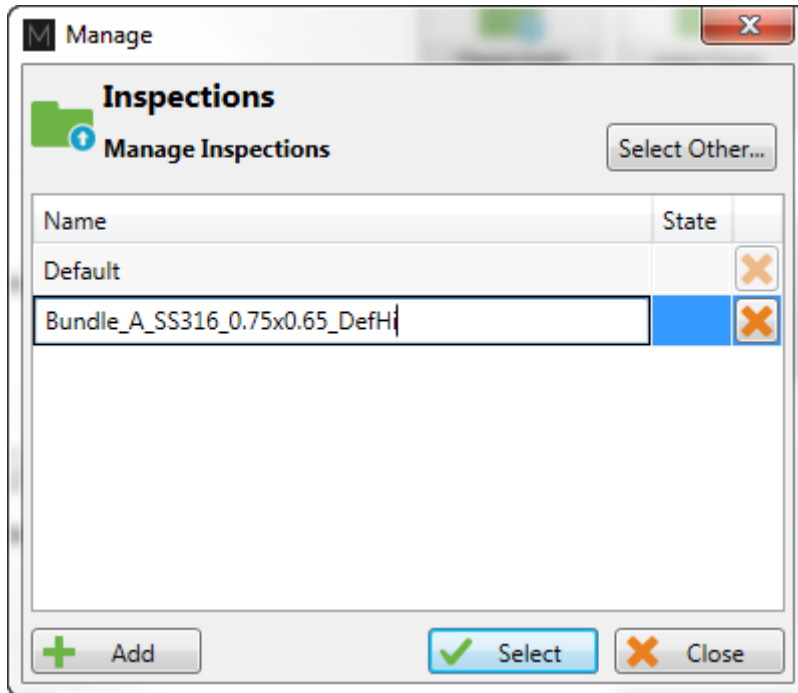

3. Click *Select*. This will define the position where the setup(s) and data will be saved.

## SETUP WIZARD

---

In this section, we will show how to create a setup using the *Setup Wizard* in Magnifi.

Before going further, you can change the measurement unit. To do so, click on *Preferences*. In the *System* tab, you can change the measurement units from metric to imperial and vice versa. For the metric units, you can choose to use meters, centimeters, or millimeters in the *General* tab. The default measurement for imperial units is inches. When finished, click on *Preferences* again to go back to the *General* window.

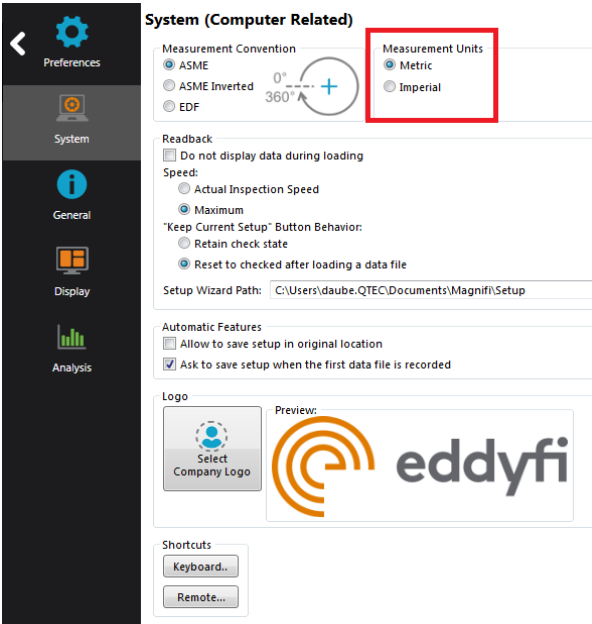

To create a new setup, it's strongly suggested to use the *Setup Wizard* process. Click on *Create Setup* to start the *Setup Wizard*.

## COMPONENT DEFINITION

The first page shown by the *Setup Wizard* is the *Component Definition*.

Click on the *Material* field to open the drop-down menu. Select the material of the tube to be inspected. If the material is not in the list, you can click on *Manage...* to open the *List of Available Material* window.

**New Setup Wizard**

### Component Definition

Configure the geometry and material of the component to inspect

Geometry:  Surface  Tube from ID

Application:  Generic  Air Conditioner

Material: Stainless Steel 316

Resistivity: 74  $\mu\Omega\cdot\text{cm}$   
Permeability: 1  $\mu$   
Velocity: 5660.000 m/s

Wall thickness: 2.11 mm

6 14 24 BWG

Outside diameter: 25.40 mm  
Length: 6000 mm

Note about selected material:  
Application: Austenitic alloy-steel boiler, superheater, and heat-exchanger tubes.  
Composition: ~17% Cr, ~12% Ni, 2% Mo, Fe remaining  
UNS: S31600  
ASTM: A213 TP316, A249 TP316, A688 TP316

To add a new material to the list, click on *Add*. A new line will appear in the list. Give the material a relevant name and set the material resistivity and permeability to its theoretical value. The ultrasound velocity is used to set IRIS parameters only, and doesn't need to be set if an IRIS inspection is not performed on this material.

It's possible to add a note about the material to specify information such as its application or composition. When you are done, click *OK*.



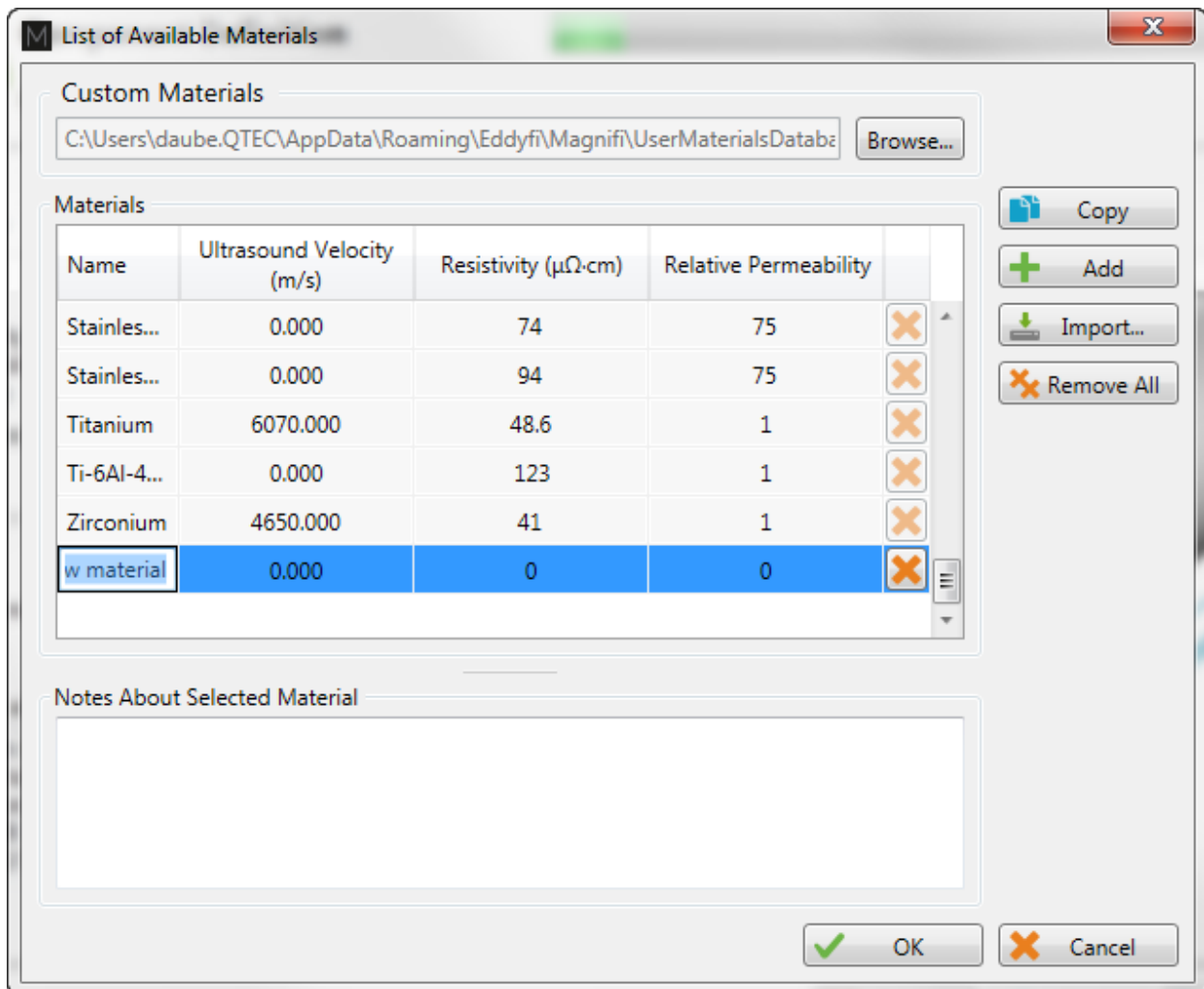

You will be back to the *Component Definition* window. If you added a new material, it will now be available in the material list.

Adjust the tube wall thickness by entering the value in the *Wall thickness* field or by moving the slider. Enter the tube's outer diameter and length.

These tube properties will help Magnify to suggest the optimal scan parameters.

Click *Next* when everything is set correctly.

## PROBE SELECTION

In the *Probe Selection* window, select the probe you will be using for your inspection.

You can filter the probe list by choosing an inspection technique from the *Technique* drop-down menu. More precise filtering can be done by using the *Model* drop-down menu. You can then select your probe by its catalog number and then click *Next*.

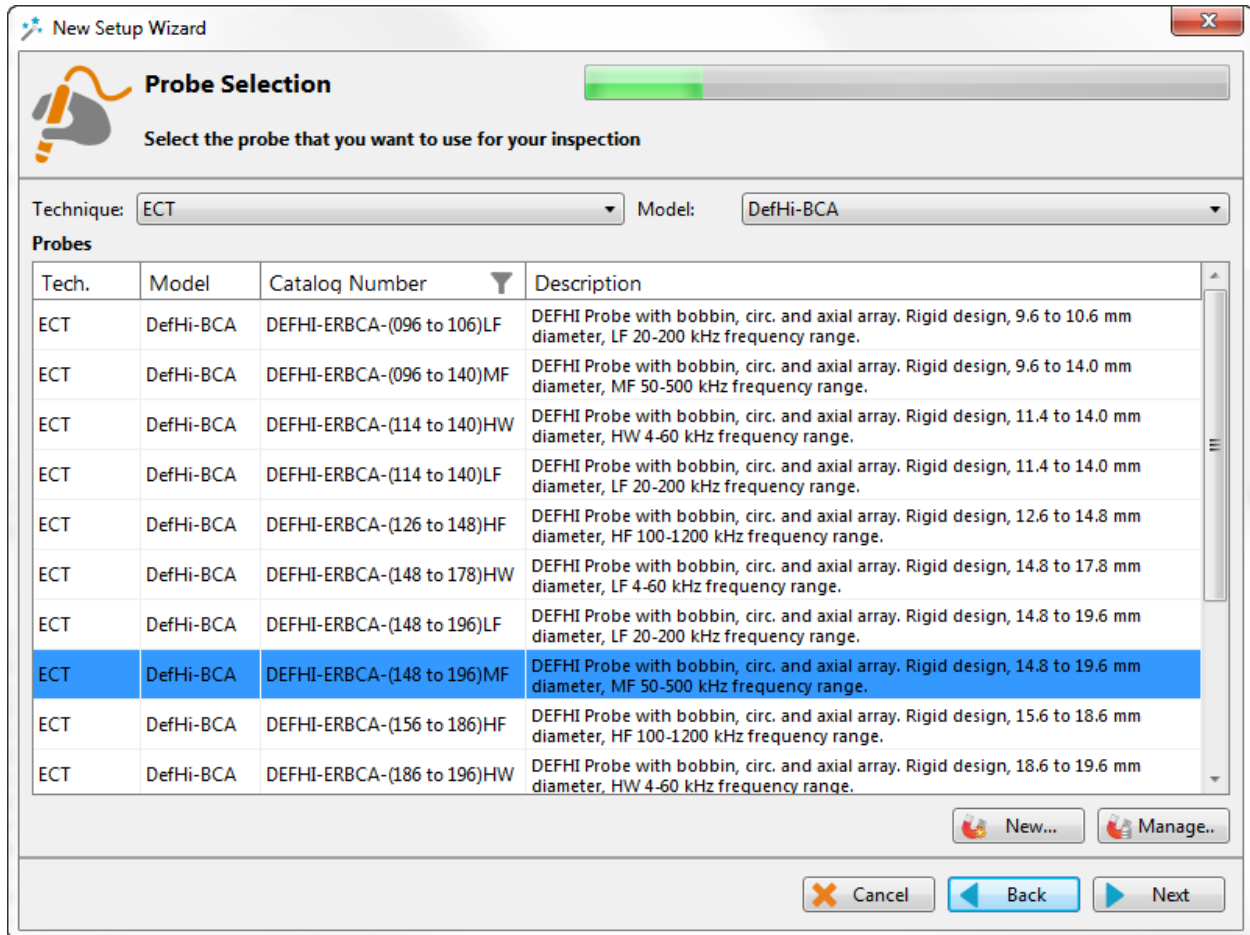

**New Setup Wizard**

**Probe Selection**

Select the probe that you want to use for your inspection

Technique: **ECT** Model: **DefHi-BCA**

**Probes**

Tech.	Model	Catalog Number	Description
ECT	DefHi-BCA	DEFHI-ERBCA-(096 to 106)LF	DEFHI Probe with bobbin, circ. and axial array. Rigid design, 9.6 to 10.6 mm diameter, LF 20-200 kHz frequency range.
ECT	DefHi-BCA	DEFHI-ERBCA-(096 to 140)MF	DEFHI Probe with bobbin, circ. and axial array. Rigid design, 9.6 to 14.0 mm diameter, MF 50-500 kHz frequency range.
ECT	DefHi-BCA	DEFHI-ERBCA-(114 to 140)HW	DEFHI Probe with bobbin, circ. and axial array. Rigid design, 11.4 to 14.0 mm diameter, HW 4-60 kHz frequency range.
ECT	DefHi-BCA	DEFHI-ERBCA-(114 to 140)LF	DEFHI Probe with bobbin, circ. and axial array. Rigid design, 11.4 to 14.0 mm diameter, LF 20-200 kHz frequency range.
ECT	DefHi-BCA	DEFHI-ERBCA-(126 to 148)HF	DEFHI Probe with bobbin, circ. and axial array. Rigid design, 12.6 to 14.8 mm diameter, HF 100-1200 kHz frequency range.
ECT	DefHi-BCA	DEFHI-ERBCA-(148 to 178)HW	DEFHI Probe with bobbin, circ. and axial array. Rigid design, 14.8 to 17.8 mm diameter, LF 4-60 kHz frequency range.
ECT	DefHi-BCA	DEFHI-ERBCA-(148 to 196)LF	DEFHI Probe with bobbin, circ. and axial array. Rigid design, 14.8 to 19.6 mm diameter, LF 20-200 kHz frequency range.
ECT	DefHi-BCA	DEFHI-ERBCA-(148 to 196)MF	DEFHI Probe with bobbin, circ. and axial array. Rigid design, 14.8 to 19.6 mm diameter, MF 50-500 kHz frequency range.
ECT	DefHi-BCA	DEFHI-ERBCA-(156 to 186)HF	DEFHI Probe with bobbin, circ. and axial array. Rigid design, 15.6 to 18.6 mm diameter, HF 100-1200 kHz frequency range.
ECT	DefHi-BCA	DEFHI-ERBCA-(186 to 196)HW	DEFHI Probe with bobbin, circ. and axial array. Rigid design, 18.6 to 19.6 mm diameter, HW 4-60 kHz frequency range.

New... Manage..

Cancel Back Next

## SCAN DEFINITION

The *Scan Definition* window is used to configure the axial position measurement method, the acquisition rate and the typical probe speed.

The screenshot shows a software window titled "New Setup Wizard" with a sub-window titled "Scan Definition". The window contains a progress bar and the instruction "Configure the type of scan you will be performing with your probe". The settings are as follows:

Scan:	Single Pass
Main Scan Axis:	Y Axis
Position from:	Clock
Acquisition rate:	1500 Hz
Typical probe speed:	300.0 mm/s

At the bottom of the window, there are three buttons: "Cancel", "Back", and "Next".

The position along the tube can be defined by using either the internal clock of the system, or by using an axial encoder. If you use the internal clock, the default position will be given assuming that the probe is always pulled at the typical probe speed. If the typical probe speed is set to 300mm/s, and the time since the acquisition began was 2 seconds, then the system will indicate a position of 600mm. Using an encoder will give you the exact position of the probe. Note that the position can also be obtained by using the landmark tool, but this feature will be shown later.

The acquisition rate is the number of acquisition points taken per second. By default, the acquisition rate is set to 1500 Hz for DefHi, but depending on the drive frequency used to inspect, the actual acquisition rate may differ. The system will automatically readjust this value if needed.

The axial resolution will depend on the combination of the acquisition rate and pulling speed. For an acquisition rate of 2000 Hz, the pulling speed needs to be less than 1m/s to have at least 2 points per millimeter. If you do not use a pusher-puller device such as Probot, the pulling speed won't be constant. Therefore, it is recommended to target a lower pulling speed to be able to reach your axial resolution

target. The typical probe speed should be set as close as possible to the real value. This will help the algorithm that automatically detects landmarks (this will be explained in the Landmarks section). The recommended pulling speed for DefHi® is approximately 300mm/s (12in/s).

If you select to measure the position from Encoder, different fields will appear, and a second *Scan Definition* page will become available.

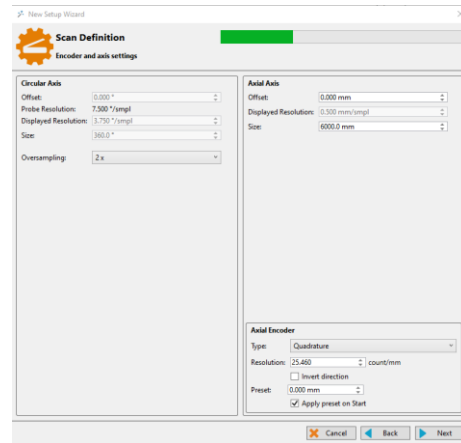
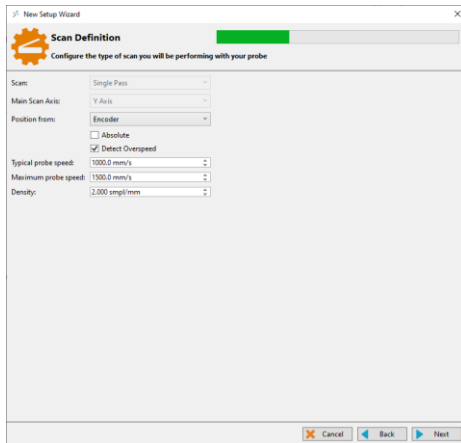

On the first page, the *Typical probe speed*, *Maximum probe speed* and the *Density* will have to be entered. The *Maximum probe speed* is the maximum acceptable speed for your probe and the *Density* is the number of acquired points per millimeter (axial resolution). These values will be used to set the acquisition rate and to optimize the acquisition processes used by the Ectane. Note that if your probe is pulled at a speed exceeding the *Maximum probe speed*, there will be gaps in the data.

The second page includes the type of encoder and its resolution. A preset can also be specified if your acquisition doesn't start at 0 mm.

Click *Next* when you're finished.

## DATA DEFINITION

The *Data Definition* window is used to set the hardware gain, frequency and drive voltage for the *Absolute* and *Differential* channels. It is important to set these parameters correctly before acquiring the data since they are driven by the instrument and cannot be modified during the analysis.

**Data Definition**

Select the C-scans you will be using and the necessary frequencies

Connector: 160 pins  
Gain: 58 dB

C-scans		Required frequencies			
Name	Prefix	Prefix	Val (kHz)	Ampl (V)	Phase (°)
<input checked="" type="checkbox"/> Axial	A	F1	99.2	2.50	0.0
<input checked="" type="checkbox"/> Circumferential	C	F2	49.6	2.50	0.0

Suggest    + Add

Cancel    Back    Next

Pages of this section are used to set the parameters of the array part of the probe (C-Scan) and others are used for the bobbin part of the probe (channels).

By default, Magnifi suggests two frequencies for the array part of the probe and four frequencies the bobbin part. These frequencies are calculated with the parameters previously entered:

Prefix	Frequency	Channels
F1	2 x F90	Array & bobbin
F2	F90	Array & bobbin
F3	F90/2	bobbin
F4	F90/8	bobbin

The frequency and drive voltage can be changed by replacing their values in the *Required frequencies* table. Up to 4 frequencies can be set at the same time, and the sum of their amplitude cannot exceed 10V.

Make sure that the frequencies are within the probe limits that you can find in Table 3. If one of the suggested frequencies is not within the recommended probe frequency range, you can either remove it by clicking on the X or change it within the recommended range.

Click on *Next* when the desired parameters are entered.

## DATA PROCESSING

The next windows are used to build mixed channels. Mixes are processed channels that are mainly used to detect indication close to support plates. They are built with two frequencies of the same channel type to attenuate the effect of the support plate and to be able to size an indication at this location more accurately.

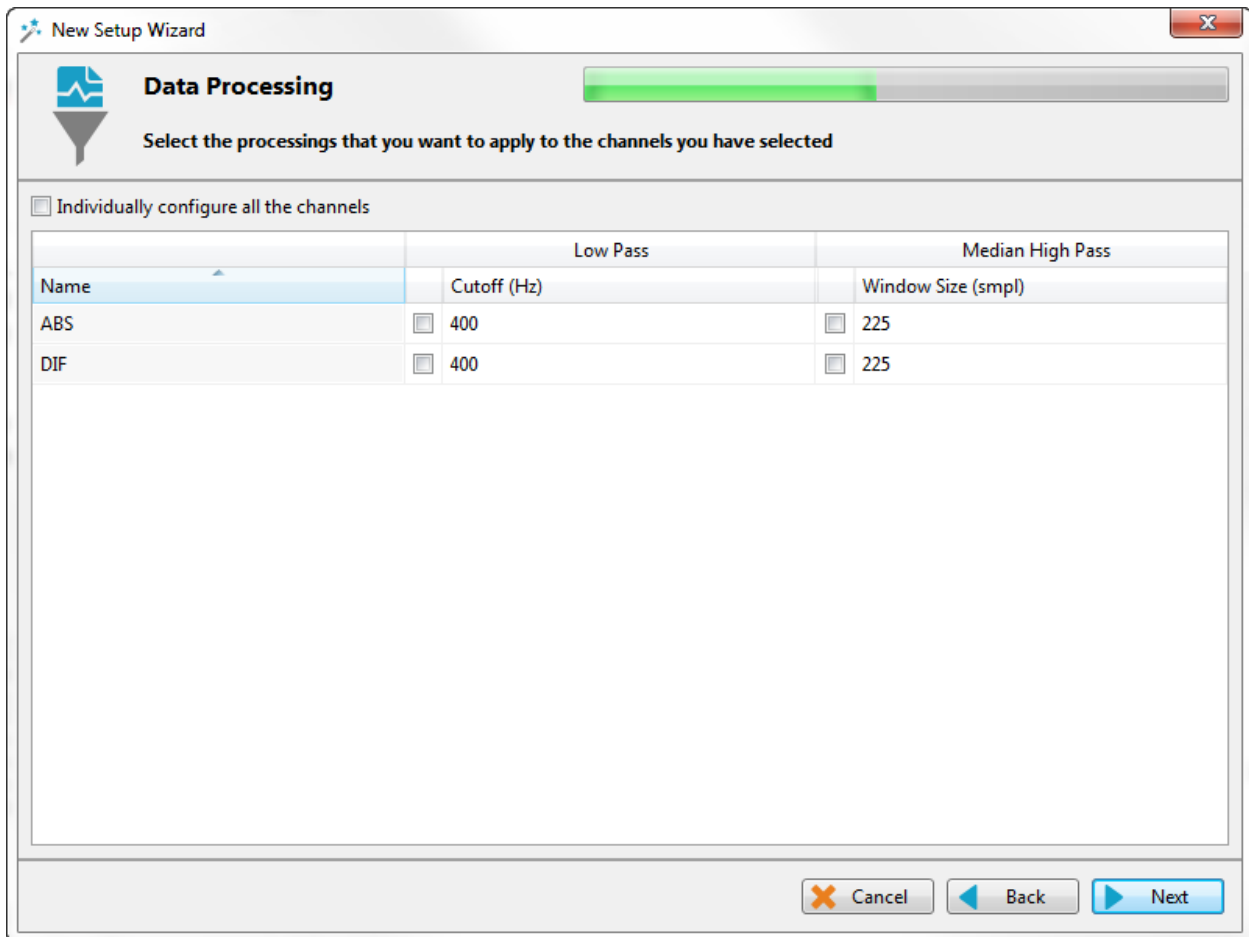

If you do not wish to use mixed channels, click on Next.

To add a mixed channel, click on the *Add* button. A new line will appear. Choose from which input you want to use the mixed channel. Note that *Input Channel 2* must have a lower frequency than *Input Channel 1*. Mixed channels can be built for C-Scans, absolute and differential channels.

You can rename the mixed channel output by modifying the *Output Mixed Channel* field.

The mixed reference signal (usually a support plate signal) will be used to calibrate the mix channel. The system will apply processes to the chosen input channels and will subtract them to attenuate the reference signal.

Click on Next to configure the signal processing to apply to the channels.

You can choose to configure every frequency individually with the *Individually configure all the channels/C-scans* check box or you can apply the same filters to every channel/C-scans.

Note that the signal processing is done after the data acquisition. An inappropriate parameter choice can be changed without any problem during data analysis, while a wrong parameter choice for the data acquisition can mislead the analysis. It is possible to change the filter parameters after the acquisition, so it is always possible to fine tune the filter parameters during the analysis.

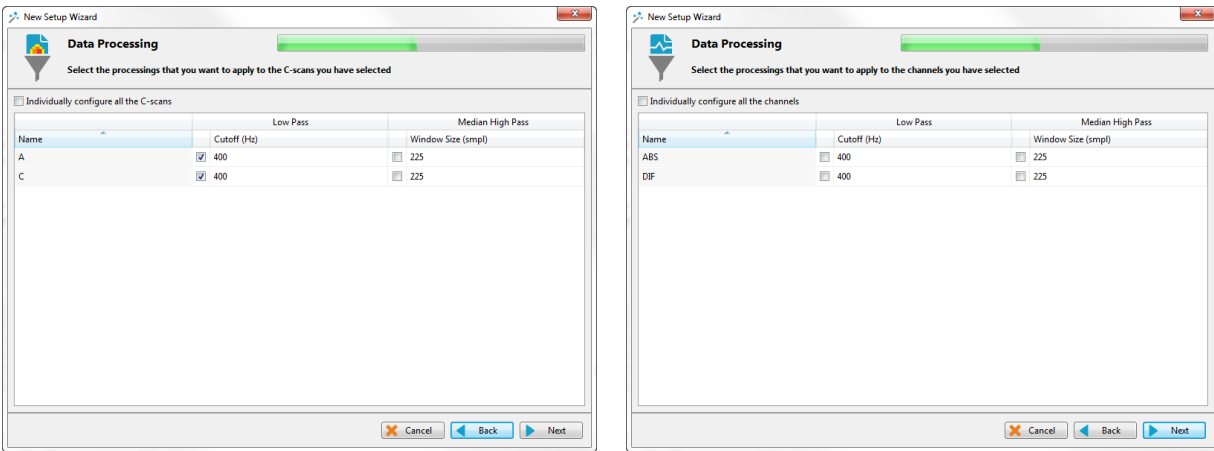

The low pass filter eliminates part of the signal that is above a certain frequency. As an example, it is useful when your defect signal has a lower frequency content than the background noise. In this case, using a filter will remove part of the noise without removing the defect's signal. This may help with data analysis. However, a cutoff frequency that is too high won't remove much noise, and a cutoff frequency that is too low will filter out the defect's signal.

The median high pass filter is used to filter out low frequency noise such as lift-off variations of the probe within the tube, changes in material, geometry or thickness. As a rule-of-thumb, the width of the high-pass median filter should be set to at least three times the axial length of the longest flaw that may be encountered. Data should be examined in both its filtered and unfiltered states. It is important to keep in mind that the median high-pass filters can distort phase. More information about median filter for NDT analysis can be found on Eddyfi's blog.

## CALIBRATION POINTS

The *Calibration Points* page is used to define the points in your calibration tube. These indications will later be used to calibrate your probe and to build sizing curves.

The calibration point units of measurement can be set in percentage or in depth (millimeters or inches).

You can add calibration points by clicking on the *Add* button. Specify the calibration point name, side and size. The side and size of the flaw will be used to position the calibration point in the sizing curve(s).

Calibration points can also be imported with the *Import* button.

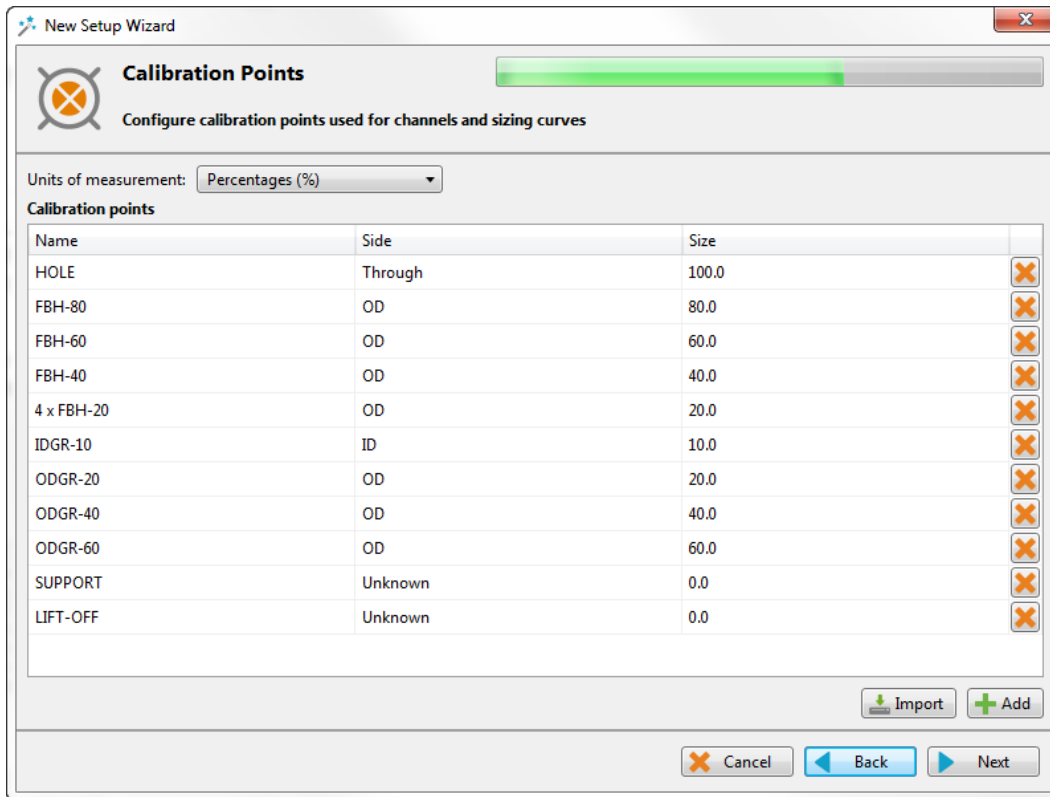

Click *Next* when you have set the required calibration points for your calibration(s) and sizing curve(s).

## CALIBRATION

The *Calibration* pages are used to define reference signal(s) that will be used to set the amplitude(s) and phase(s) of each channel using the selected measurement method. There are two calibration pages: one for the array (C-Scans) and one for the bobbin (channels).

By default, the calibration is performed on the Hole signal by adjusting it to 1V and 40° on the C-scans, the absolute and the differential channel. However, the calibration can be done differently on each channel type. It can also be done individually for each frequency by selecting the *Individually configure all the channels* option. Different reference signals can be set to calibrate the phase and the amplitude independently.



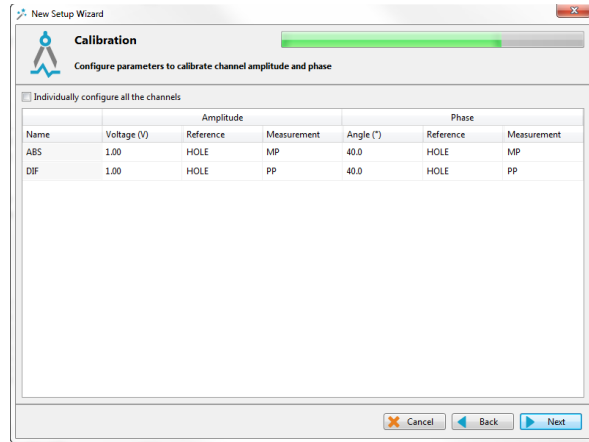
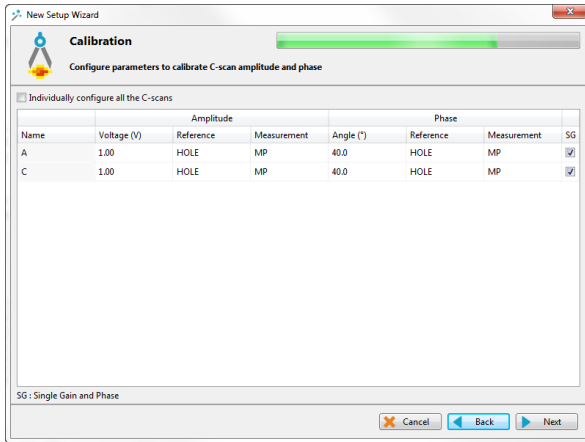

When you select the reference signal, the system will use the selected measurement method to apply a rotation and a gain. Here is a short description of the available options:

1. **Absolute (A):**  
Uses a straight line from the Lissajous origin to the main cursor position to measure amplitude.
2. **Absolute Horizontal (AH):**  
Uses only the horizontal component, from the Lissajous origin to the main cursor position to measure amplitude.
3. **Absolute Vertical (AV):**  
Uses only the vertical component, from the Lissajous origin to the main cursor position to measure amplitude.
4. **Absolute Peak (AP):**  
Uses a straight line, from the Lissajous origin to the peak value of the data selection, to measure amplitude.
5. **Absolute Peak Horizontal (APH):**  
Uses only the horizontal component, from the Lissajous origin to the peak value of the data selection, to measure amplitude.
6. **Absolute Peak Vertical (APV):**  
Uses only the vertical component, from the Lissajous origin to the peak value of the data selection, to measure amplitude.
7. **Average Peak (MP):**  
Takes the distances from points at the extremity of the cursor to the peak of the data selection to build an average vector. Only used and recommended for absolute signals.
8. **Average Peak Horizontal (MPH):**  
Uses the horizontal component of the distances from points at the extremity of the cursor to the peak of the data selection to make an average vector. Used for absolute signals.

**9. Average Peak Vertical (MPV):**

Uses the vertical component of the distances from points at the extremity of the cursor to the peak of the data selection to make an average vector. Used for absolute signals.

**10. Peak to peak (PP):**

Uses the combination of the vertical and horizontal component to measure the maximum amplitude.

**11. Horizontal (PPH):**

Uses only the horizontal component to measure the amplitude.

**12. Vertical (PPV):**

Uses only the vertical component to measure the amplitude.

**13. Peak to peak First Transition (PPF):**

Uses the combination of the vertical and horizontal component of the first transition of the signal to measure maximum amplitude. The first signal transition is from the base of an indication to its peak.

Click on *Next* when the parameters in the table are set according to your requirements.

## SIZING CURVES

The first page of this section is the definition of your sizing curves. A curve will be built for each line in this table.

ID	Name	Measure From	Source	Measurement	
	F1A	C-scan Y	F1A	Phase	X
	F1C	C-scan Y	F1C	Phase	X
	F2A	C-scan Y	F2A	Phase	X
	F2C	C-scan Y	F2C	Phase	X
	F1ABS	Channel	F1ABS	Phase	X
	F1DIF	Channel	F1DIF	Phase	X
	F2ABS	Channel	F2ABS	Phase	X
	F2DIF	Channel	F2DIF	Phase	X

The sizing curve will allow you to estimate the size of a defect based on the calibration points signals (amplitude or phase) obtained with your calibration standard. Magnifi will give you the interpolated flaw size based on the built sizing curves.

Sizing curve names are customizable. The channel source and measurement type can also be changed. You can add sizing curves by clicking on the *Add* button.

Click *Next* when you are done.

For every sizing curve created in the last window, a window will appear to configure the curve properties. The name of the curve will be shown in the upper left corner of the page (F1A in the example below).

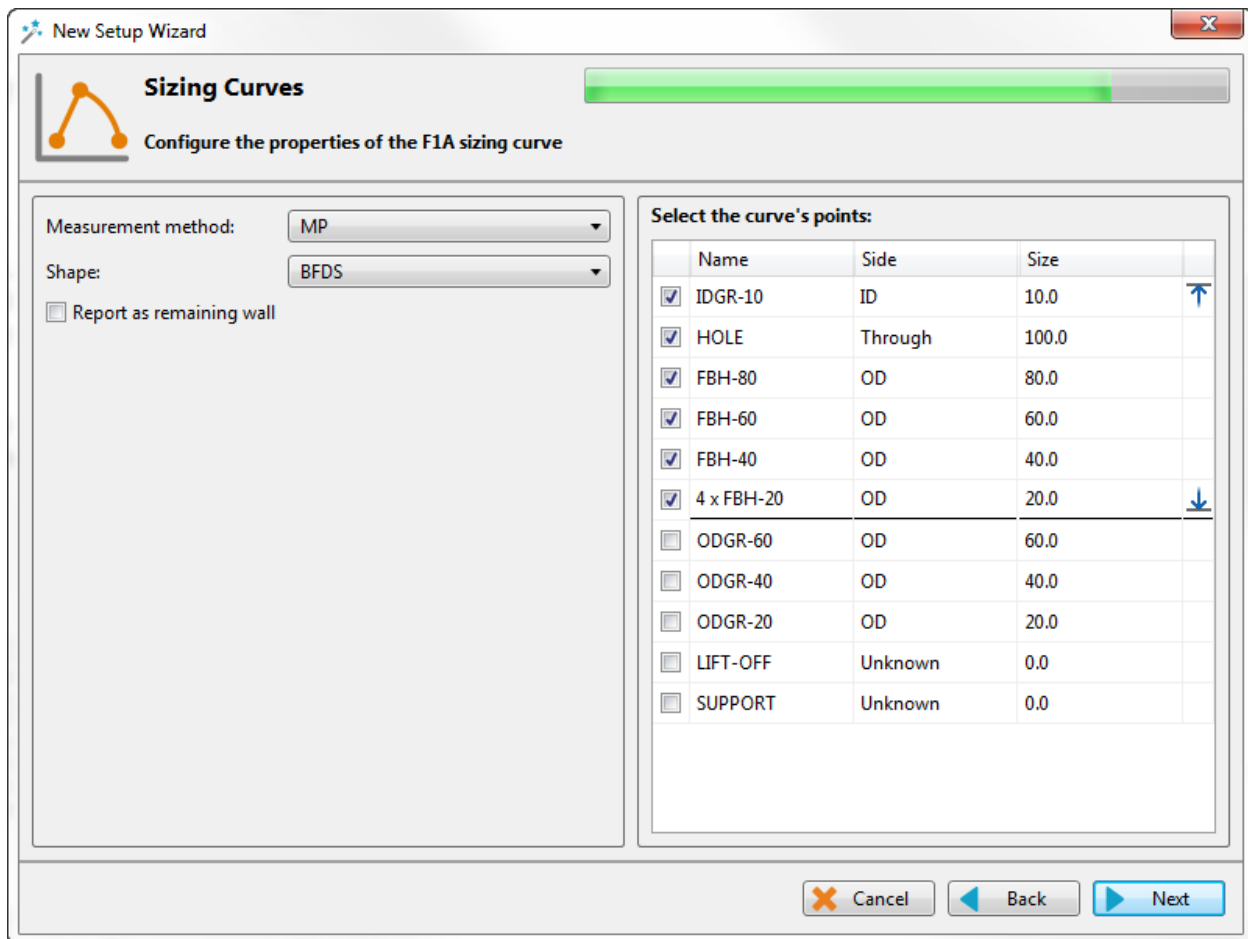

The measurement methods options are the same as what is described in the calibration section of this document. By default, the average peak option is set for absolute channels, and the peak-to-peak option is used for the differential channels.

The interpolation method can be selected with the *Shape* dropdown menu. Here is a short description of the available options:

1. **Best Fit (Dual linear) (for phase measurement only):**  
A curve with two linear segments representing ID and OD (or Near and Far) side calibration points in respect to phase.
2. **Best Fit (Dual Slope) (for phase measurement only):**  
A curve with two segments representing ID and OD (or Near and Far) side. The ID section is linear, and the OD section is polynomial. The OD side of the curve will need at least three points (including the hole) in order to trace a polynomial curve.
3. **Best Fit (Polynomial) (for phase and amplitude measurements):**  
Best polynomial (degree 2) interpolation within the measured calibration points (requiring at least three points).
4. **Connected Points (for phase and amplitude measurements):**  
Simple, point-to-point curve.

**5. Best Fit (Linear) (for phase and amplitude measurements):**

Best linear interpolation within the measured calibration points

**6. Best Fit (Dual Polynomial) (for phase and amplitude measurements):**

Polynomial (degree 2) interpolation with two segments for both ID and OD sides of the curve.  
Need at least three points.

The linear options are mostly used when few data points are available, while the Best fit (Dual Polynomial) option is a more precise method when your calibration tube has multiple defects.

Once the measurement method and the interpolation curve shape are chosen, you can select the curve points for each sizing curve previously created. The order in which the points appear in the list may influence your sizing curve. Make sure that the measured values of the calibration points are in ascending order on the list. You can set Magnifi to show the remaining wall instead of the defect size by checking the box *Report as remaining wall thickness*.

Click *Next* when you are done.

## INDICATION CODES

The *Indication Codes* page is used to define the entries that can be added to the report when analyzing the data.

Code	Description	Type	Automatic	Color	
COR	Corrosion	Defect			X
CRK	Crack	Defect			X
DNT	Dent	Defect			X
DSI	Distorted support indicatic	Defect			X
ERO	Erosion	Defect			X
NDD	No defect detected	No indication			X
OBS	Obstructed	Feature		Red	X
PIT	Pitting	Defect			X
PLG	Plugged	Feature		Brown	X
RST	Restricted	Feature		Yellow	X
WLL	Wall loss long	Defect			X
WLS	Wall loss short	Defect			X
WLT	Wall loss taper	Defect			X

When an indication is added, its abbreviation (code) is shown in the code pane, next to the data.

You can modify the default indications codes list by changing the parameter in the table. New indications can be defined by clicking on the *Add* button.

Click *Next* when you are done

## DISPLAY

The first *Display* window is used to set how the data is displayed during and after the acquisition.

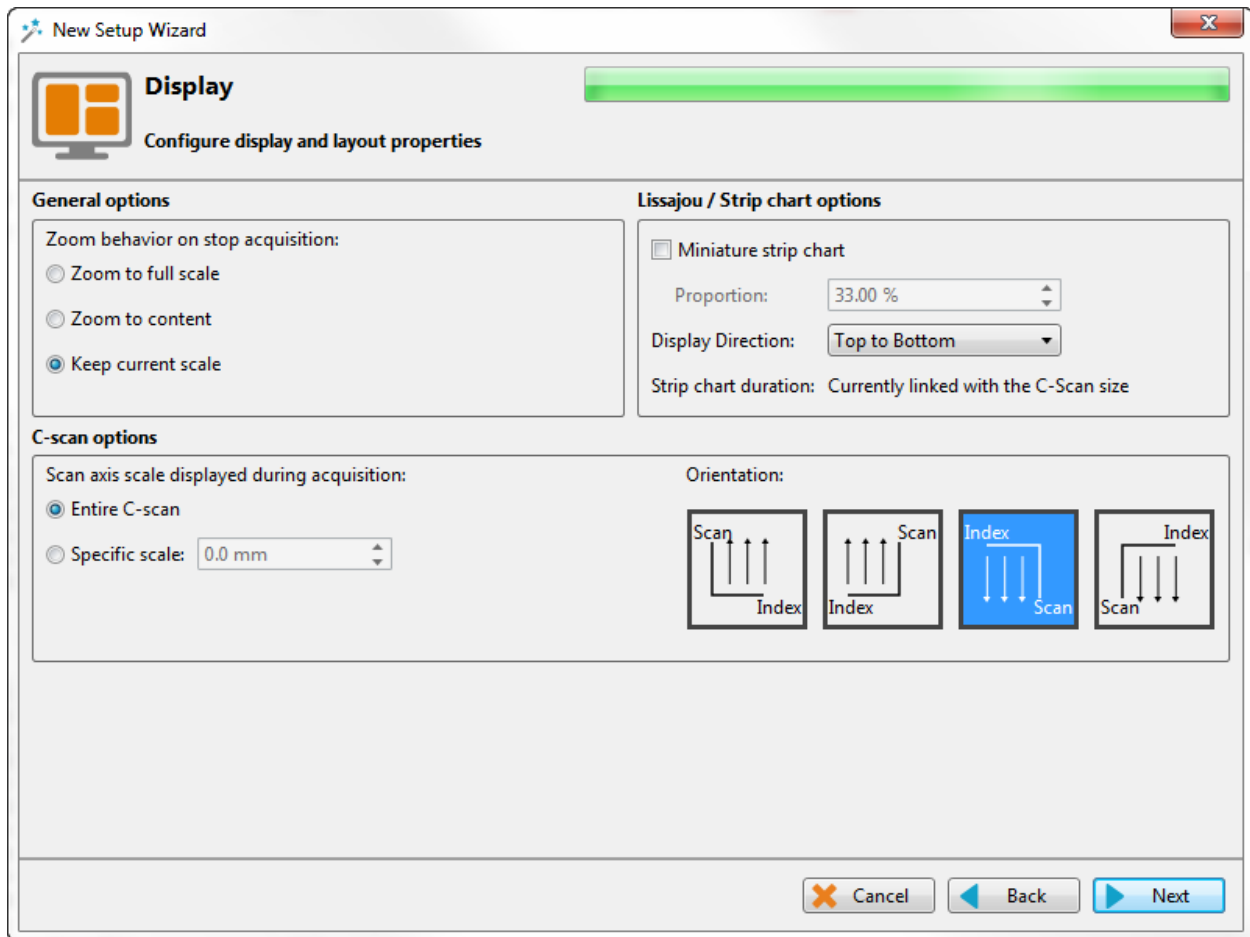

The scroll direction is the direction in which data appears on the screen. If you choose downward, the signals will go from the top to the bottom of the screen. If you choose the upward direction, the signal will go from the bottom to the top of the screen.

You can enable/disable the miniature strip chart under the Lissajous by checking/unchecking the box.

The strip chart duration is the length of a Strip chart window when the data is acquired.

Click *Next*.

The second *Display* window is used to set the layouts. Checking the tick boxes in this window will make the proposed layouts available in your setup. You will be able to switch from one the another via the layout tab. The " C " stands for code, " S " stands for Strip chart, " L " for Lissajous, " CS " for C-scan and " CS-3D " for 3D C-scan.

The layout with the blue background will be the one opened by default, which can be changed to your desired option.

Layouts can be readjusted at any time.

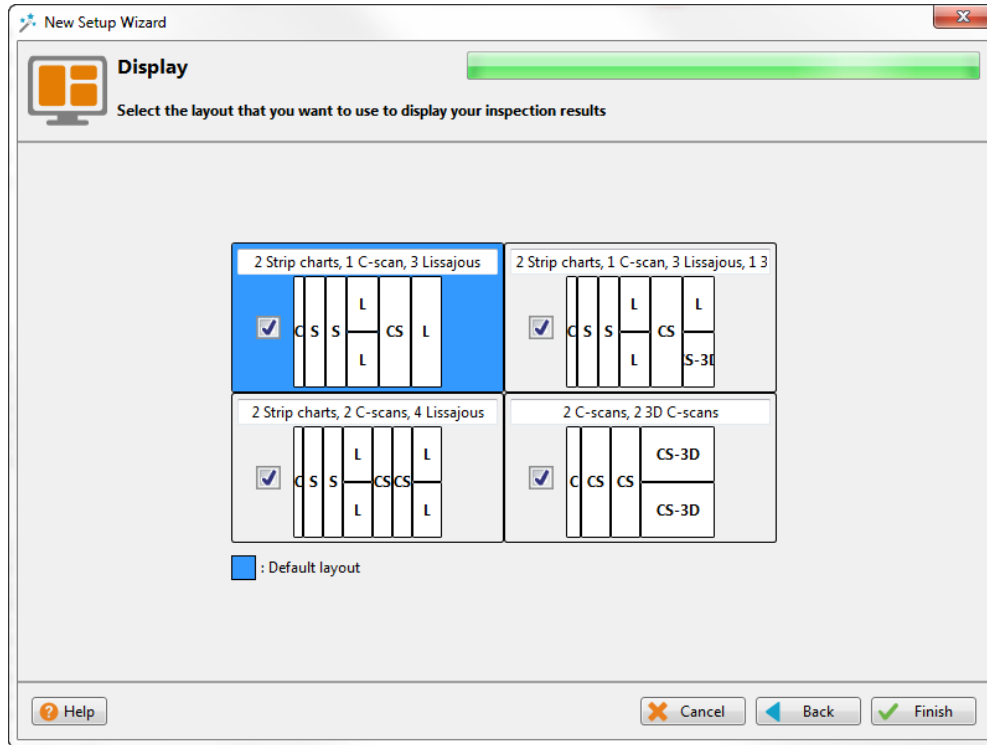

Click *Next* to complete the setup wizard process.

## SETUP MODIFICATIONS

Some parameters or preferences may need to be modified after the *Setup Wizard* process. To modify the parameter previously entered, you can go to the *Setup* tab in the *Frontstage* and click on the button associated with the parameter you want to change.

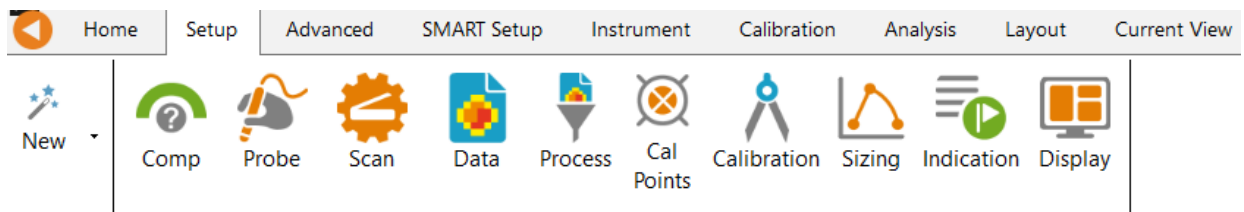

This will open one of the windows previously described, where you can change the values you originally entered. If applicable, go through the process by clicking on *Next*, and then click on the *Finish* button. This will apply the modification to the setup.

Advanced settings can be found under the *Advanced* tab of the *Frontstage*. If parameters are changed using the advanced settings, the information shown using the *Setup* tab may not match your actual setup.



## SMART SETUP TOOLS

Additional functions, which facilitate data analysis, can be set up under the SMART Setup tab.

### LOGBOOK

The first button on the left side under the SMART Setup tab allows you to enable or disable the logbook.

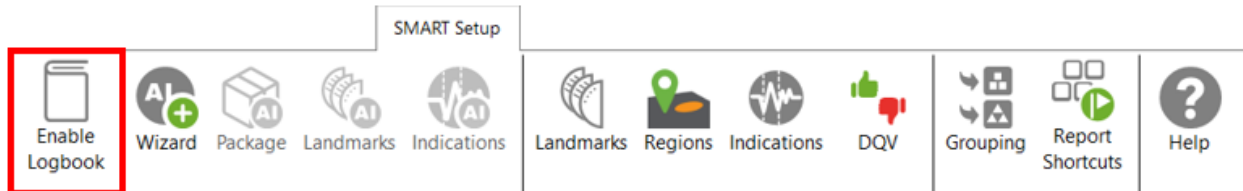





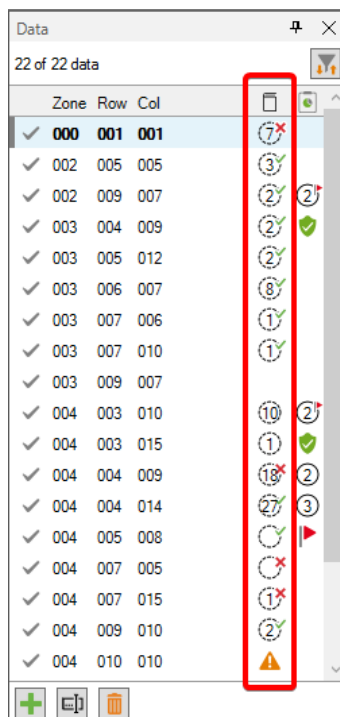

The logbook stores information about the analysis in addition to allowing the following functions: batch screening, seeing results at a glance from the data list pane and saving manual modifications made to the landmarks during the analysis.

The logbook stores the following information: landmarks (type, position, dimension, including manual modifications), indications (AI and conventional, label, position, dimension, etc.), indication grouping, and data quality validation results. When enabled, an additional column is added to the data file list to allow seeing results and to filter, sort, or analyze according to these results.



The following table shows the possible icons and their meaning:

Icon	Description	Meaning
------	-------------	---------

(empty)	Empty	No logbook entry associated with this file because it has not been screened yet.
	Dashed outline circle, without a number	Logbook entry associated with the file contains information such as landmark detection or regions. The absence of additional information on the icon reveals that no indication detection engine or DQV tests were enabled when the logbook was written.
	Dashed outline circle, with a number	Logbook entries associated with the file contains information such as landmark detection as well as detected indications. The number displayed inside the circle shows the quantity of potential indications detected. No DQV tests were enabled when the logbook was written.
	Dashed outline circle, with a green check mark	The green check mark indicates that the DQV test(s) passed on this file.
	Dashed outline circle, with a red cross	The red cross indicates that at least one DQV test(s) failed on this file.
	Dashed outline circle, with a number, with a green check mark	The logbook entries associated with this file indicates that potential indications have been detected by the detection engine and that the DQV test(s) passed.
	Dashed outline circle, with a number, with a red cross	The logbook entries associated with this file suggest that potential indications have been detected by the detection engine and that at least one DQV test(s) failed.
	Orange warning triangle	The AI detection tools identified an unusual situation. In this case, the level of confidence in the detection findings could be very low. Therefore, users should pay special attention when reviewing the detection results.

The logbook is saved within the inspection folder. Its data is written when a file is screened using the dedicated buttons in the Analysis ribbon. It is also automatically written when a file is loaded while the logbook is enabled, and no logbook entry existed for this file yet.

It is worth mentioning that the logbook also includes defects and landmarks, even if these have been detected with detection tools that do not use AI (conventional landmark detection and indication boxes). Also note that the automatic indication detection tools are not available if you use the acquisition license (ACQ).

# LANDMARKS

The Landmarks button is used to setup the parameters for landmark detection with conventional tools.

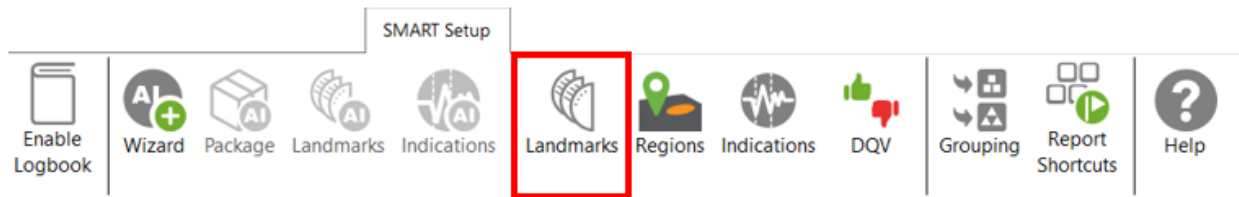

The Landmark Detection window is used to configure the automatic detection of features such as tube sheets and support plates. Landmarks are not mandatory and don't need to be set to have functional setup. They can however give a reference for the axial position in a tube. They can also be used by the software to trigger automatic acquisition sequences.

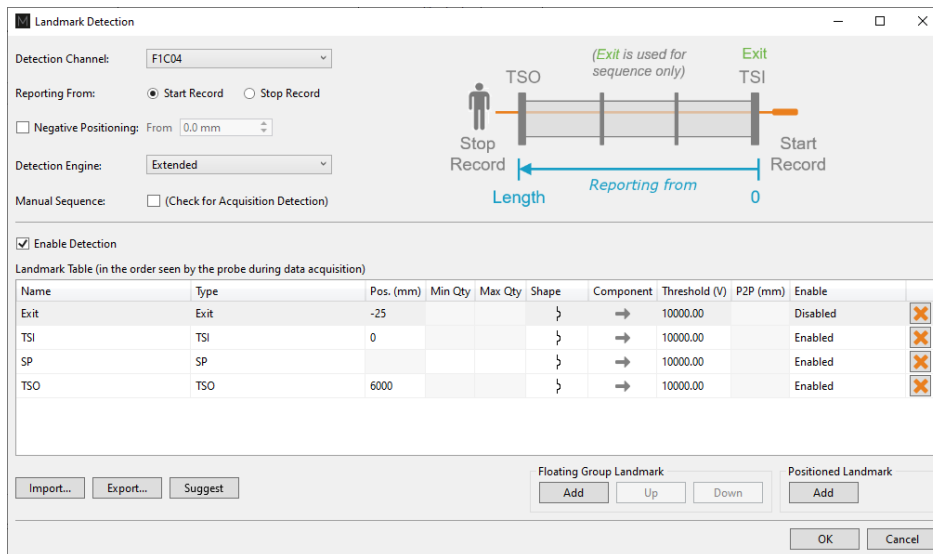

Three landmarks are created if you press on the Suggest button. The channel selected to detect these landmarks should be the lowest frequency absolute channel. The R\_ before the channel stands for Raw. This is the signal of the channel without software filter, rotation, or software gain applied.

You can base the position of your landmarks either on the location where you start to record (usually the tube entrance, opposite from the operator position) or on the place you stop to record (usually the operator side).

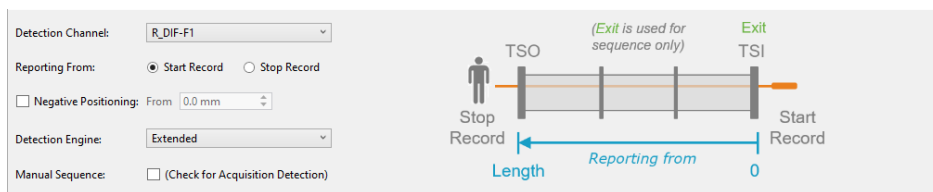



In the above example, the Exit landmark is detected when the probe exits the tube at its outer end. It has a negative position because this event happens before entering the tube. It is enabled only when doing the acquisition.

TSI is the first tube sheet encountered when the probe is pulled. TSO is the last tube sheet encountered at the end of the acquisition.

Landmark detection can be set up manually by describing the shape, component, and voltage threshold that will trigger the detection. The Shape describes the appearance of the signal when the landmark is reached. If a differential signal shape is chosen, the Peak-to-Peak distance (“P2P”) will also be needed. The Direction is the projection axis (horizontal or vertical) of the Lissajous signal that will be taken to trigger the landmark. And the Threshold is the voltage amplitude threshold.

Landmarks can be calibrated on real signals; in this case, there is no need to change these parameters as they will be automatically measured by the software. It’s important to set the landmark positions as accurately as possible. If the position is not accurately set, the software might prevent their automatic detection since it won’t be at an expected position.

The Type field is a name that associates the calibration point with the landmark. If landmarks share the same Type, they will be calibrated at the same time using the same point and process. To associate two landmarks with the same Type, their signal must be the same. If support plates of the same geometry are present in a bundle, they can share the same Type. In the above example, TS1 and TS2 don’t share the same Type because one is triggered when the probe goes inside the tube and the other is triggered when the probe exits the tube.

The Detection Engine drop-down menu can be set to Legacy or Extended. With the Legacy mode, all the landmarks need to be entered with the right position. The system will look for the exact number of landmarks entered at positions close to those entered in the table. With the Extended mode, the system will look for a number of landmarks between the Qty max and the Qty min. With this mode, the exact number of support plates don’t need to be constant or known.

## REGIONS

The Regions option allows the user to define inclusion/exclusion zones based on Landmarks. This is used to categorize the data to process correctly. For example, they can be useful for restricting the detection of channel saturation to an area within the tube or specify an automatic analysis type for a given region (e.g., under the tubesheets).

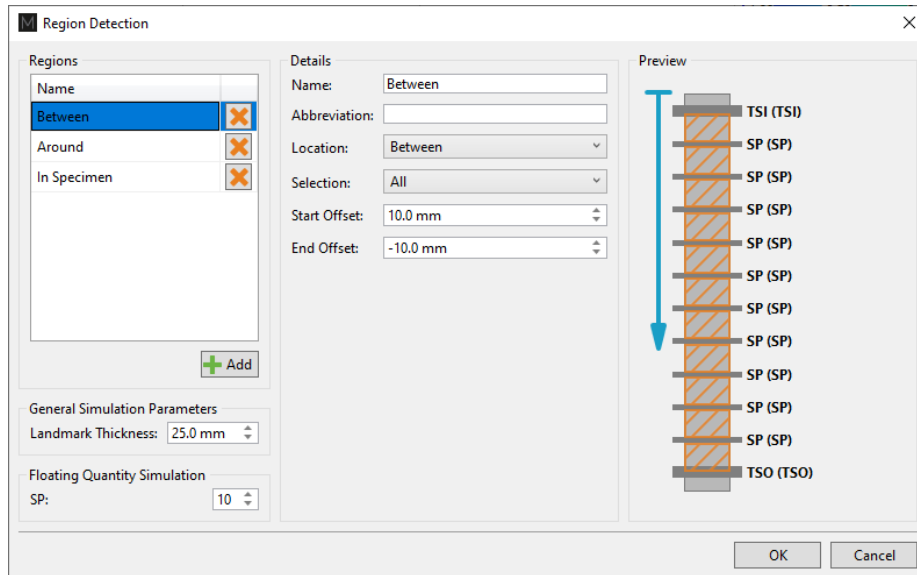
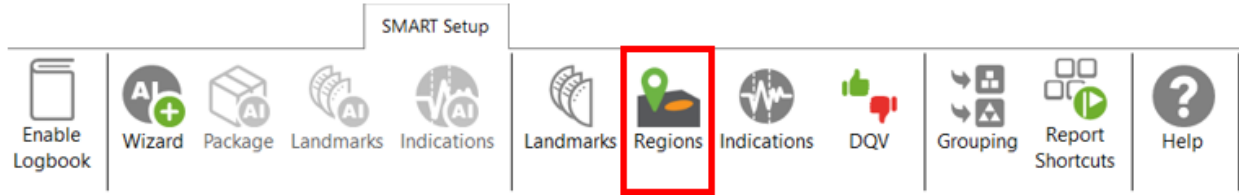

If you are using the conventional detection tools, you can set up the regions according to the automatic analysis tools you will use with the Indications and DVQ buttons (described later).

## INDICATIONS

The Indications module allows the user to define various zones or even waveform types to trigger a certain detection threshold.

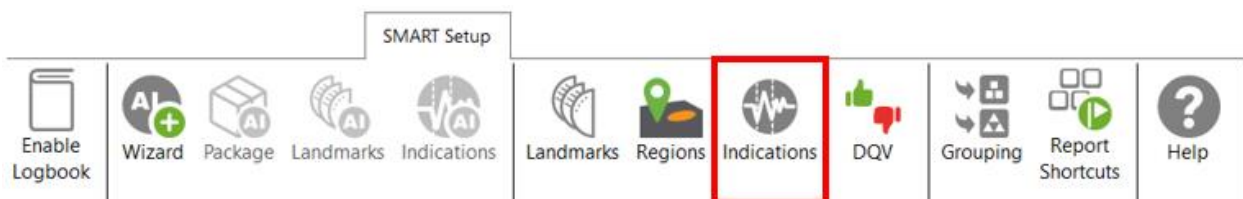

These detection zones can be applied to conventional channels and C-scan channels. The Label is the name that will appear in the Code view.

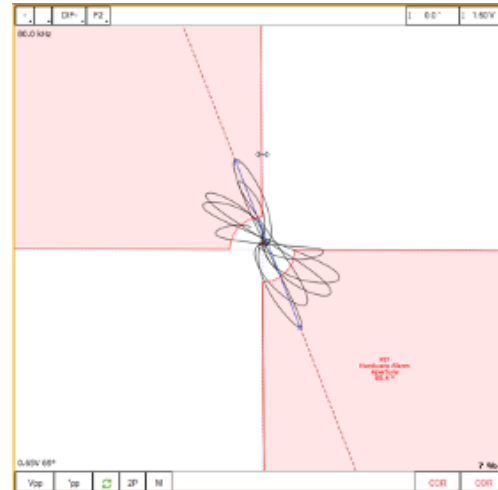
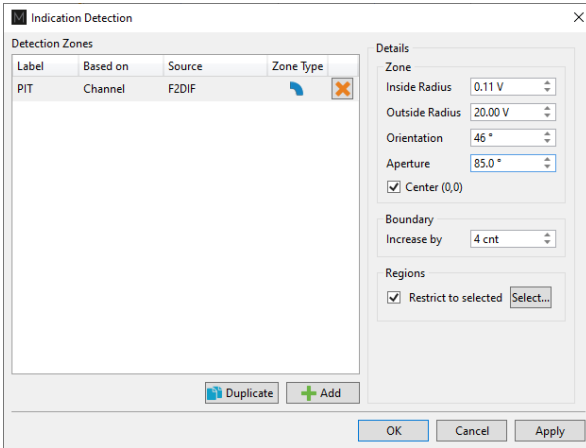

There are five zone types:

	Absolute pie
	Differential pie
	Centered rectangle
	Rectangle
	Over or under a horizontal or vertical threshold

And seven waveform types:

	Up
	Down
	Down-up
	Any direction
	Up-down
	Down-up-up
	Up-down-up-down

Each zone or waveform can be linked to a defined region, and thresholds can be set. The zone types also include the boundary setting to prevent signal oscillation from triggering unnecessary detections.

Detection zone parameters can also be set by clicking on the Lissajous of the used channel and activating the Edit Alarm option on the Current View tab.

The detected indication can be found in the Indication window, which can be activated in the Layout tab.

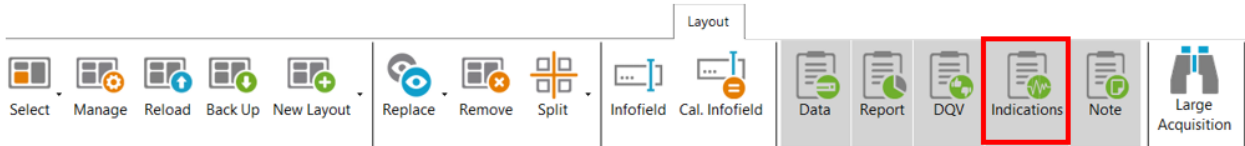

Clicking on an indication in the pane instantly positions the cursor on the selected indication in the Strip chart view. If you click on an indication in the code view (described later), the associated indication is highlighted in the Indications pane.

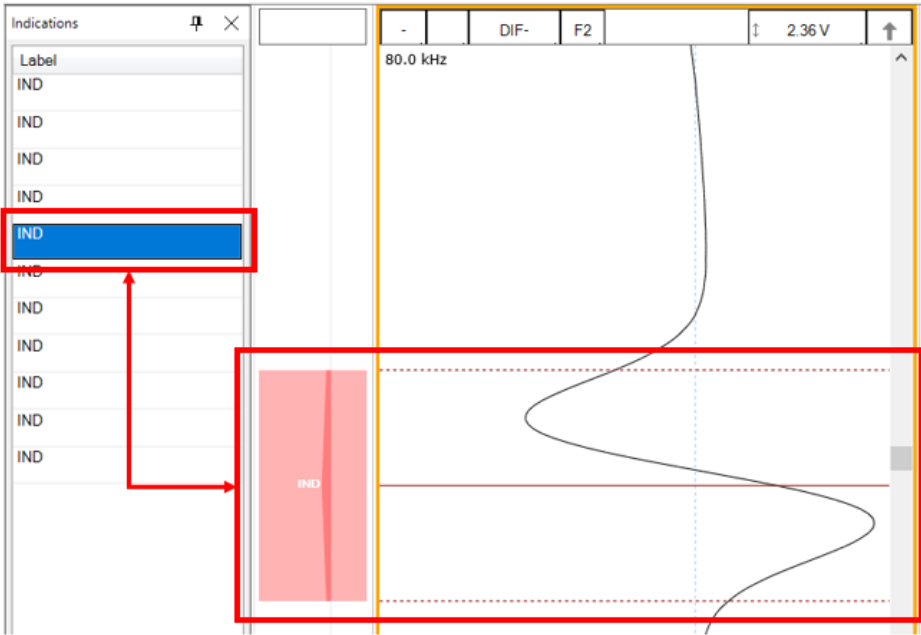

## DATA QUALITY VALIDATION (DQV)

Data Quality Validation allows defining tests to validate the quality of the data.

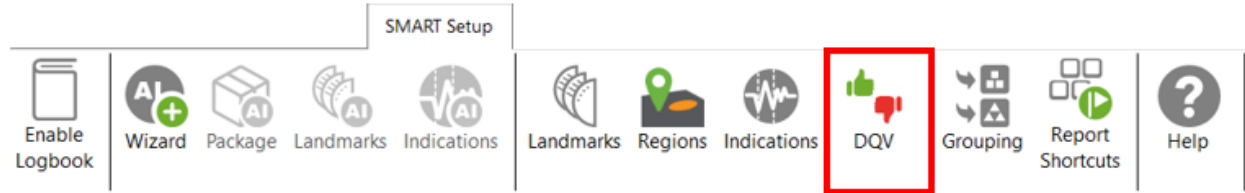

Five test types are available. To add a test, click on the Add button on the DQV page and select the test type with the drop-down menu. Parameters associated with this test can be changed in the Details section of the DQV window.

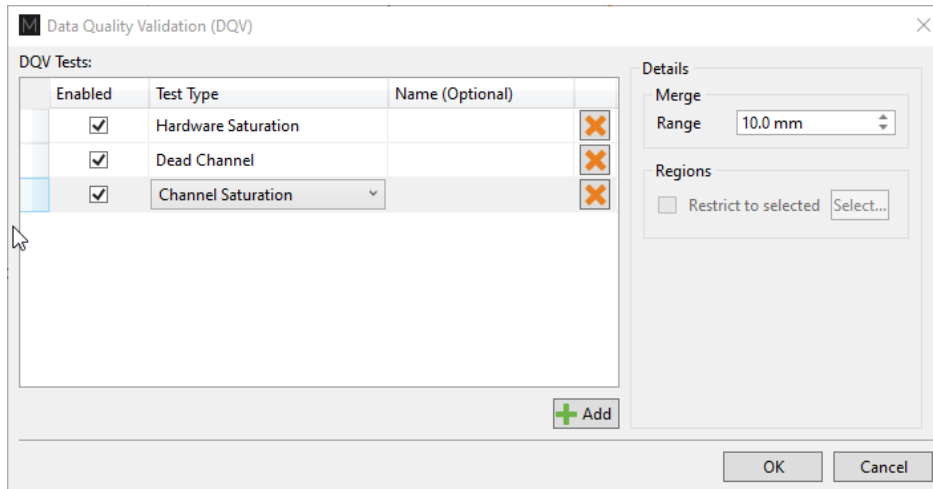

- **Dead Channel:** Verify that channels are reading a signal whose amplitude is above a defined threshold. An amplitude that remains below the threshold throughout the scan indicates a dead channel.
- **Landmark Detected:** Verify the presence of all the selected landmark names in the Details section. To validate full tube-length of straight bundles for ECT bobbin data using AI detection, select this option and check the TSI and TSO landmarks. When AI setup for landmarks is completed and the TWH calibrated, the DQV test will automatically use the AI results to perform the test.
- **Hardware Saturation:** Verify if signal saturation appears on raw channels. The merge field allows grouping a zone together for which the test has failed. This function avoids having many notifications if the test fails several times in one area. This test can be limited to a specific region, for example, the areas inside the tube.
- **Channel Saturation:** Verify if signal saturation appears on calibrated channels. The merge field allows group a zone together for which the test has failed. This function avoids having many notifications if the test fails several times in one area. This test can be limited to a specific region.
- **C-scan Saturation:** Verify if signal saturation appears on C-scans. The merge field allows grouping a zone together for which the test has failed. This function avoids having many notifications if the test fails several times in one area. This test can be limited to a specific region.

The results of the DQV tests can be found in the DQV window, which can be activated in the Layout tab.

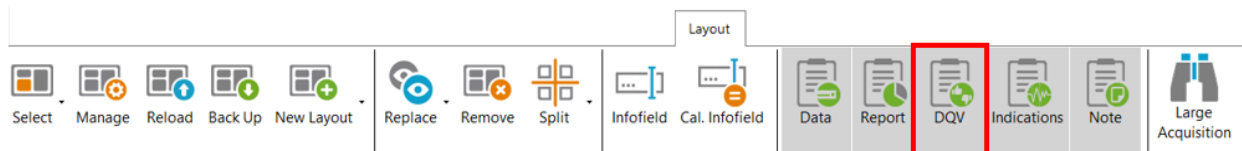



The screenshot shows a window titled 'DQV' with a table of test results and a section for failures.

Test	Result
Channel Saturation	✘ 8 errors
Hardware Saturation	✘ 2 errors

Below the table is a 'Failures' section with a table of criteria:

Criteria	
Hardware Saturation	!
Hardware Saturation	!

At the bottom of the window, there are tabs for 'Indications' and 'Note'.

## GROUPING

The grouping tool can help the analyst find critical indications for review as it categorizes and groups the automatically detected indications.

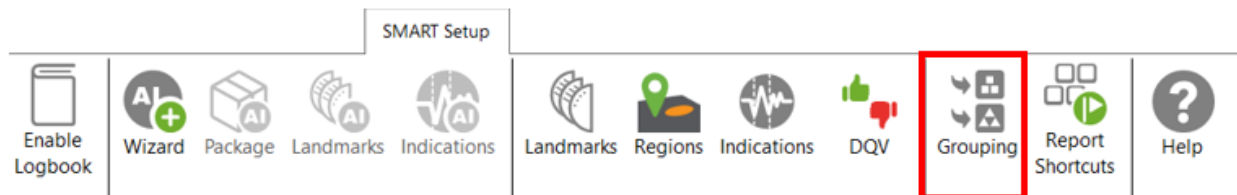

The Grouping menu offers a default configuration with three predefined categories:

- Support Plates
- Critical
- Less Critical

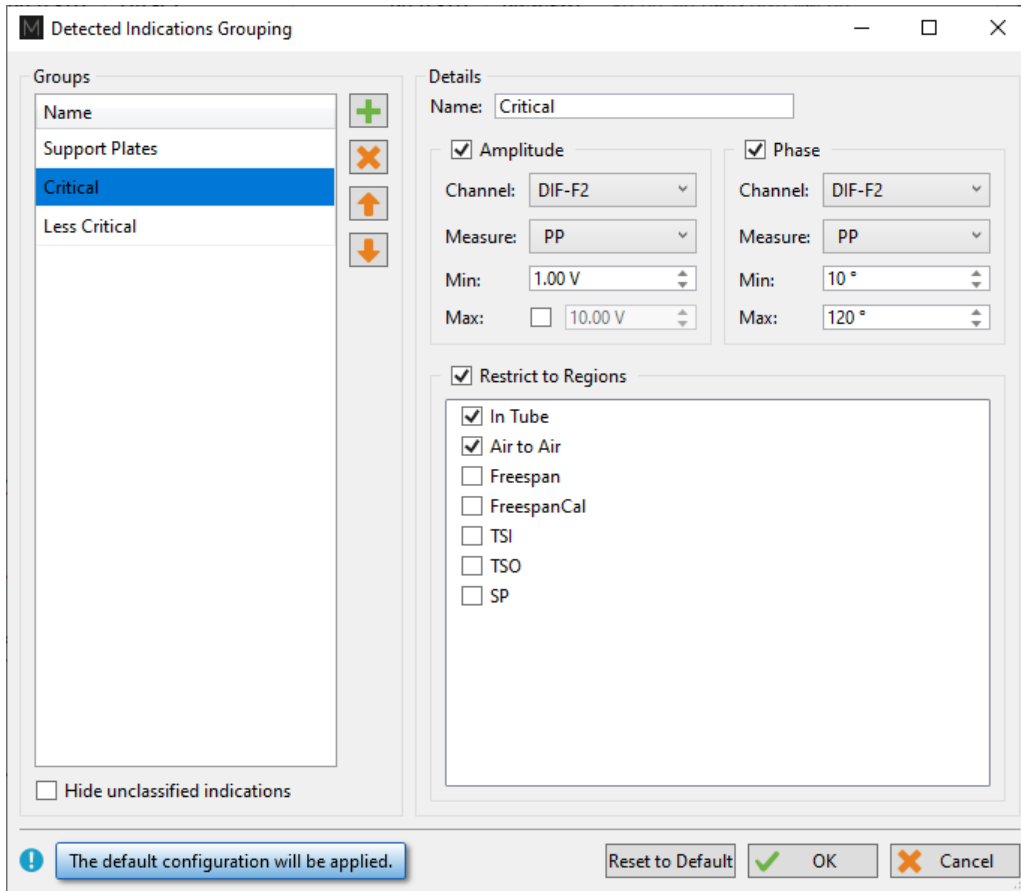

The Details section of each group shows the parameters defining the conditions that must be met for a detected indication to be classified in this group. The user can modify all parameters.

By default, the Support Plates group is configured with the mix channel with a Peak-to-Peak (PP) measurement method, and Max/Min threshold values are set for amplitude and phase. For this group, the criteria are limited to indications detected under the SP regions. As a result, the indications detected under support plates for which all conditions are true will fall into this category.

Critical and Less Critical are two other groups predefined in the Grouping window. Both groups are set on DIF-F2 channel, but with different Amplitude/Phase measurement settings. In both cases, the grouping criteria is restricted to In Tube and Air to Air (for calibration tubes) regions, which covers the full-tube length data.

It should be noted that each automatically detected indication can only be categorized in a single group. Also, the grouping operation is executed according to the order of the groups defined in the Groups list. Therefore, if a given indication meets all the criteria of the first group, it will be categorized in this group. If not, it will be passed to the following group. If it meets all the criteria of the second group, it will be categorized into this one. If not, it will again be passed to the next group, and so on. If an indication does not meet the criteria of any group, it will be placed in the Unclassified group. This implies that every single indication will be categorized, and none can appear simultaneously in more than one group.

New groups can be created with custom parameters.

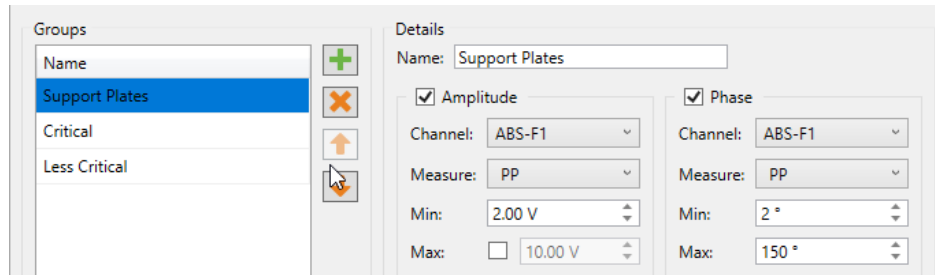

It is also possible to remove a group or use the up/down arrow keys to change the group priority within the list.

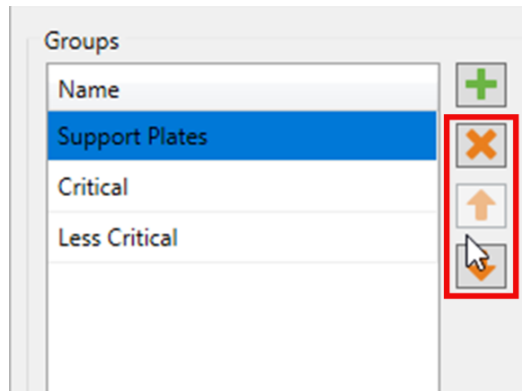

In the Front stage interface, the Grouping results will be displayed in the Indications pane.

Indications ⌵ ×

10 of 10 results

Label	Ampl.	Phase
⌵ <b>Critical (4)</b>		
IND	14.15 V	82 °
IND	3.40 V	83 °
IND	2.78 V	106 °
IND	7.06 V	16 °
⌵ <b>Less Critical (4)</b>		
IND	1.02 V	111 °
IND	1.00 V	40 °
IND	1.27 V	56 °
IND	1.13 V	73 °
⌵ <b>Unclassified (2)</b>		
IND		
IND		

DQV **Indications** Note

To help the analyst focus on the most relevant detected indications furthermore, it is possible to hide the Unclassified indications. To accomplish this, check the box “Hide unclassified indications” at the bottom of the Grouping menu and click on OK.

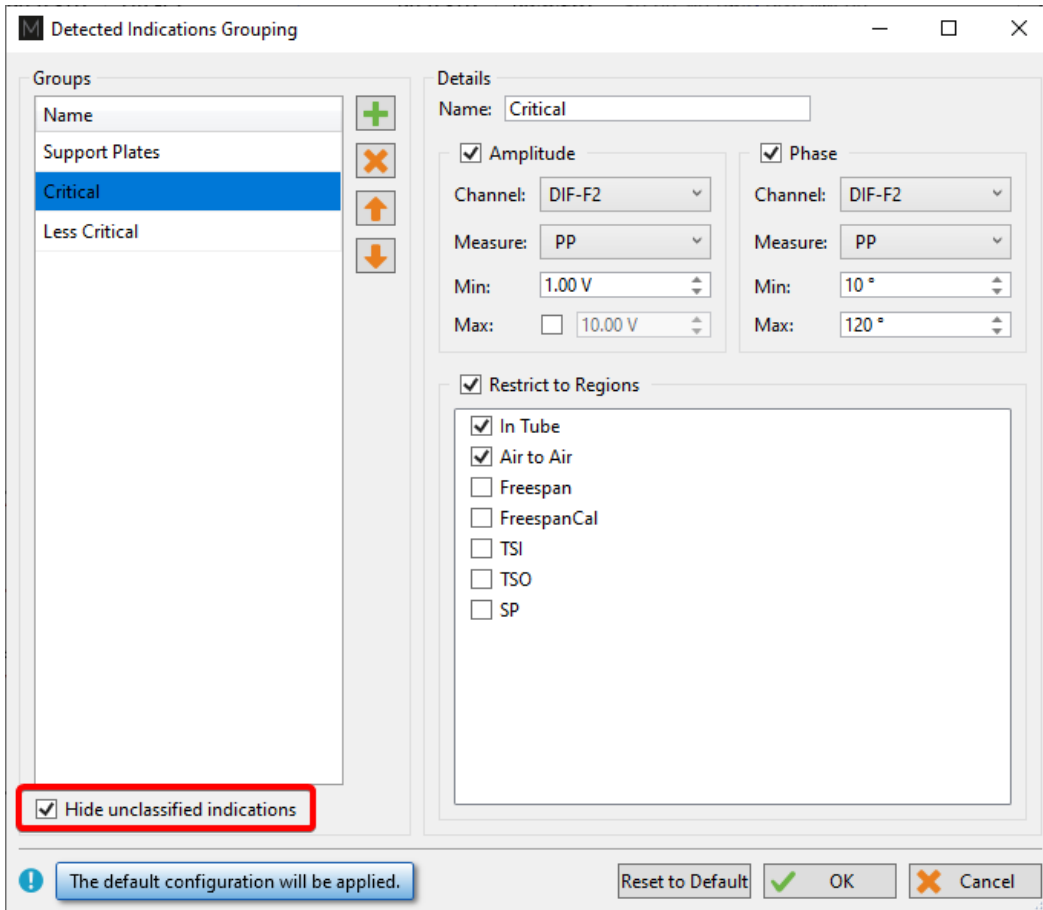

Enabling this option influences the following elements of the software:

- Indications pane;
- Code view;
- Logbook column.

The images below compare them when the Unclassified indications are shown (left) and when they are hidden (right).

When the option is enabled, the Indications pane will not show the “Unclassified” group. The count in the header serves as a reminder to the user that not all indications are currently shown.

Indications 🔍 ✕

26 of 26 results

Label	Ampl.	Phase
<b>⤴ Critical (1)</b>		
IND	1.53 V	17 °
<b>⤴ Less Critical (5)</b>		
IND	1.00 V	14 °
IND	0.93 V	10 °
IND	0.84 V	18 °
IND	0.76 V	17 °
IND	1.20 V	19 °
<b>⤴ Unclassified (20)</b>		
IND		
IND		
IND		
IND		
IND		

DQV **Indications** Note

Indications 🔍 ✕

6 of 26 results

Label	Ampl.	Phase
<b>⤴ Critical (1)</b>		
IND	1.53 V	17 °
<b>⤴ Less Critical (5)</b>		
IND	1.00 V	14 °
IND	0.93 V	10 °
IND	0.84 V	18 °
IND	0.76 V	17 °
IND	1.20 V	19 °

DQV **Indications** Note

In the Code view, the red markers from the Unclassified indications have been removed.

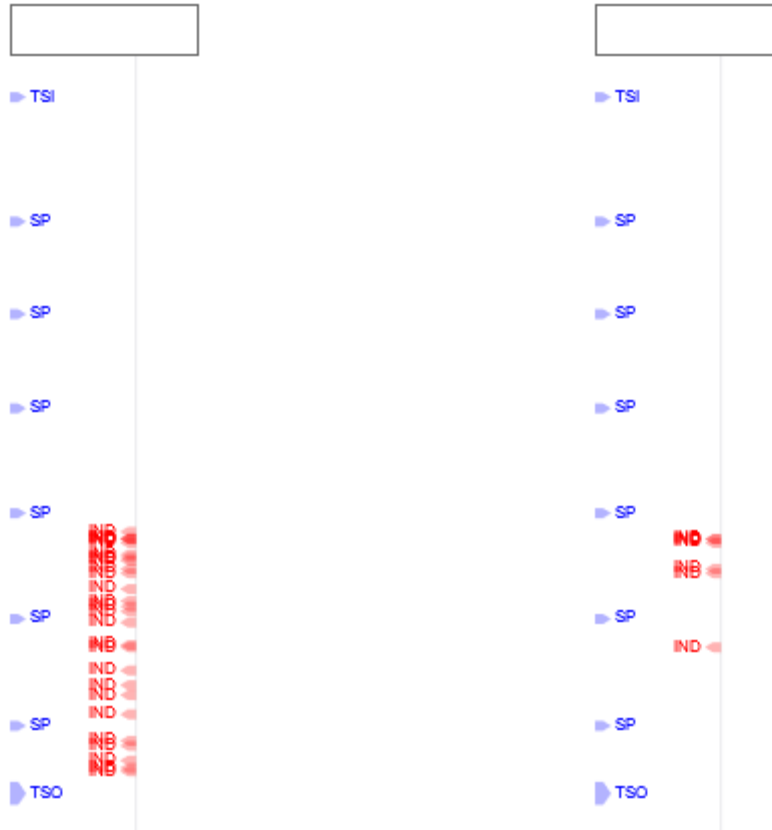

In the data file list, the number shown in the Logbook column represents the number of visible indications, matching the number shown in the header of the Indications pane.

Data		↑	×
7 of 7 data		⏏	
Row	Col		
✓	201000001		
✓	201004005		
✓	<b>201006009</b>	(26)	
✓	201006016		
✓	201024022		
✓	201025017		
✓	201025019		

Data		↑	×
7 of 7 data		⏏	
Row	Col		
✓	201000001		
✓	201004005		
✓	<b>201006009</b>	(6)	
✓	201006016		
✓	201024022		
✓	201025017		
✓	201025019		

## REPORT SHORTCUT

Keyboard shortcuts can be used to make entries in the report. By opening the shortcut window, it is possible to select a channel with a measurement method and to associate an indication with it.

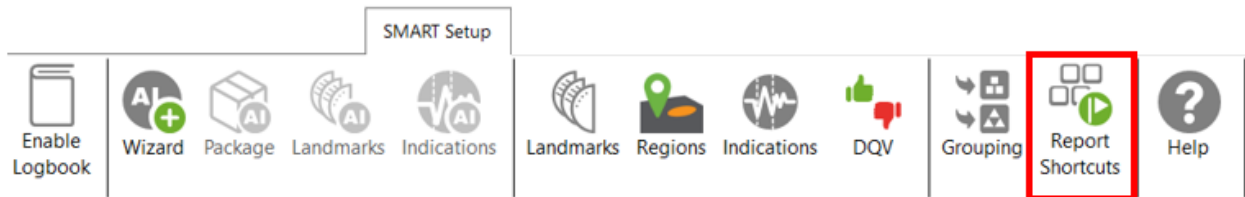

For example, we could use the differential channel F2 with a Peak-to-Peak measurement method to enter pits in the report.

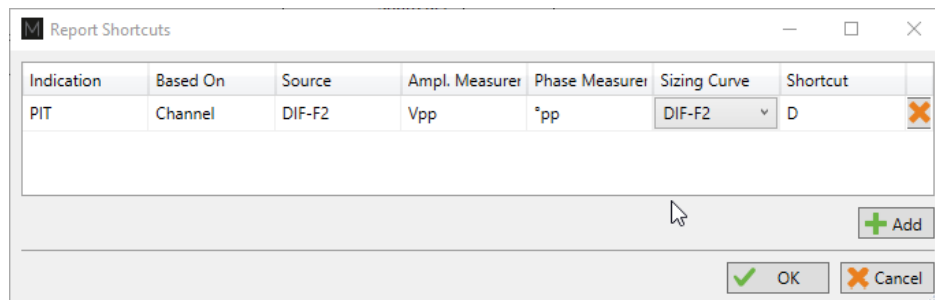

To select a key, press the Shortcut field and press the desired key on your keyboard. It is possible to use a single key or a combination of keys such as ALT+D, for example.

When a report entry is made with the keyboard shortcut, the abbreviation of the type of indication displays momentarily on the corresponding Lissajous.

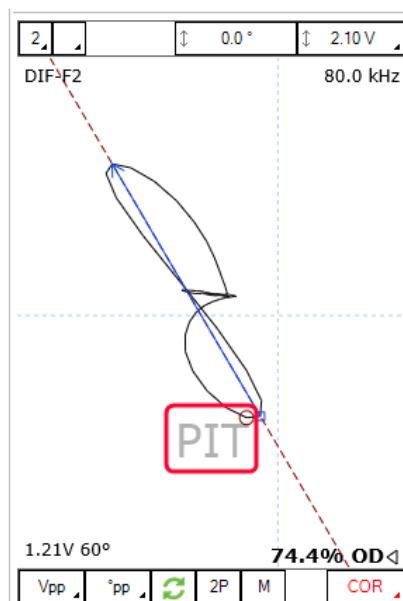

## DATA SCREENING

Data screening set up with the SMART Setup tools can be performed by the two buttons on the left under the Analysis tab.

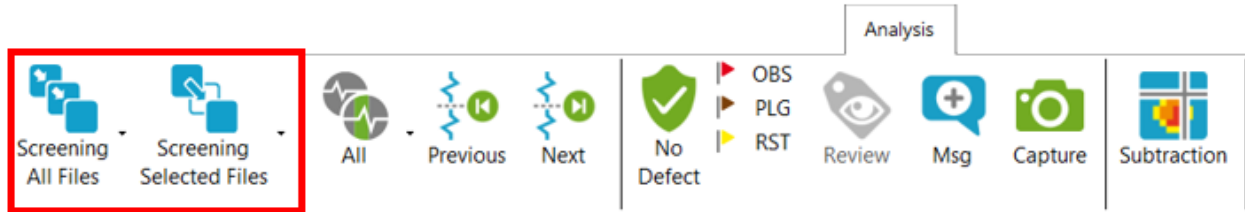

It is possible to run analysis on a selection of files or all files. The analysis is typically performed on all files when the setup and calibration are adequate. The results are recorded in the logbook and can be viewed in the Data window.

## DATA LIST

Magnifi will save a file for each inspected tube. The file names are defined by creating the list of tubes.

This list can be created in the *Data List* section of the *General* tab of the *Backstage*.

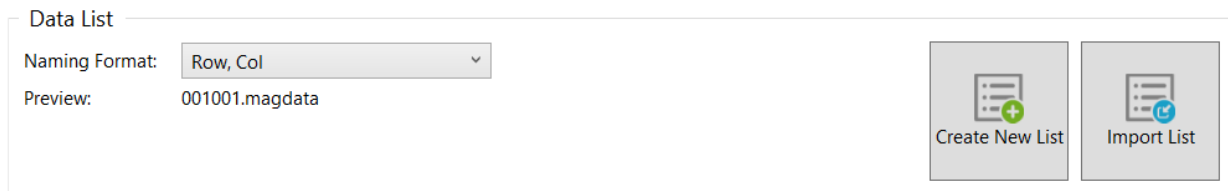

Four options are available to set the filename format:

- 1. Free format:**  
Each file has a custom name. Can also be defined from the Data tab of the Front Stage.
- 2. Prefix:**  
The file name includes a defined prefix followed by a sequential number.
- 3. Row, Col:**  
Row number, Column number. Mostly used for tubing inspections.
- 4. Zone, Row, Col:**  
Zone number, Row number, Column number. Mostly used for tubing inspections.

Click on the *Create New List* button. The displayed window will be different depending on the chosen filename format.

For the *Row, Col* option, enter the number of rows, the starting row number and row interval. You can then enter the number of tubes per row in the *Nb. of Columns* fields of the table. Click on *Create* to



generate the list of tubes. You can also use the *Create & New* button to add another set of tubes to your list.

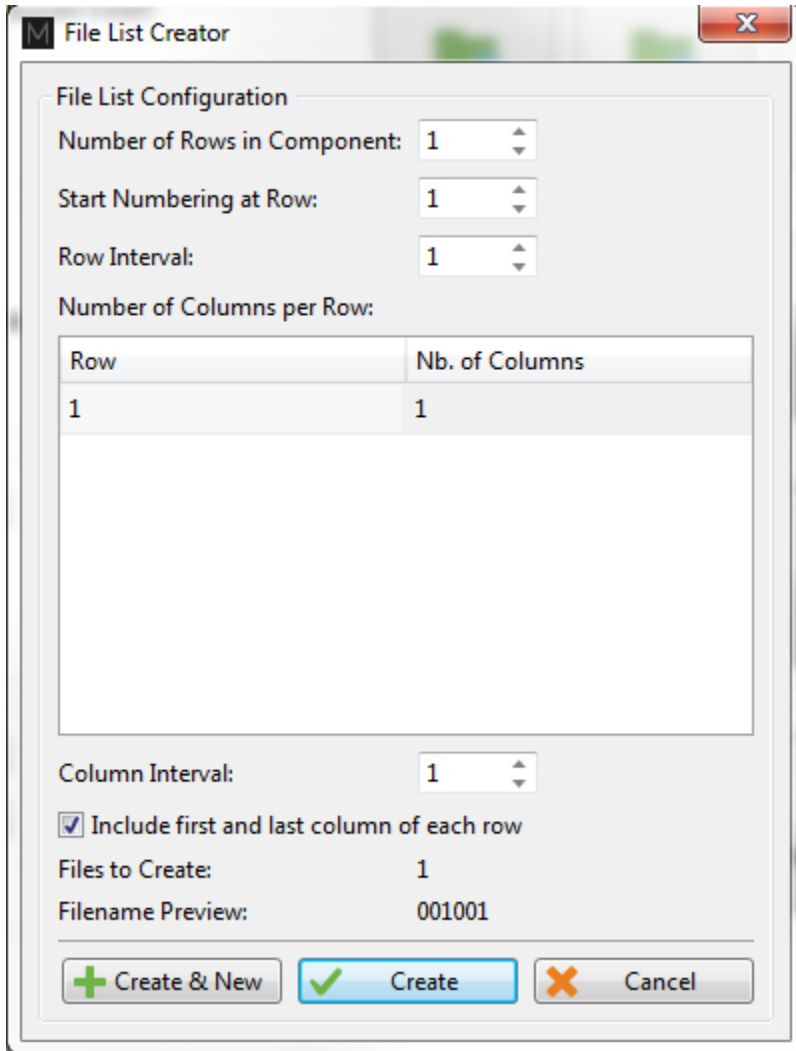

The same principles apply to the other file formats, except for the *Free format* option for which the file name(s) needs to be entered manually in the *Data* window of the *Frontstage*.

The tube list can also be imported from another project using the *Import List* button. The tube list file can be found in the *Inspection* folder. It is also possible to import a list created in the *TubePro* software (available from Eddyfi).

## PERFORMING AN ACQUISITION

5. If you are in the *Backstage*, move to the *Frontstage* by clicking on *Start/Resume* button.
6. Click on the *Connect* button under the *Instrument* tab. This will open the *Instrument configuration* page. Click on the line showing the instrument to which you want to connect and then click *Connect*.



Note: Your Ectane firmware version may not match the version of Magnifi you are using. If this is the case, a red and white X icon will be shown in the *Status* field of the *Instrument connection* window. To download a matching version to your Ectane, click on the *Config.* button and then click the *Send firmware to the instrument* button of the *Instrument configuration* window.

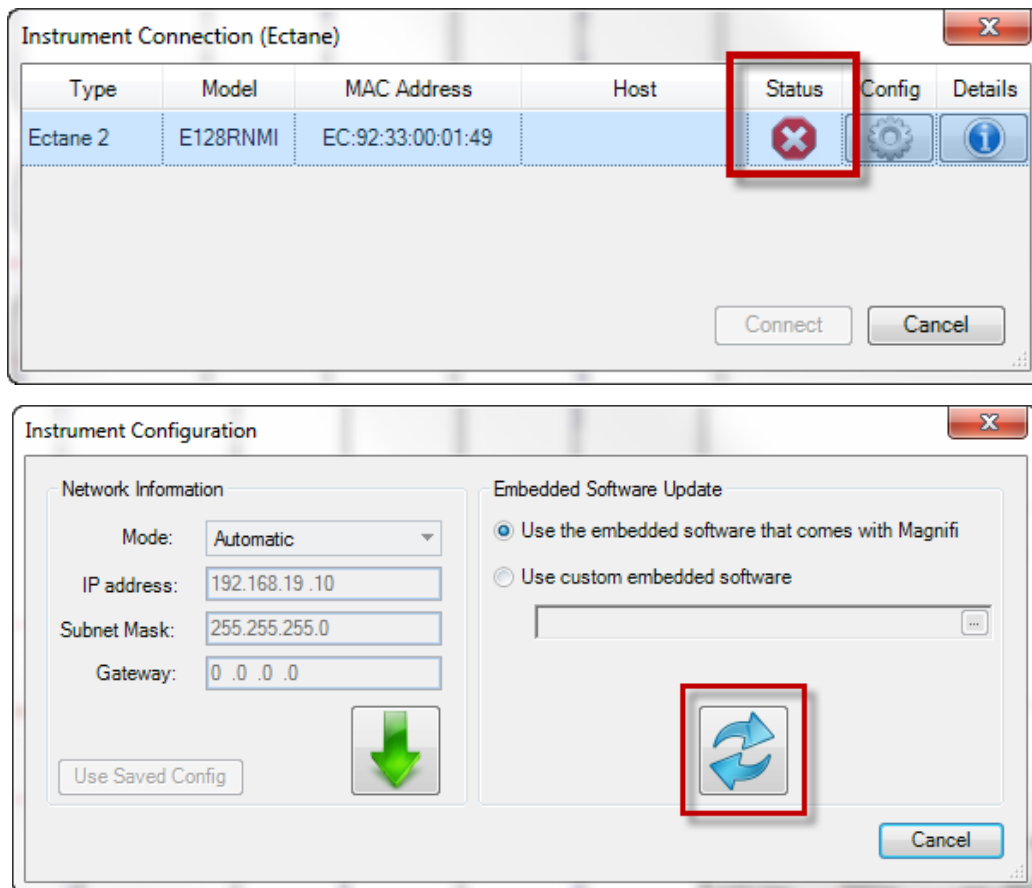

Two acquisition modes are available in Magnifi: *Setup Mode* and the *Acquisition Mode*. *Setup Mode* is used to scan your calibration tube and make the necessary adjustments on your setup without saving the data automatically. Acquisition mode is used for the inspection. In this mode, the software automatically saves the acquired data using file names based on the tube list.

7. For the calibration phase, go to *Setup Mode* by clicking on the *Setup Mode* button under the *Home* tab. This mode is active when the *Setup Mode* button is grayed.

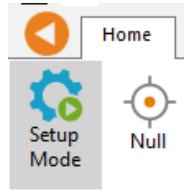

8. Plug the DefHi® probe on the Ectane 160-pin connector.
9. Bring the probe head in a clear area in your standard and balance the probe by clicking on the *Null* button under the *Home* tab, or press F6 on your keyboard.
10. Push the probe head all the way through the tube so that it exits the tube.
11. Start the acquisition by clicking on the *Acquire* button under the *Home* tab or by pressing the F2 on your keyboard.
12. Pull the calibration tube at the appropriate speed
13. When it's done, press the *Stop* button or F2 again on your keyboard

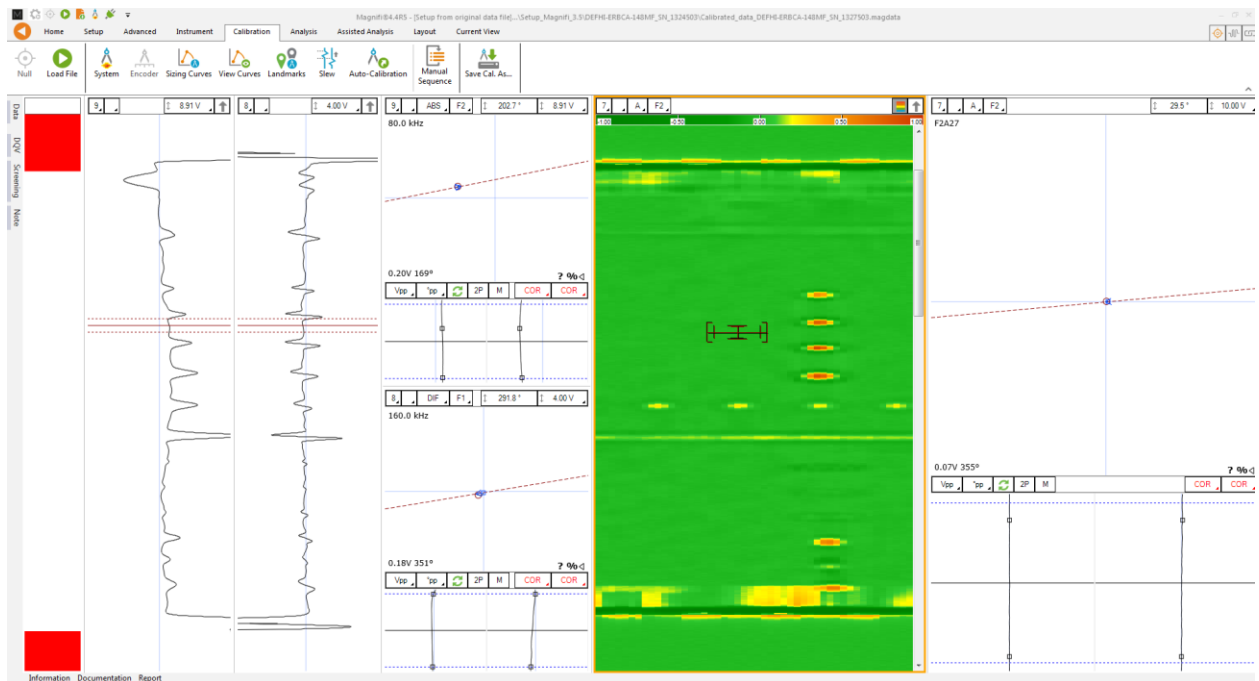

Note that a red zone in the code pane means that at least one of the raw signals is saturated. This is usually the case when your probe is out of the tube.

## VISUALIZING THE DATA

Multiple options are available to select your data and to measure it. The following describes useful functions to do so:

### DISPLAYED CHANNEL

There are four buttons at the upper right corner of the C-Scans, Strip charts and Lissajous windows. These buttons are used for the channel selection.

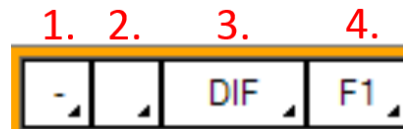

1. Links Strip charts and Lissajous to the same channel. For instance, if a Lissajous and a Strip chart are both set to 1, setting the Lissajous to DIF-F1 will also set the associated Strip chart to this channel.

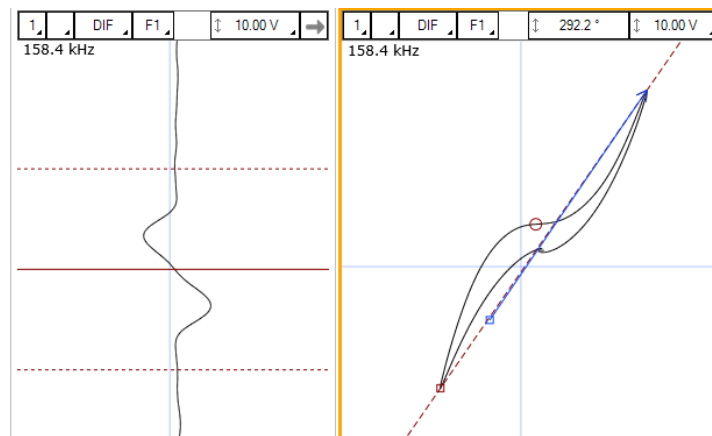

2. Clicking on the corner with the black triangle gives the list of available channels. Click on the desired channel to select it. Right-click or Left-click on this button to switch to the following or previous channel in the list.

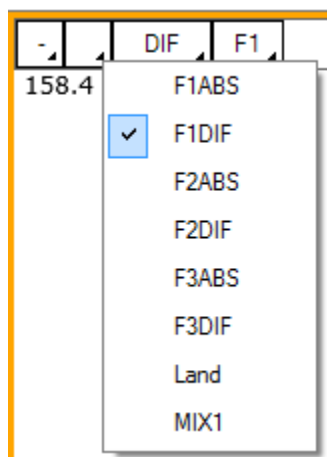

3. Same principle as 2., but for the type of channel only (absolute or differential).

- Same principle as 2., but for the frequencies only.

## STRIP CHART AXIS ORIENTATION

The Strip charts are a projection of the Lissajous on the vertical or horizontal axis. To switch from one axis to another, click on the box showing an arrow at the upper right corner of the Strip chart.



## ZOOMING

On the strip chart/or on a C-scan, hold the right button of your mouse and drag on the zone of interest to zoom in this section. This operation can be done in both axis for the C-scan.

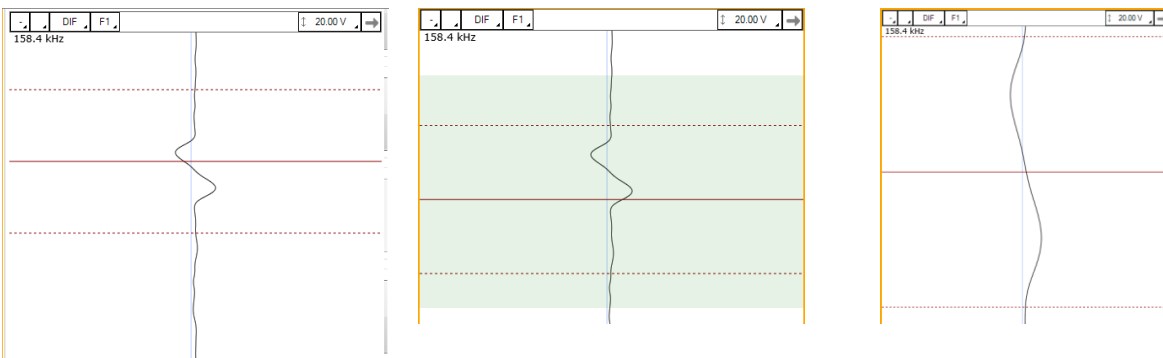

To zoom out, right-click on the Strip chart and select *Previous Zoom* or *Full Extent*.

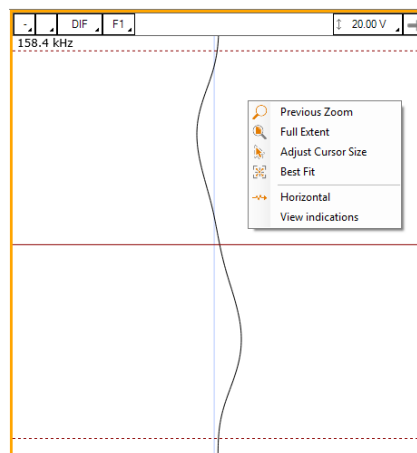

## ADJUSTING THE CURSOR LENGTH

On a Strip chart, the cursor is divided by 3 lines. The dotted lines represent the limit of your cursor and the full line is the center of what you have selected.

Only the portion of data between the dotted line will be shown in the Lissajous.

To adjust your cursor length, hover your mouse over the dotted line, and click and drag the left mouse button. This will adjust the 2 dotted line symmetrically. To adjust only one dotted line, do the same operation, but with the right button of your mouse.

## ADJUSTING THE SCALE

The scale of a window (Lissajous or Strip chart) can be modified by clicking on the scale button with the left button (decrease scale) or the right button (increase scale) of your mouse.

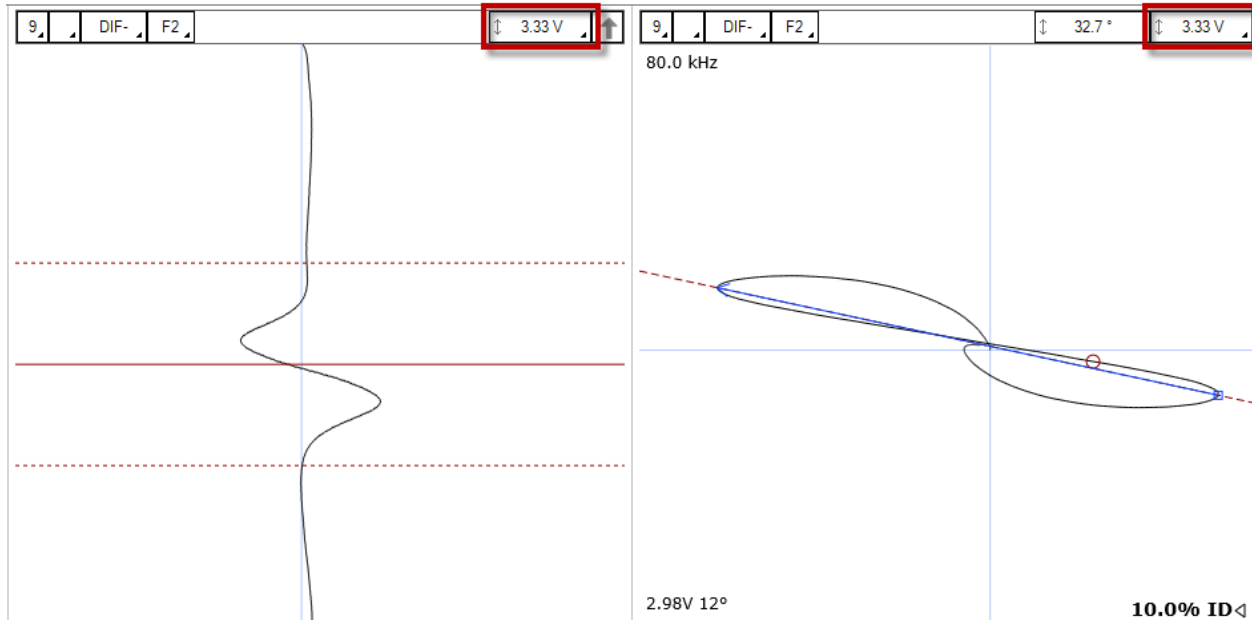

Another way to modify the scale is to click and drag (up or down) the right button of your mouse on the scale button.

## MEASUREMENT METHOD

The buttons at the lower left corner of the Lissajous windows are used to select the measurement method. A short description of the measurement methods can be found in the above calibration section of the setup wizard.



1. Clicking on the corner with the black triangle gives the list of measurement method for the amplitude of the signal. Click on the desired method to select it. Right- or Left-click on this button to select the next or the previous method in the list.
2. Same as 1., but for the phase measurement
3. Remove  $180^\circ$  to the measured phase. This option can be used if the software doesn't measure the phase with the right orientation.
4. Take the same two points in time to take the measurement in the other Lissajous
5. Allow a manual measurement of the signal. Click and drag the left button of your mouse to draw a vector on your Lissajous.

## LISSAJOUS ROTATION AND PANNING

The signal in a Lissajous can be rotated by holding CTRL on the keyboard while holding the left button of your mouse and dragging it around the rotation axis. Note that this operation cannot be performed on the raw channels since these channels have no gain or rotated applied, by definition. Also, rotating the signal will affect your calibration. If you perform this operation, make sure to recalibrate afterwards.

The origin point can also be moved by holding the left button of your mouse on the Lissajous background and by dragging it in the desired direction.

## DATA CENTERING

To center the data in the different windows, put your cursor at a point where you want the data to be centered and use the spacebar on the keyboard.

## CALIBRATION AND SIZING CURVES

### SLEW

The DefHi® probes include two bobbins that generate absolute and differential channels. It also includes a set of pancake coils that generates C-scan(s). Since the bobbins and the pancake coils are not physically located at the same position on the probe, there is a time delay between the channels (coils) and the C-scan (pancakes coils). To bring all the signals at the same position, the bobbin channels can be shifted in time to match the C-scan. This process is called *Slew* in Magnifi.

To Slew:

1. Click on the *Slew* button that can be found under the Calibration tab.

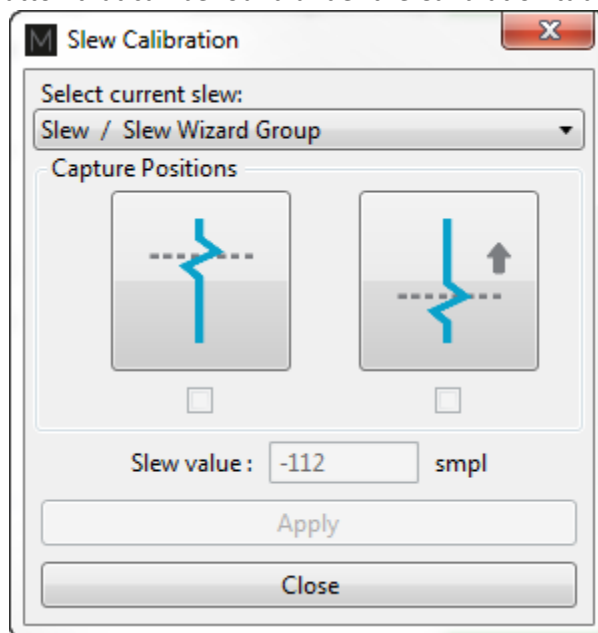

2. Place your cursor over a flaw in your C-scan.
3. Click on the button at the left in the *Slew Calibration* window. This will set the reference point at which the channels will move.
4. Place your cursor over the same flaw but on the differential or absolute channel.
5. Click on the button at the right in the *Slew Calibration* window
6. Click on *Apply*.

Note that this process will move the channels by a constant number of samples. Therefore, a probe pulling speed that was not constant won't have a data alignment that is valid throughout the hole scan.



## CALIBRATION

The following section describes how to calibrate your probe.

1. Go to the *Calibration* tab and click on the *System* icon
2. Select Channel in the calibration window
3. In the Strip chart, select the signal to calibrate and adjust the cursors to see only the desired signal.

Note: The system calibrates the signal with a measurement method that is defined in the calibration part of the setup (previous step). It is recommended to read the data with the same method as the system when you select your calibration point. This will allow you to see what the system is using to make its calibration. If, for some reason, the measurement is not taken properly, you may be able to readjust your cursor to have the right measured values.

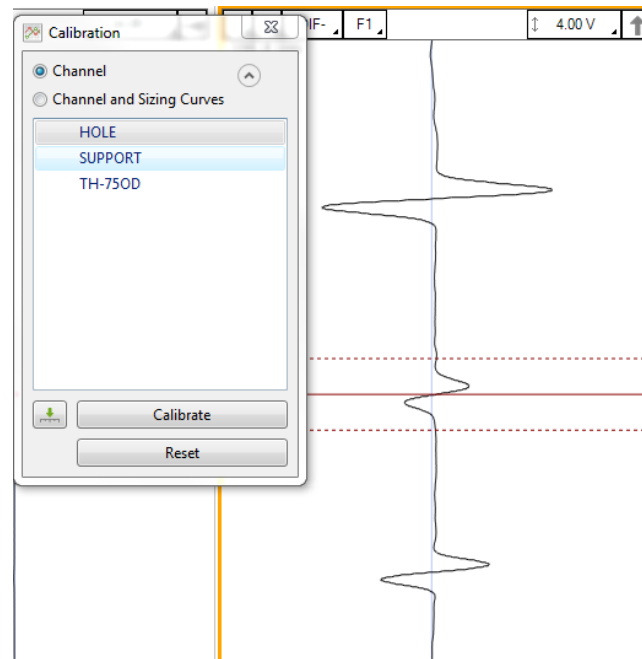

1. Select the signal name in the list.
2. Click on the green arrow button to associate the measured signal to the calibration point.
3. If more than one calibration point is present in the list, repeat step 3, 4 and 5 for each one.
4. When all your calibration points are check-marked, click on the *Calibrate* button

## SIZING CURVES

The following section describes how to build your sizing curves.

1. Go the calibration tab and click on the Sizing curve button.
2. Select *Channel and Sizing Curves*/or *C-Scan and Sizing Curves* in the calibration window.
3. Select the signal in your Strip chart/ or C-scan and adjust the cursors to see only the desired signal.

Note: The system calibrates the signal with a measurement method that is defined in the calibration part of the setup (previous step). It is recommended to read the data with the same method as the system when you select your calibration point. This will allow you to see what the system is using to make its calibration. If for some reason the measurement is not taken properly, you may be able to readjust your cursor to have the right measured values.

Also, when points are entered in the sizing curves, the interpolated value is displayed on the Lissajous to show the defect size. To have the correct interpolated point, the measurement method also needs to be the same as the one used for the sizing curve. To change the measurement method, click on the icons at the bottom left of the Lissajous.

1. Select the signal name in the list.
2. Click on the green arrow.
3. Redo the previous steps for all the other indications in the list.
4. Click on the Calibrate button.

The previous operations must be done for the channels and the C-scans.

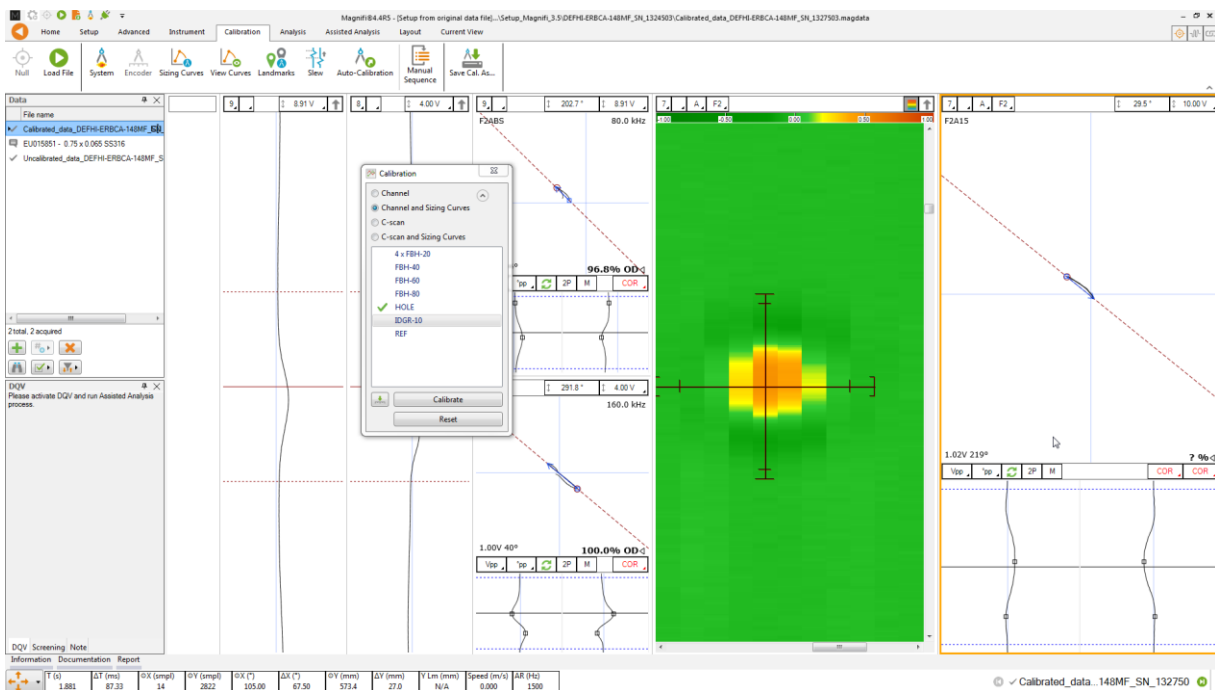

Error messages after creating the phase sizing curves may appear. The main cause of these errors is the measurement direction.

The image below shows two different measurements. On the left, you can see that the measurement arrow is pointing towards the liftoff signal. In this case, the measured phase is rotated of 180° from the right value. When one or more points were measured in the wrong direction, Magnifi cannot build the sizing curve and will generate an error message.

In the image on the right, the arrow is pointing from the liftoff signal to the defect signal, which is correct. However, in this picture, the arrow starts quite far from the middle of the liftoff variation signal, which will cause an error in the measurement. In this case, we suggest you move the cursors until your measurement is taken from a point near the base of the signal.

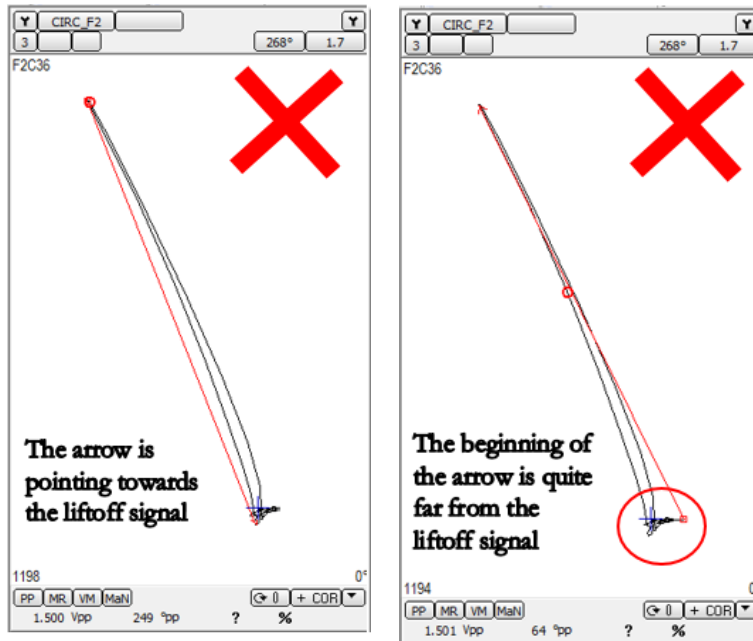

To adjust your sizing curves and remove the error messages, go the *Calibration* tab, and click on *View Curves*.

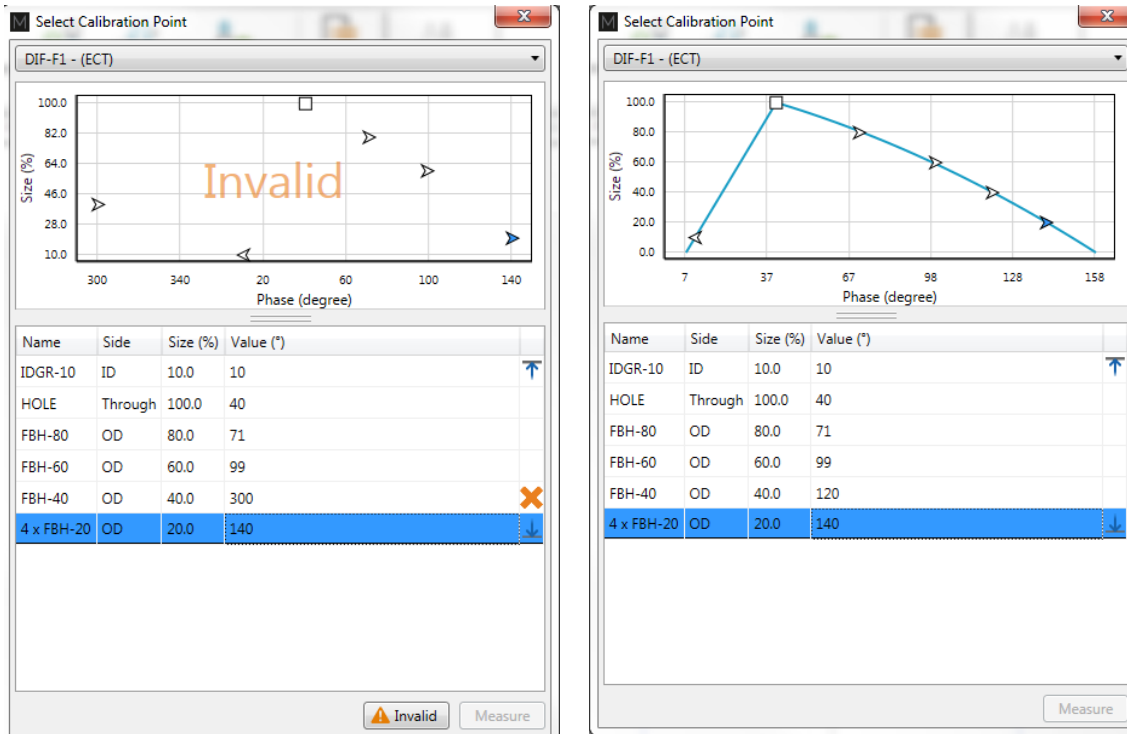

The sizing curve window will appear. Each sizing curve you asked Magnify to create will be listed in the drop-down menu. If an invalid notification is present on the curve, it means that you either haven't entered the sizing points yet, or that Magnifi failed to create the curve. To adjust the sizing curve manually, enter the value in the table.

In the above example, the entered phase angle for the 40% defect is 300°, but the correct phase angle for the 40% defect is 120°. The 40% defect has 180° bias due to an incorrect measurement direction. In this case, we can simply change the angle value from 300° to 120° in the table to fix the sizing curve.

To validate the curves, you can bring the measurement cursor over one of the calibrated flaws in the Lissajous and get an estimation of the depth (shown in the lower right corner). If the flaw size does not appear, it means that you are not in a channel where a sizing curve was set.

## LANDMARKS

The following section describes how to calibrate your landmarks.

Go to the calibration tab and click on the Landmark icon. Calibrate the landmarks shown in the *Landmarks* window the same way you calibrate the sizing curve(s) points. You can use the *Land* channel to do so. The positions of TS1 and TS2 are described in the *Landmark* window in the *Setup* tab (TS2 is the far side tubesheet, that is, the first one encountered by the probe during data acquisition; TS1 is the nearside tubesheet).

Once the landmarks are calibrated properly, the system should be able to recognize them automatically.

Note that in order to calibrate the default *Exit* landmark, a datafile that includes the probe exit at the far end of the tube is needed.

## SAVING YOUR SETUP

Once all your setup adjustments are done, you can save your setup by clicking on the *Save Setup* button under the *Home* tab. The displayed window will allow you to give an appropriate name to your setup and to save it at the desired locations. The save location is, by default, your inspection file. Note that when data is saved, the setup is also saved with it.

You can also save the data of your calibration standard by clicking on the *Save As* button under the *Home* tab.

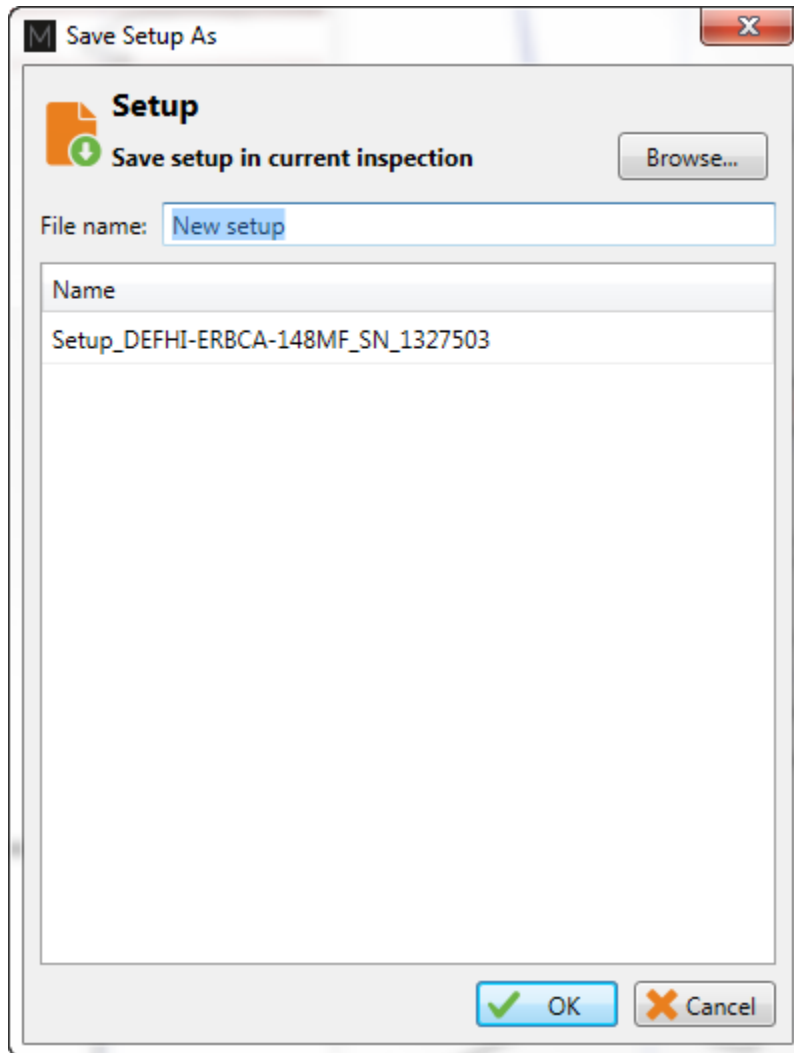

### STANDARD ACQUISITION

The following section describes how to perform an inspection.

1. Connect Magnifi to the instrument
2. Enter into *Acquisition Mode* by clicking on the *Setup Mode* button under the *Home* tab. *Acquisition Mode* is activated when the *Setup Mode* button is not grayed.
3. Plug the DefHi® probe into the Ectane 160-pin connector. The orange dot on the connector must be aligned with the orange dot on the Ectane.
4. Bring the probe head to a clear area in your standard and balance the probe by clicking on the *Null* button under the *Home* tab, or press F6 on your keyboard.
5. Push the probe all the way through the tube until it exits the far end.
6. Start the acquisition by clicking on the *Acquire* button under the *Home* tab or by pressing the F2 on your keyboard.
7. Pull the tube towards you at a constant speed (approximately 12"/s or 300 mm/s) until it exits the tube.
8. When finished, press the *Stop* button or again F2 on your keyboard.
9. Repeat steps 4,5 and 6 for all the tubes to inspect in your bundle.

### MANUAL SEQUENCE

An inspection can also be done by using the manual sequence. This feature is based on the landmarks and can trigger the acquisition start/stop and the data recording automatically. At least two landmarks are needed to use this feature. These landmarks can be created by using the Landmarks button under the SMART Setup tab.

To set the manual sequence:

1. Click on the *Manual Sequence* button under the *Calibration* tab.
2. If a warning message is shown in this window, change the parameters until no warning are shown. The system will progress through the different windows to guide you.
3. Click on *Settings ...*

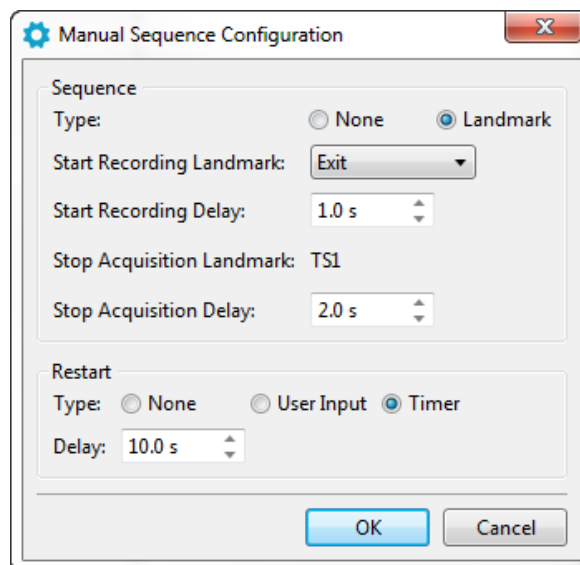
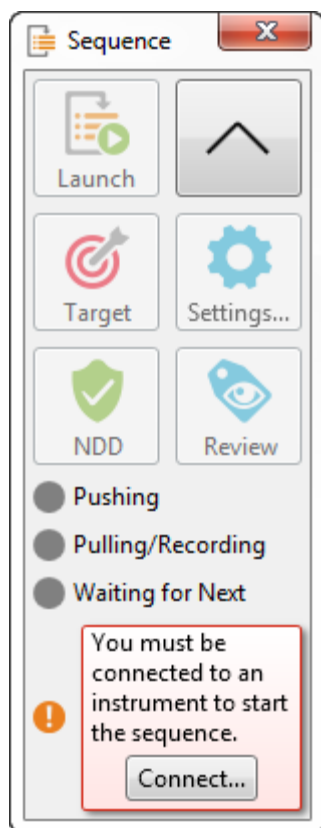

4. Select *Landmark* in the *Type* section
5. In the drop-down menu choose the Landmark that will initiate the data recording. If you keep the default landmarks, you can select the *Exit* landmark that will be triggered when the probe goes out of the tube when the probe is pushed.
6. You can enter a delay to start the acquisition after the first landmark is detected (*Start Recording Delay*) and a delay to stop the acquisition when the last landmark is detected (*Stop Acquisition Delay*).
7. Two options are available to restart the acquisition: The user can either push a button or use a timer. Select the desired option in the *Restart* section.
8. Click on *OK*.

To use the manual sequence:

1. Connect Magnifi to the instrument
2. Enter into *Acquisition Mode* by clicking on the *Setup Mode* button under the *Home* tab. *Acquisition Mode* is activated when the *Setup Mode* button is not grayed.
3. Plug the DefHi® probe into the Ectane 160-pin connector.
4. Bring the probe head in a clear area in your standard and balance the probe by clicking on the *Null* button under the *Home* tab, or press F6 on your keyboard.
5. Open the *Sequence* window by clicking on the *Manual Sequence* button under the *Calibration* tab
6. Put your probe in the tube to inspect and click on the *Launch* button. This will start the data acquisition.

7. Push the probe until it exits the far end of the tube. If set correctly, Magnifi will recognize the landmark and this will initiate the data recording.
8. Pull the probe towards you until it exits the tube. This will trigger the last landmark detection that will stop the data recording.
9. Acquisition restart:
  - a. If you selected *User Input* in the settings of the *Manual Sequence Configuration*, the system will wait for the user to enter information on the tube to restart the acquisition. Click on *NDD* or *Review*. This will add a tag to the inspected tube and it will restart the acquisition. Repeat steps 6, 7 and 8. for all the tubes to inspect
  - b. If you selected *Timer* in the settings of the *Manual Sequence Configuration*, a countdown will trigger after the last tube acquisition was taken. The acquisition will start after this time has elapsed. Redo step 6 and 7 for all the other tubes to inspect in the bundle.

When doing your inspection, you may encounter some tubes that can't be scanned completely. If this is the case, you won't be able to catch the landmark that triggers the data acquisition at the end of the tube. In this situation, you can click on the *Target* button in the *Sequence* window to start the data recording.



## DATA LIST MANAGEMENT

For each acquisition, Magnifi can automatically save a file using the file name defined previously in the *Tube list* section of this document. To do so, checkmark the *Automatic File Recording* option that can be found under the *General tab* of the *Preference* menu of the *Backstage*.

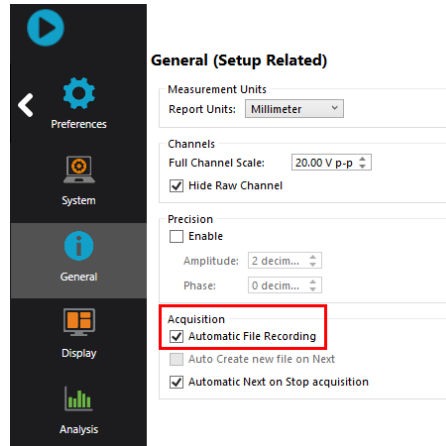

The list of tubes is also shown in the *Data* window.

The Data window shows a list of 22 tubes. The first 10 tubes have a checkmark icon, and the last 5 tubes have a play icon. The table below represents the data shown in the window:

Row	Col	Status
✓	10100001	20 (8)
✓	10100002	9 (8)
✓	10100003	10 (8)
✓	101001001	16 (8)
✓	101001002	9 (8)
✓	101002001	11 (8)
✓	101002010	14 (8)
✓	101004005	15 (8)

A common practice is to rescan your calibration tube and balance the probe periodically. You can save this new calibration tube data by adding a new tube in your tube list (999 001 for example). Or you can go out of acquisition mode, scan your tube, and click on the *Save Cal As...* button under the *Calibration* tab to save your data. You can then go back to *acquisition mode* to continue your inspection and to automatically save the acquired tubes in your bundle.

Once a tube has been scanned, the "play" icon next to the file name will be replaced with a checkmark icon.

You can rescan a tube by selecting its name in the list and by clicking on the *Rescan* button in the *Home* tab.

A tube name can be changed by right-clicking on its name and by selecting the *Rename* option.

## LOADING A FILE

1. First disconnect your computer from the Ectane by clicking on the *Disconnect* button under the *Home* tab.
2. You can load a file by double-clicking on the file name in the *Data* window. It can also be done by selecting the file in the list and by clicking on the *Load* button under the *Home* tab. Note that double-clicking on a tube when you are still connected to an instrument will initiate data acquisition.
3. You can open the next or the previous file in the list by clicking on the *Previous* or *Next* button of the *Home* tab.

The data files can be filtered by using the *Filter* button of the *Data* window.

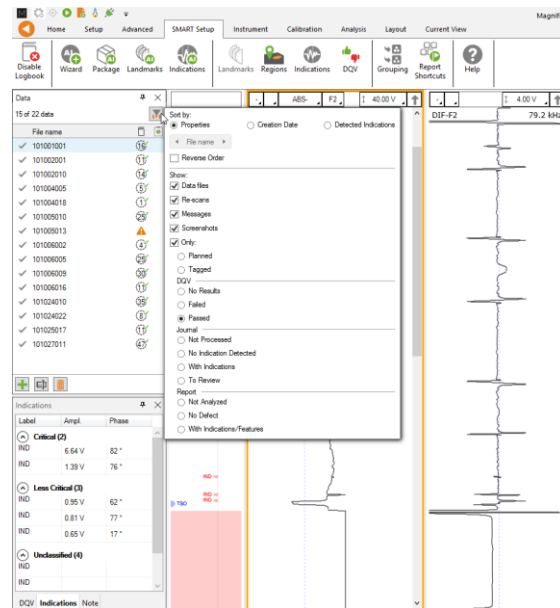

## REPORT

### INDICATIONS

The two *Indication* buttons at the lower corner of the Lissajous windows can be used to add an entry to the report. These two buttons indicate the code that is associated with the defect being entered. Both buttons are identical, but can be set to identify different flaws.

To add an indication to the data:

1. Select the defect signal in the strip chart and adjust the cursor so that the signal in the Lissajous includes only the defect signal.
2. Then, click on the red triangle in the corner of the *Indication* button to select the type of defect to enter.
3. Click on the defect button to add an entry to the report.

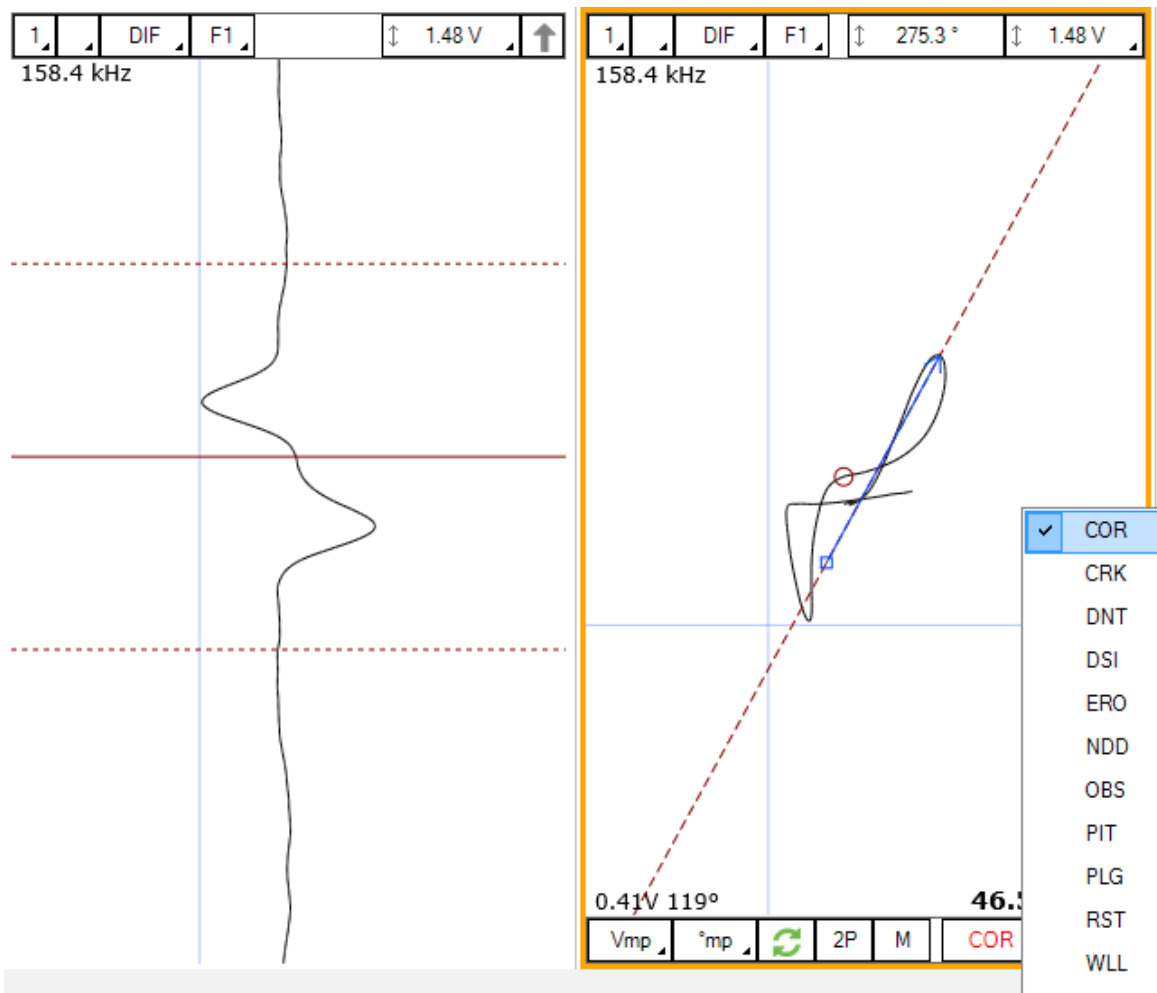

Report Entries can also be added with keyboard shortcuts. How to set up these keyboard shortcuts is explained in the SMART Setup section of this manual.

Indications can also be added to a tube to indicate, for instance, that it has no flaw or that it is plugged.

To add an indication to a tube:

1. Load the file
2. Click on the appropriate indication button available under the Analysis tab.

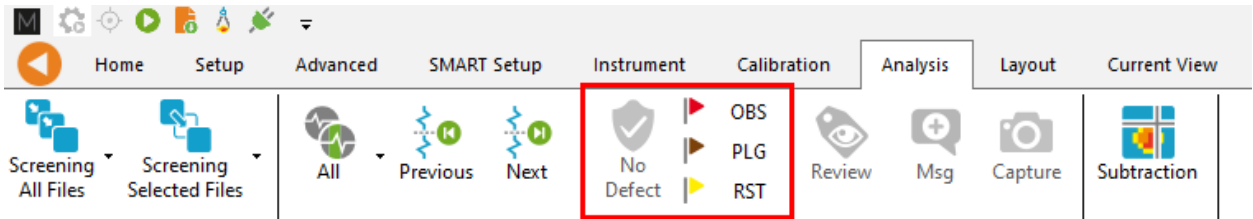

## REPORT TABLE

To access the list of indications entered:

1. Make sure that the Report option is selected under the Layout tab.

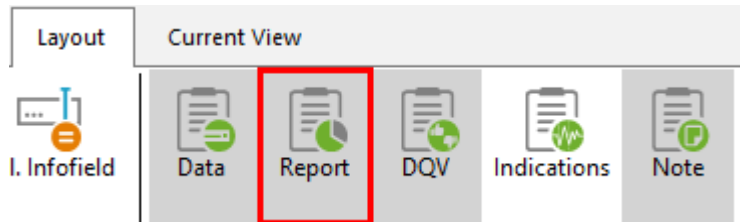

2. Click on the report ribbon at the bottom of the screen to make the list visible

Zone	Row	Col.	Code	Size	Side	Ampl. (V)	Angle (°)	Channel/C-scan	Y pos. (mm)	LMK Y pos.	Offset Y pos. (mm)	Y leng. (mm)	Comment
1	0	0		0.00		0.00	0		0.0		0.0	0.0	
2	0	0		0.00		0.00	0		0.0		0.0	0.0	

Entries in the report can be modified by changing the value in the table. You can also delete an entry by clicking on the X next to it.

## REPORT GENERATION

Magnifi can automatically generate a full report with the report table.

To generate this report:

1. Go to the *Backstage* by clicking on the arrow at the upper left corner of the *Frontstage*.
2. Click on the *Generate Report* button under the *Report* section of the *General* tab.
3. Choose your preferences and enter the required parameters. The *# of tubes in component* is used to show the percentage of tube in each category.

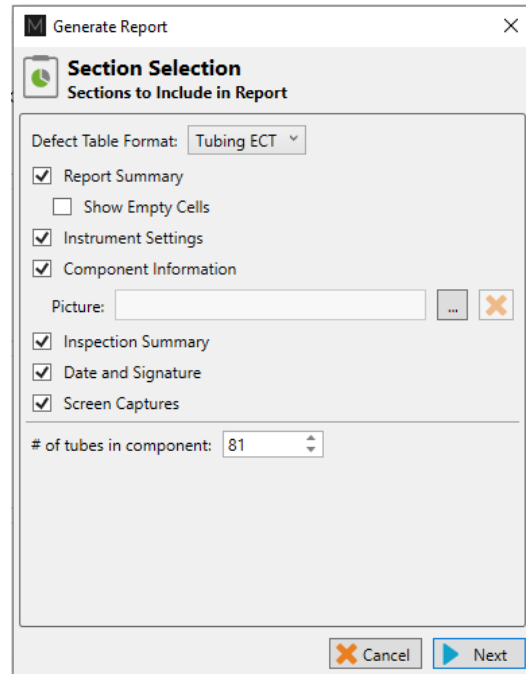
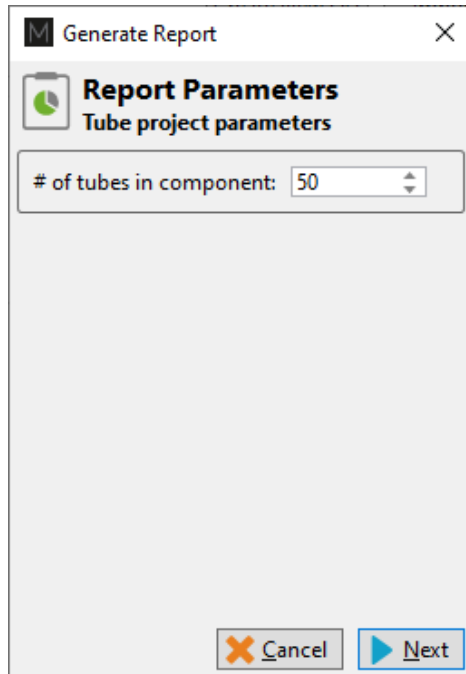

4. Click Finish to generate the report.

Once generated, the report is saved as a .html file in the current Inspection sub-directory. It can be viewed using any regular web browser.

There is a “copy” button next to each element of the report such as tables and images. When clicking on it, the element will be copied to the clipboard. It can then be pasted to another file such as an Excel or Word.

Name	Frequency (KHz)	Drive (V)	Gain (dB)	Low Pass (KHz)	High Pass (Cut)
R_ABS-F1	160.0	2.50	46.0	400	
R_ABS-F2	80.0	2.50	46.0	400	
R_ABS-F3	40.0	2.50	46.0	400	
R_ABS-F4	20.0	2.50	46.0	400	
R_DIF-F1	160.0	2.50	46.0	400	
R_DIF-F2	80.0	2.50	46.0	400	
R_DIF-F3	40.0	2.50	46.0	400	
R_DIF-F4	20.0	2.50	46.0	400	

The Print button, bottom right corner on image above, can be used to either print a paper copy of the whole report or to save it as a .pdf document. The PDF generator available with the current web browser will be used.

10/10/2023 15:31 Magnifi Report

**Analysis Report**

Instrument Settings  
Setup name: ECT\_Bobbin

Channels

Name	Frequency (kHz)	Drive (V)	Gain (dB)	Low Pass (kHz)	High Pass (kHz)
R_ABS-F1	160.0	2.50	45.0	400	
R_ABS-F2	80.0	2.50	45.0	400	
R_ABS-F3	40.0	2.50	45.0	400	
R_ABS-F4	20.0	2.50	45.0	400	
R_DIF-F1	160.0	2.50	45.0	400	
R_DIF-F2	80.0	2.50	45.0	400	
R_DIF-F3	40.0	2.50	45.0	400	
R_DIF-F4	20.0	2.50	45.0	400	

Imprimer 4 pages

Destination Enregistrer au format f

Pages Tous

Mise en page Portrait

Plus de paramètres

Enregistrer Annuler

The report logo can be modified by clicking on the *Select Company Logo* that can be found under the *System* tab of the *Backstage*.

**System (Computer Related)**

Measurement Convention  
 ASME  
 ASME Inverted  
 EDF

Measurement Units  
 Metric  
 Imperial

Readback  
 Do not display data during loading  
 Speed:  
 Actual Inspection Speed  
 Maximum  
 "Keep Current Setup" Button Behavior:  
 Retain check state  
 Reset to checked after loading a data file  
 Setup Wizard Path: C:\Users\daube.QTEC\Documents\Magnifi\Setup

Automatic Features  
 Allow to save setup in original location  
 Ask to save setup when the first data file is recorded

Logo  
 Select Company Logo Preview: eddyfi

The report table file in the *Inspection* folder can also be imported into other reporting software such as *TubePro*.

# RFT Application Guide

RFT Single-Driver Probes



RFT Single-Driver Boiler Probes



RFT Double-Driver Probes



RFT Single-Driver Flexible Probes





## INTRODUCTION

This document presents how to use an RFT probe with Magnifi 5 on an Ectane test instrument.

Eddyfi offers four types of RFT probes. The following was made using a dual-driver probe (RFT-DDST) but can also be applied to all other types of RFT probes.

## EQUIPMENT

The RFT probes use a 19-pin connector that can be connected to an Ectane with the “ERNM” option. The absolute and differential signal from the probe will provide Strip charts, Lissajous and Voltage planes.

A wide range of probe diameters are offered (see the tubing probe catalog for more details). A wide range of frequencies are also available to allow inspections of tubes of different thickness and material.

From the following table, the best probe for your application can be selected.

Table 8 – RFT-DDST probes diameter selection table

TUBE OUTSIDE DIAMETER	TUBE WALL THICKNESS (BWG, mm, in)																
	BWG	4	5	6	7	8	9	10	11	12	13	14	15	16	17	18	
	mm	6.05	5.59	5.16	4.57	4.19	3.76	3.40	3.05	2.77	2.41	2.11	1.83	1.65	1.47	1.24	
	in	0.238	0.220	0.206	0.180	0.165	0.148	0.135	0.120	0.109	0.095	0.083	0.072	0.065	0.058	0.049	
15.87 mm	0.625 in	–	–	–	–	–	–	–	–	–	100	100	110	110	110	120	
19.05 mm	0.750 in	–	–	–	–	–	100	110	110	120	120	130	130	140	140	140	
22.22 mm	0.875 in	–	100	100	110	120	130	130	140	140	150	160	160	170	170	170	
25.40 mm	1.000 in	120	120	130	140	150	150	160	170	170	180	180	190	190	190	200	
31.75 mm	1.250 in	180	180	180	200	200	200	220	220	220	240	240	240	240	240	260	
38.10 mm	1.500 in	220	240	240	260	260	260	280	280	280	280	300	300	300	300	300	
50.80 mm	2.000 in	340	360	360	380	380	380	400	400	400	420	420	420	420	420	440	

Table 9 – RFT-DDST probe frequency range selection table

MATERIAL	TUBE WALL THICKNESS (BWG, mm, in)																
	BWG	4	5	6	7	8	9	10	11	12	13	14	15	16	17	18	
	mm	6.05	5.59	5.16	4.57	4.19	3.76	3.40	3.05	2.77	2.41	2.11	1.83	1.65	1.47	1.24	
	in	0.238	0.220	0.206	0.180	0.165	0.148	0.135	0.120	0.109	0.095	0.083	0.072	0.065	0.058	0.049	
Carbon steel A178, A179, A192, A214		LF	LF	LF	LF	MF	MF	MF	MF	MF	MF	MF	MF	MF	MF	MF	
Cast iron (gray)		MF	MF	MF	MF	MF	MF	MF	MF	MF	MF	MF	HF	HF	HF	HF	
Ductile iron		LF	LF	LF	MF	MF	MF	MF	MF	MF	MF	MF	MF	MF	MF	HF	
Nickel 200		MF	MF	MF	MF	MF	MF	MF	MF	MF	MF	MF	MF	MF	MF	HF	
Stainless steel 439, A268, TP439		MF	MF	MF	HF	HF	HF	HF	HF	HF	HF	HF	HF	HF	HF	HF	
Stainless steel duplex (2205), 3RE60, A789		HF	HF	HF	HF	HF	HF	HF	HF	HF	HF	HF	HF	HF	HF	HF	

Table 10 – RFT-DDST Frequency range

CODE	FREQUENCY IN Hz		
	Min.	Max.	Central
LF	10	400	50
MF*	50	2000	300
HF	500	20 000	2 500

\* Standard frequency range

The RFT calibration tube used in this document includes the following indications:

- External groove, 40% and 60% of wall loss
- Hole, 100% of wall loss
- OD Flat Bottom Hole (FBH), 60% depth
- OD 4 x FBH, 20% depth
- A support plate

Other combinations can be used to calibrate the probe and to build sizing curves.

*Note: Fill factor and selection tables may differ for other types of RFT probes. Please refer to the tubing probe catalog on our website to find out more.*

## PROJECT AND INSPECTION FILES

---

In this section, we will create a folder structure that will manage the saving location of your setup, data and report. This management is operated through the creation of a *Project*.

Magnifi suggests two levels of files. The first level is the *Project*. It is meant to include different inspections that are related in some way. For instance, it can include all the inspections done at a refinery shutdown and be named *Refinery\_Shutdown\_May\_2018*. The second level of file is the *Inspection* folder. Inspection folders are saved in the project file. An inspection folder can include the data specific to the inspection of a tube bundle with a specific technology and could be named *CS\_075x0.083\_RFT*, for instance. This inspection folder groups the setup, the tube list, the data files and the Magnifi report.

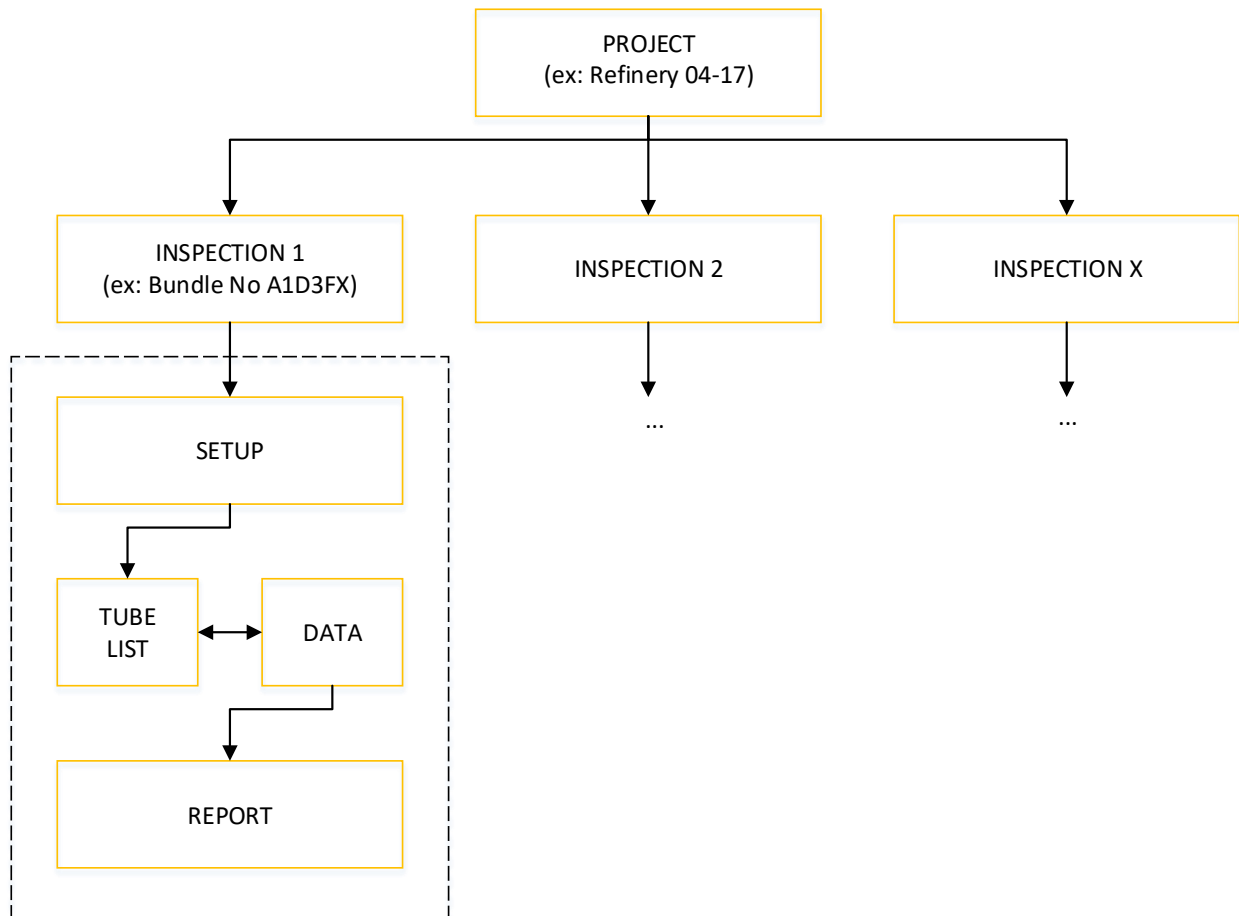

When you open Magnifi, the first page displayed is called the *Backstage*.

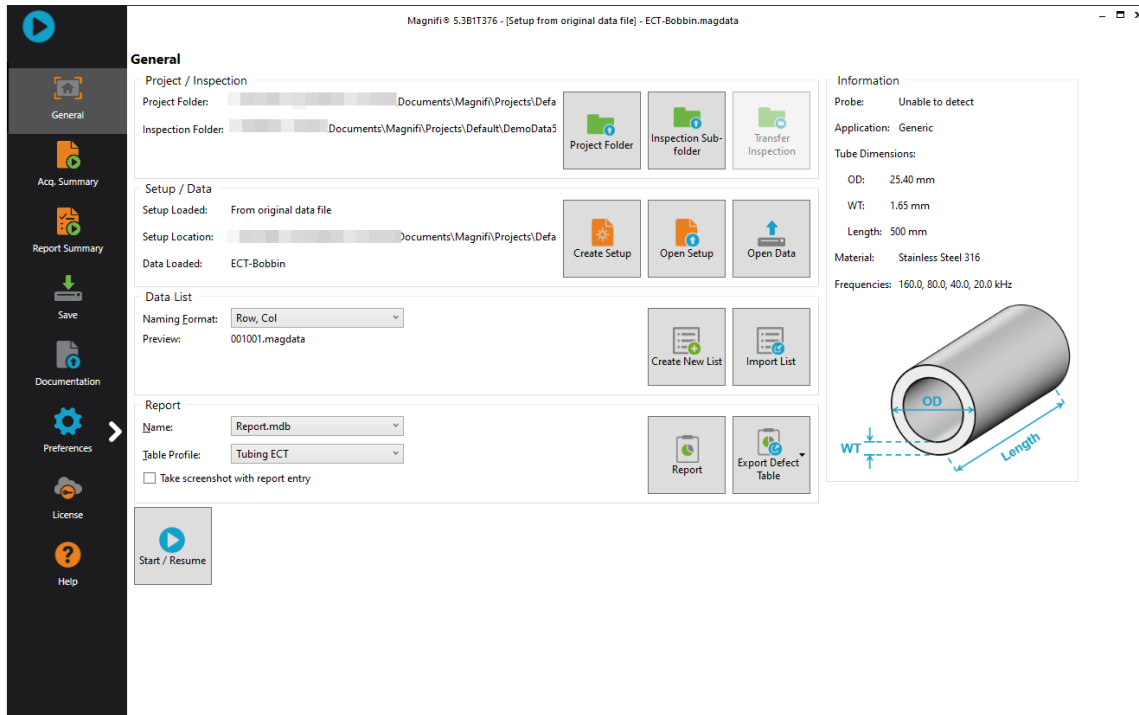

To create or open a project, click on *Open/Add Project* in the backstage. You can select an existing project/folder or you can create a new folder.

1. Create a folder by right-clicking on the location where you want to add your project file. Select *New, Folder* and enter the chosen name. You can then select the newly created folder and click on *Select Folder*.

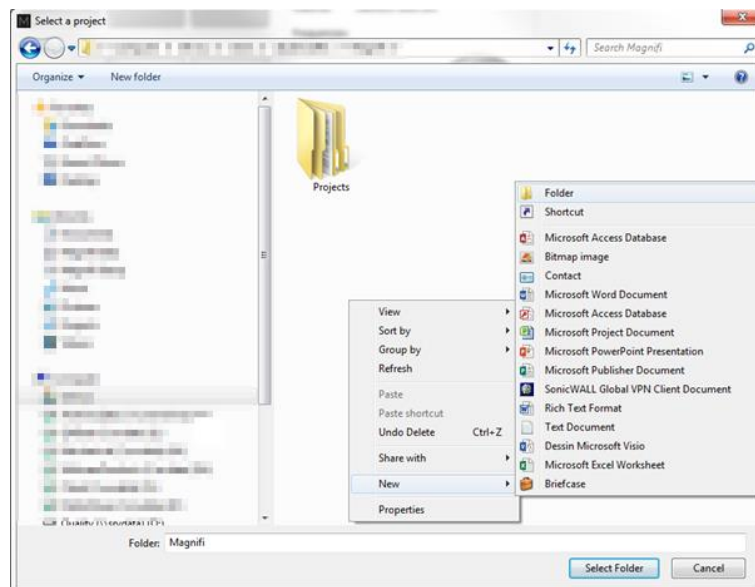

2. Click on *Add/Open Inspection* in the backstage, then click on *Add* and enter the name of your inspection.

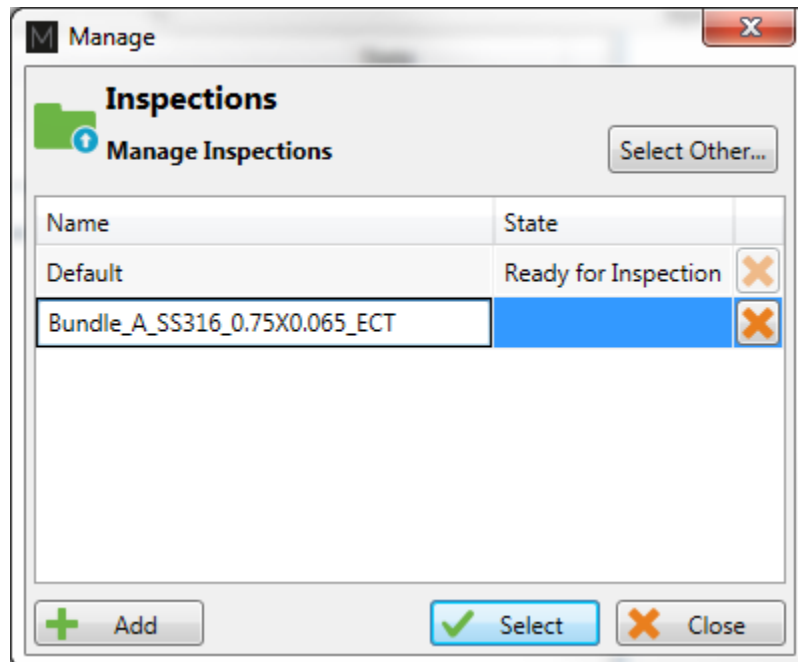

3. Click *Select*. This will define the position where the setup(s) and data will be saved.

## SETUP WIZARD

In this section, we will show how to create a setup using the *Setup Wizard* in Magnifi.

Before going further, you can change the measurement unit. To do so, click on *Preferences*. In the *System* tab, you can change the measurement units from metric to imperial and vice versa. For the metric units, you can choose to use meters, centimeters, or millimeters in the *General* tab. The default measurement for imperial units is inches. When finished, click on *Preferences* again to go back to the *General* window.

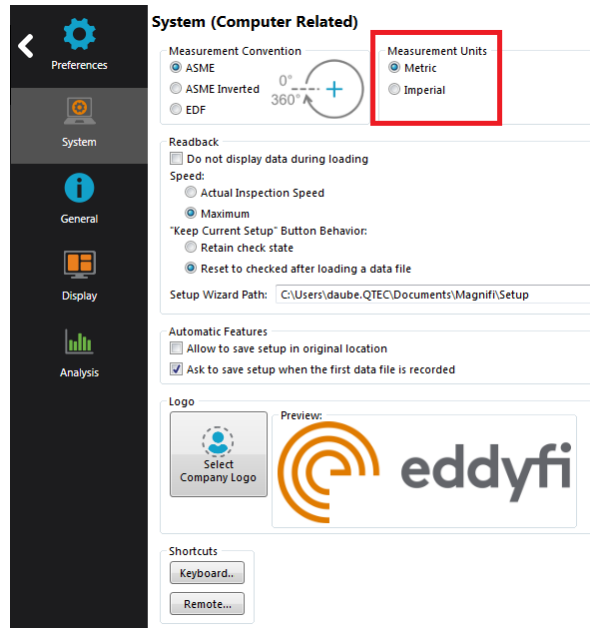

To create a new setup, it's strongly suggested to use the *Setup Wizard* process. Click on *Create Setup* to start the *Setup Wizard*.

## COMPONENT DEFINITION

The first page shown by the Setup Wizard is the Component Definition.

Click on the Material field to open the drop-down menu. Select the material of the tube to be inspected. If the material is not in the list, you can click on Manage... to open the List of Available Material window.

**New Setup Wizard** ×

**Component Definition**

Configure the geometry and material of the component to inspect

Geometry:  Surface  Tube from ID

Application:  Generic  Air Conditioner

Material: Carbon steel

Resistivity: 21  $\mu\Omega\cdot\text{cm}$

Permeability: 450  $\mu$

Velocity: 5890.000 m/s

Wall thickness: 1.65 mm

16 6 24 BWG

Outside diameter: 19.05 mm

Length: 6000 mm

Note about selected material:  
ASTM: A178, A179, A192, A210, A214

To add a new material to the list, click on *Add*. A new line will appear in the list. Give the material a relevant name and set the material resistivity and permeability to its theoretical value. The ultrasound velocity is used to set IRIS parameters only, and it doesn't need to be set if an IRIS inspection is not performed on this material.

It's possible to add a note about the material to specify information such as its application or composition. When you are done, click *OK*.

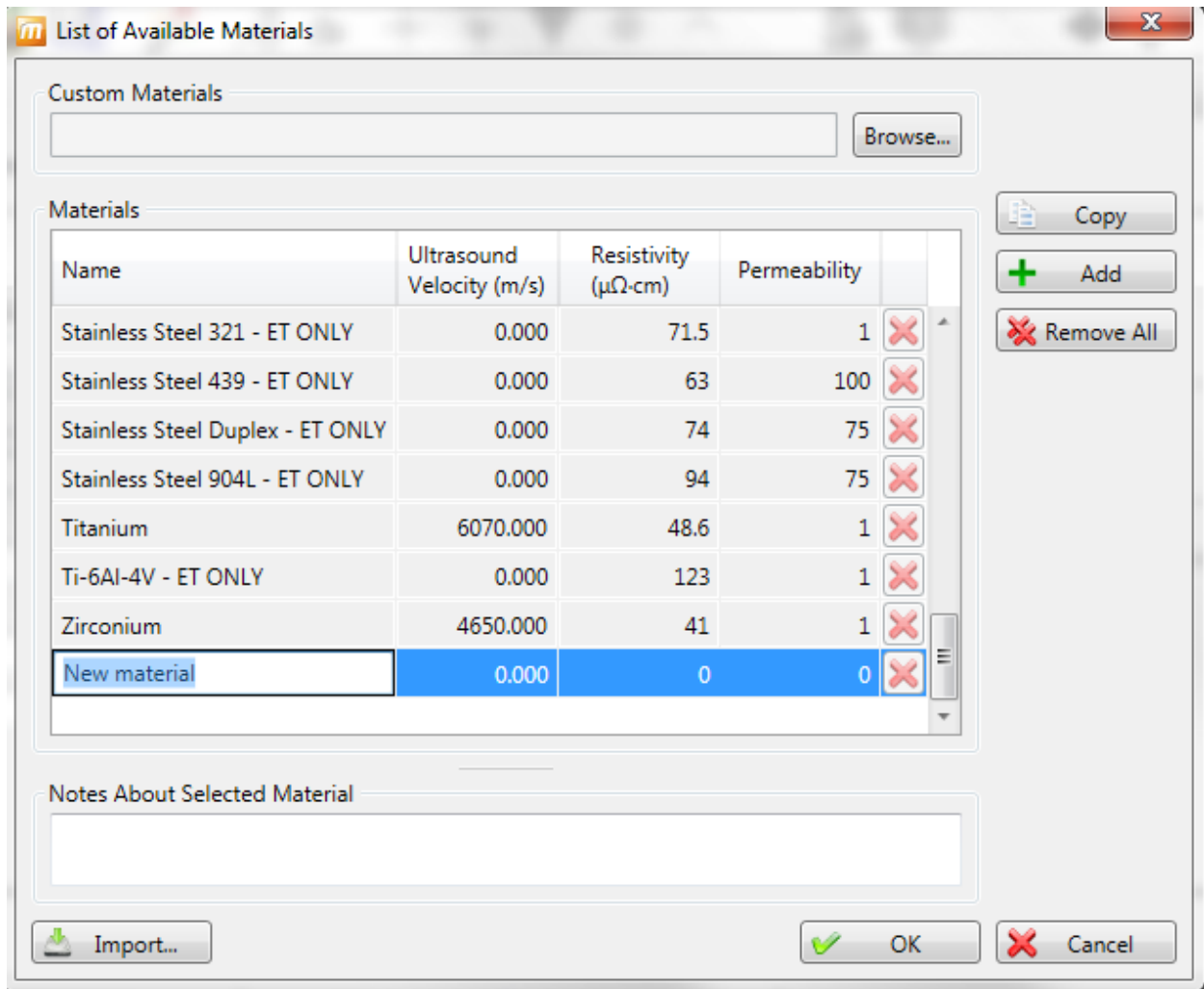

You will be back to the *Component Definition* window. If you added a new material, it will now be available in the material list.

Adjust the tube wall thickness by entering the value in the *Wall thickness* field or by moving the slider. Enter the tube's outer diameter and length.

These tube properties will help Magnify to suggest the optimal scan parameters.

Click *Next* when everything is set correctly.



## PROBE SELECTION

In the *Probe Selection* window, select the probe you will be using for your inspection.

You can filter the probe list by choosing an inspection technique from the *Technique* drop-down menu. More precise filtering can be done by using the *Model* drop-down menu. You can then select your probe by its catalog number (PRBT-RFT-DDST) and then click *Next*.

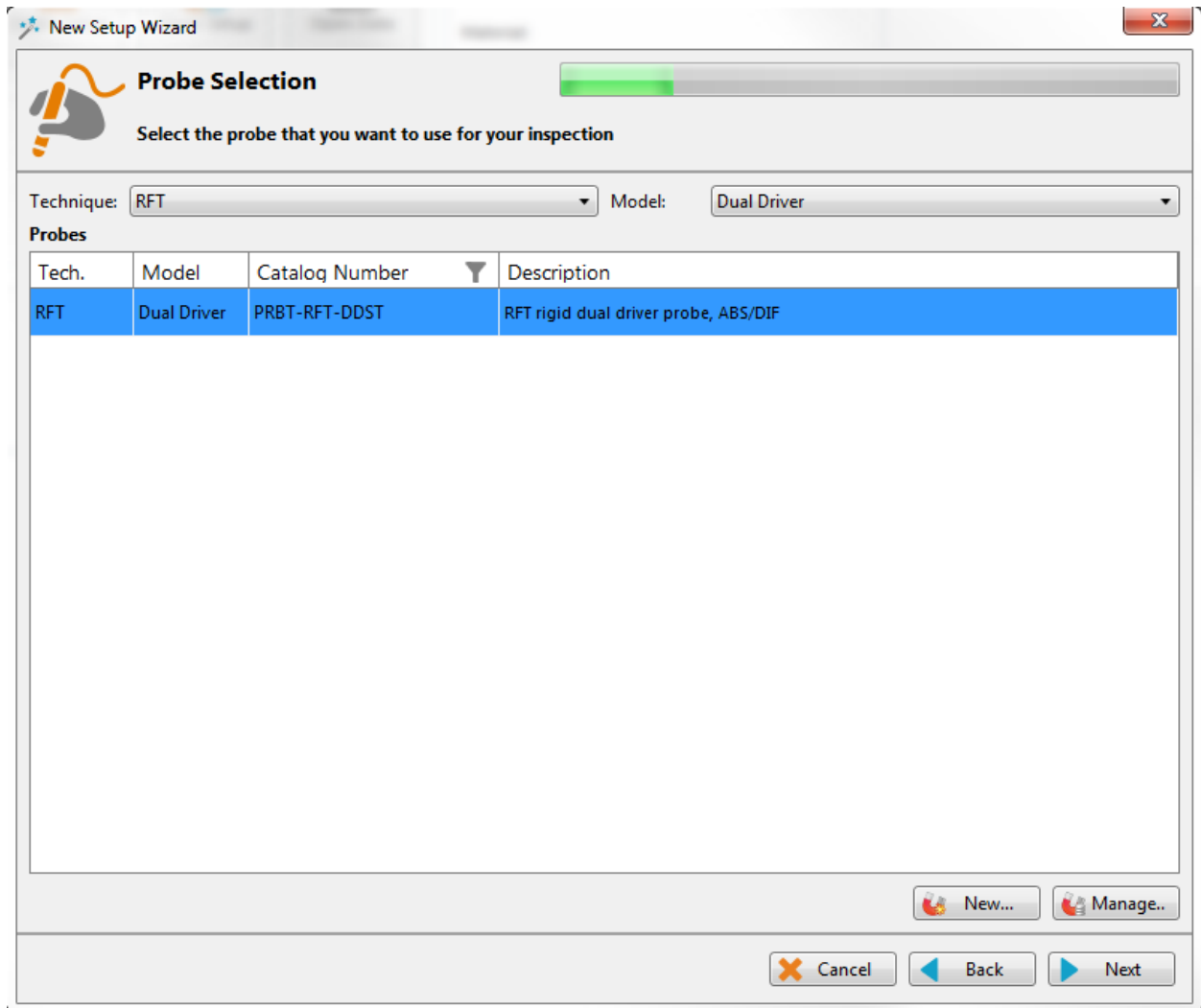

## SCAN DEFINITION

The *Scan Definition* window is used to configure the axial position measurement method, the acquisition rate and the typical probe speed.

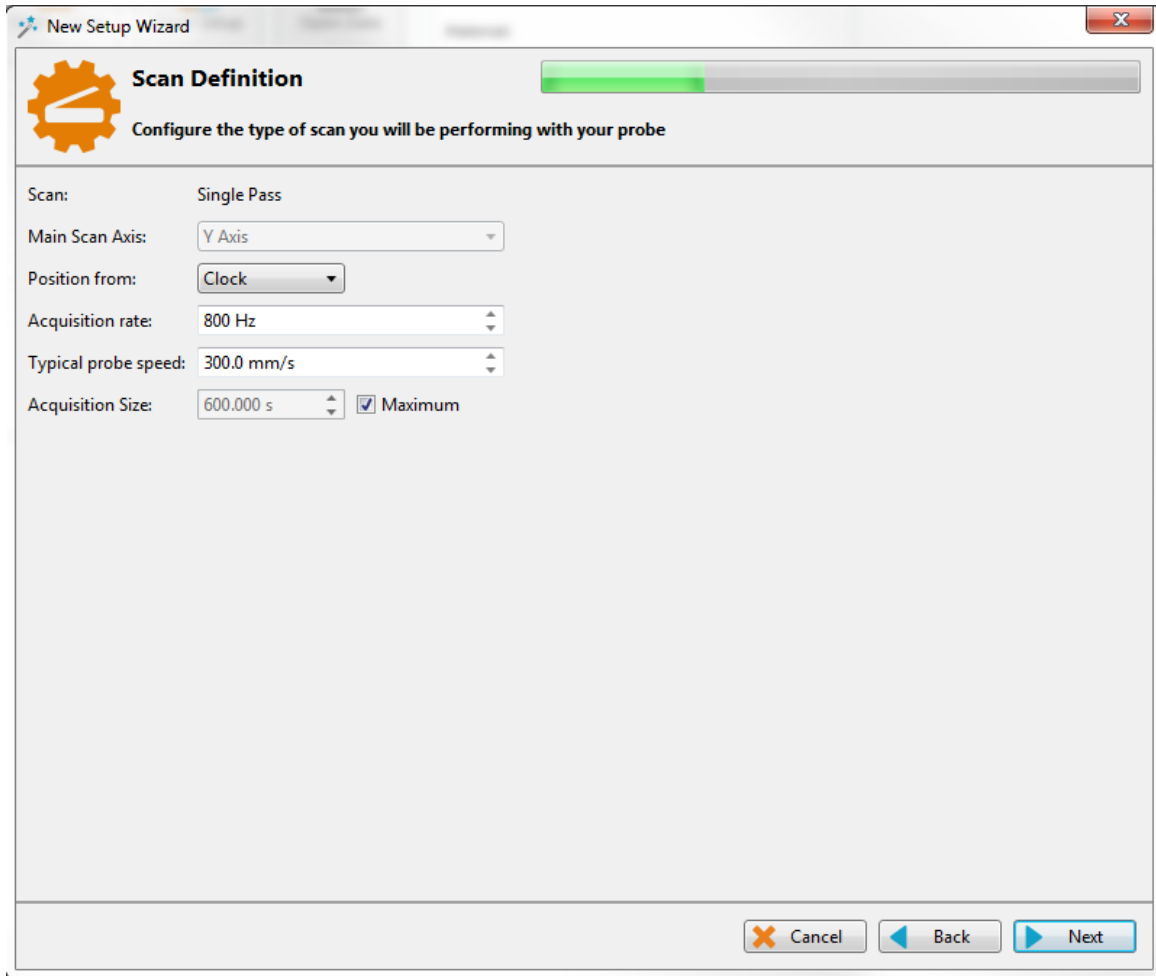

The position along the tube can be defined by using either the internal clock of the system, or by using an axial encoder. If you use the internal clock, the default position will be given assuming that the probe is always pulled at the typical probe speed. If the typical probe speed is set to 200mm/s, and the time since the acquisition began started is 2 seconds, then the system will indicate a position of 400mm. Using an encoder will give you the exact position of the probe. Note that the position can also be obtained by using the landmark tool, but this feature will be shown later.

The acquisition rate is the number of acquisition points taken per second. By default, the acquisition rate is set to 800 Hz for RFT, but depending on the drive frequency used to inspect, the actual acquisition rate may differ. The system will automatically readjust this value if needed.

The axial resolution will depend on the combination of the acquisition rate and pulling speed. For an acquisition rate of 800 Hz, the pulling speed needs to be less than 400mm/s to have at least 2 points per millimeter. If you do not use a pusher-puller device such as Probot, the pulling speed won't be constant.

Therefore, it is recommended to target a lower pulling speed to be able to reach your axial resolution target. The typical probe speed should be set as close as possible to the real value. This will help the algorithm that automatically detects landmarks (this will be explained in the Landmark section). The recommended pulling speed for RFT depends on the excitation frequency (set in the next step) and is shown in the table below:

Excitation Frequency (Hz)		Maximum pulling speed (in/s)
Maximum	Minimum	
20	100	4
100	200	6
200	350	8
350	500	10
500	1000	12
1000	-	20

If you selected to measure the position from Encoder, different fields will appear and a second *Scan Definition* page will become available.

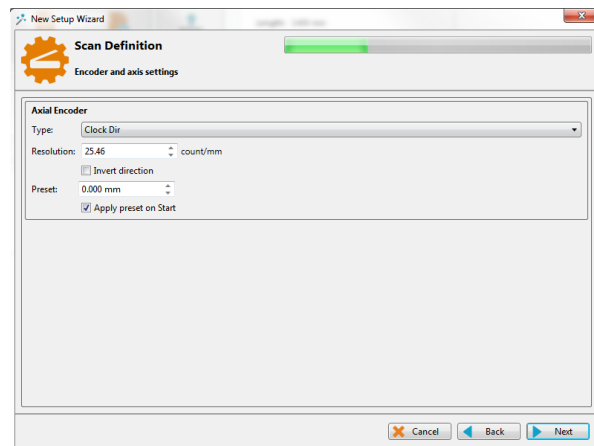
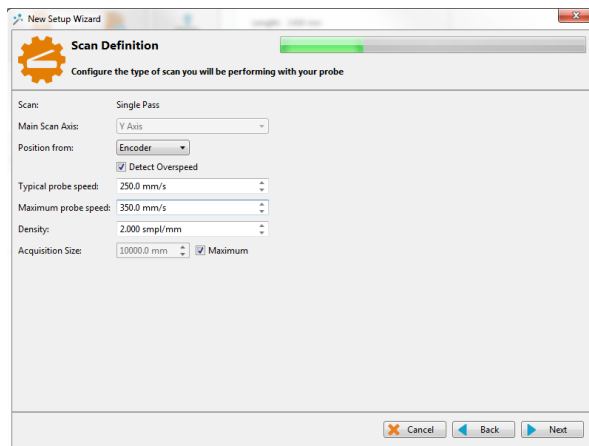

On the first page, the *Typical probe speed*, *Maximum probe speed* and the *Density* will have to be entered. The *Maximum probe speed* is the maximum acceptable speed for your probe and the *Density* is the number of acquired points per millimeter (axial resolution). These values will be used to set the acquisition rate and to optimize the acquisition processes used by the Ectane. Note that if your probe is pulled at a speed exceeding the *Maximum probe speed*, there will be gaps in the data.

The second page includes the type of encoder and its resolution. A preset can also be specified if your acquisition doesn't start at 0 mm.

Click *Next* when you're finished.

## DATA DEFINITION

The *Data Definition* window is used to set the hardware gain, frequency and drive voltage for the *Absolute* and *Differential* channels. It is important to set these parameters correctly before acquiring the data since they are driven by the instrument and cannot be modified during the analysis.

Connector: 19 pins

Channels		
Name	Prefix	Gain (dB)
<input checked="" type="checkbox"/> Absolute	ABS-	56.0
<input checked="" type="checkbox"/> Differential	DIF-	66.0

Required frequencies		
Prefix	Val (Hz)	Ampl (V)
F1	247	5.00

Suggest      + Add

Cancel      Back      Next

By default, Magnifi suggests a frequency theoretically calculated with the tube parameters previously entered.

The frequency and drive voltage can be changed by replacing their values in the *Required frequencies* table. Up to four frequencies can be set at the same time. And the sum of their amplitude cannot exceed 10V.

Make sure that the frequencies are within the probe limits that you can find in Table 3. If the suggested frequency is not within the recommended probe frequency range, it means that either the probe that you are using is not appropriate for your tube or that one of the tube parameters previously entered was not set correctly.

Another thing to consider when selecting the frequency is the frequency of the power outlet at the location where you are performing your inspection. Under a certain frequency, it is recommended to avoid the harmonics of the outlet frequency to prevent noise issues. The figures below indicate which frequency to avoid.

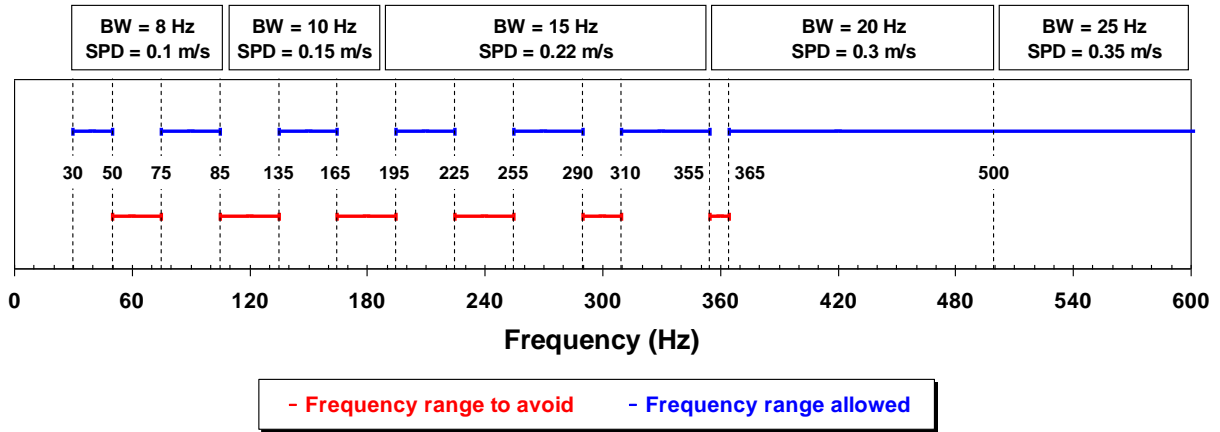

Recommended frequencies for power outlet at 60Hz

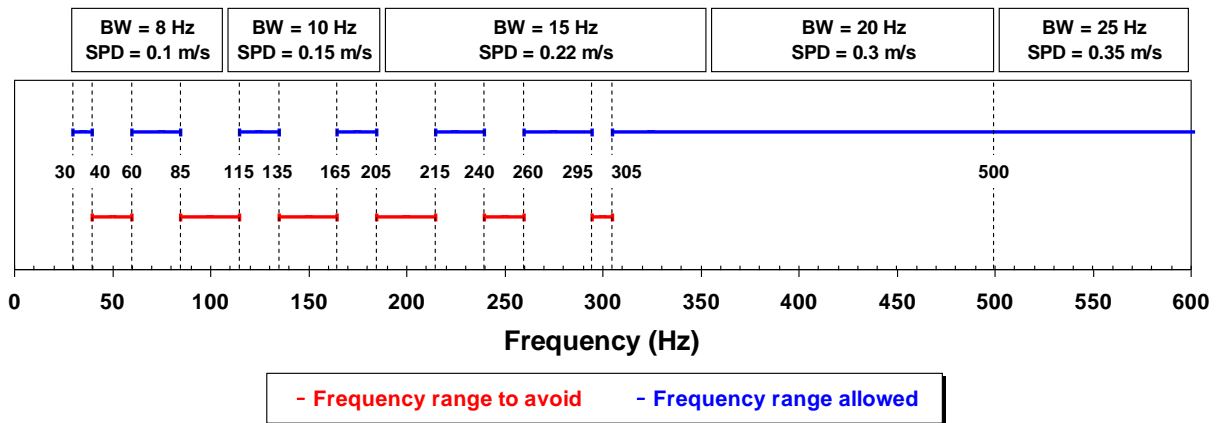

Recommended frequencies for power outlet at 50Hz

Click on *Next* when the desired parameters are entered.

The next window is used to build mixed channels. Mixes are processed channels that are mainly used to detect indication close to support plates. They are built with two frequencies of the same channel type to attenuate the effect of the support plate and to be able to size an indication at this location more accurately.

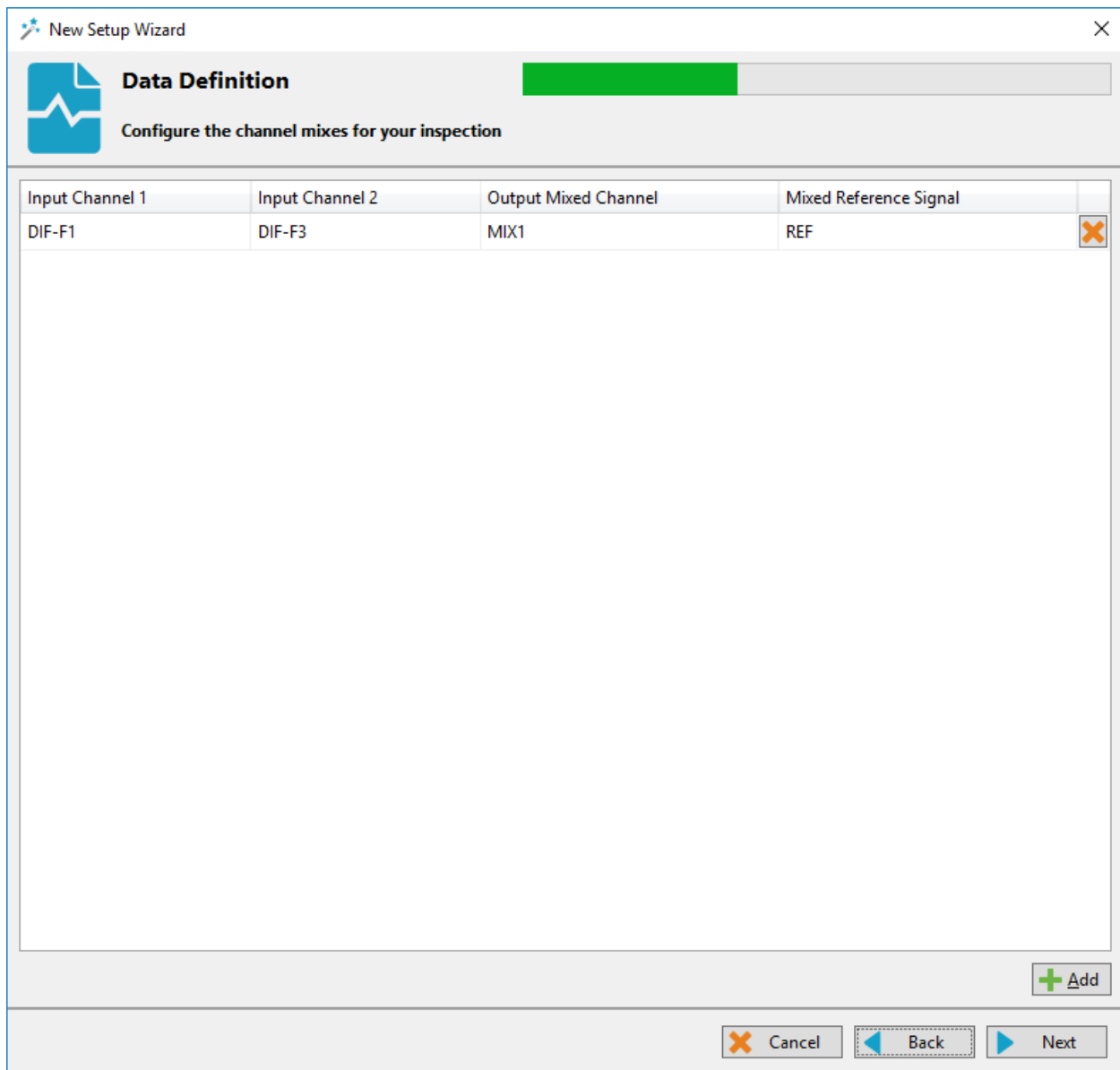

If you do not wish to use mixed channels, click on *Next*.

To add a mixed channel, click on the *Add* button. A new line will appear. Choose from which input you want to use the mixed channel. Note that *Input Channel 2* must have a lower frequency than *Input Channel 1*. Mixed channels can be built for both absolute and differential channels.

You can rename the mixed channel output by modifying the *Output Mixed Channel* field.

The mixed reference signal (usually a support plate signal) will be used to calibrate the mix channel. The system will apply processes to the chosen input channels and will subtract them to attenuate the reference signal.

Click on *Next*.

## DATA PROCESSING

The *Data Processing* window is used to configure the signal processing to apply to the channels.

You can choose to configure every frequency individually or you can apply the same filters to every channel with the *Individually configure all the channels* check box.

Note that the signal processing is done after the data acquisition. An inappropriate parameter choice can be changed without any problem during data analysis, while wrong parameters choice for the data acquisition can mislead the analysis. It is possible to change the filters parameters after data acquisition, so it is always possible to fine tune the filters parameters during analysis.

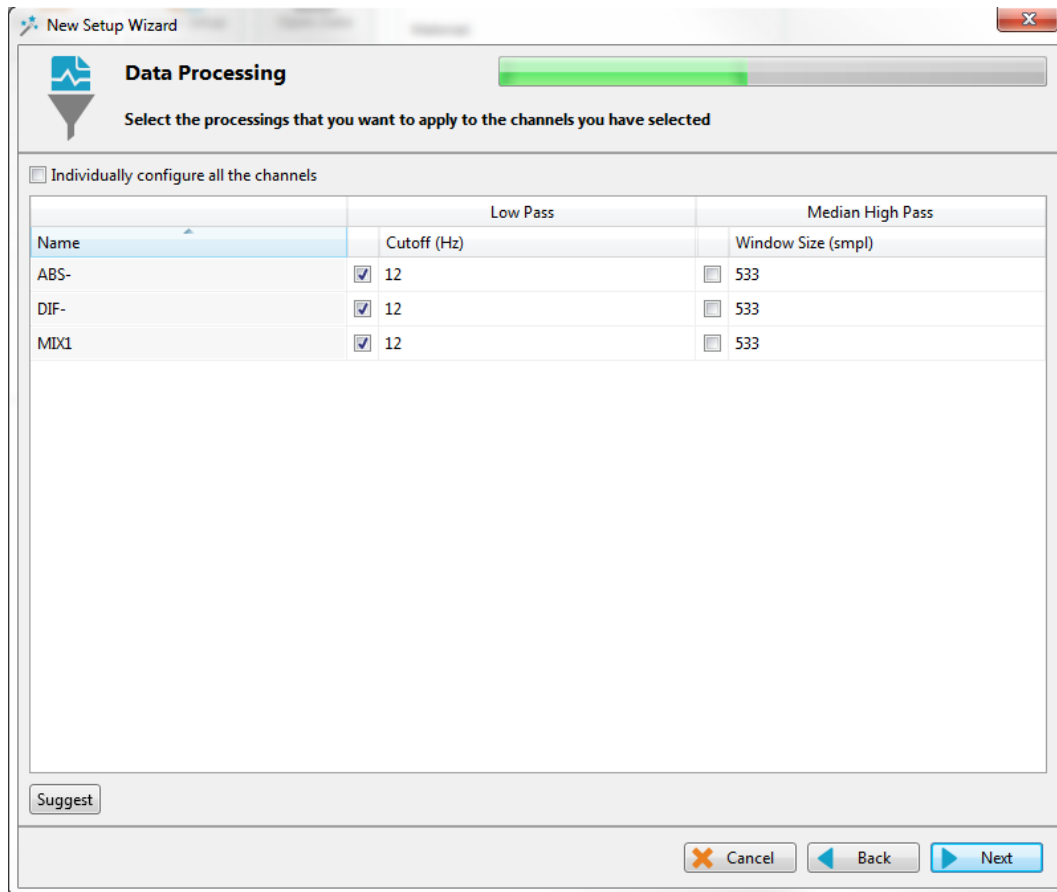

The low pass filter eliminates part of the signal that is above a certain frequency. As an example, it is useful when your defect signal has a lower frequency content than the background noise. In this case, using a filter will remove part of the noise without removing the defects signals. This may help with data analysis. However, a cutoff frequency that is too high won't remove much noise, and a cutoff frequency that is too low will filter out the defect's signals.

The median high pass filter is used to filter out low frequency noise or drift such as lift-off variations of the probe within the tube, changes in material, geometry or thickness. As a rule-of-thumb, the width of high-pass median filter should be set to at least three times the axial length of the longest flaw that may be encountered. Data should be examined in both its filtered and unfiltered states. It is important to keep

in mind that the median high-pass filters can distort phase. More information about median filters for NDT analysis can be found on Eddyfi's blog.

Click *Next* when you are done.

## CALIBRATION POINTS

The *Calibration Points* page is used to define the points in your calibration tube. These indications will later be used to calibrate your probe and to build sizing curves.

The units of measurement can be set in percentage or in depth (millimeters or inches).

You can add calibration points by clicking on the *Add* button. Specify the calibration point name, side and size. The side and size of the flaw will be used to position the calibration point on the sizing curve(s). However, it should be note that RFT doesn't allow an indication side differentiation.

Calibration points can also be imported with the *Import* button.

Name	Side	Size	
HOLE	Through	100.0	✕
FBH-80	None	80.0	✕
FBH-60	None	60.0	✕
FBH-40	None	40.0	✕
4 x FBH-20	None	20.0	✕
GR-40	None	40.0	✕
GR-60	None	60.0	✕
SUPPORT	Unknown	0.0	✕
REF	None	0.0	✕



Click *Next* when you have set the required calibration points for your calibration(s) and sizing curve(s).

## CALIBRATION

The *Calibration* page is used to define the calibration method that will be used to set the amplitude(s) and phase(s) of a channel using the selected measurement method.

By default, the calibration is performed on the Hole signal by adjusting it to 1V and 90° on the differential channel. The calibration can be done differently on each channel type. It can also be done individually for each frequency by selecting the *Individually configure all the channels* option. Different reference signals can be set to calibrate the phase and the amplitude independently.

**Calibration**  
Configure parameters to calibrate channel amplitude and phase

Individually configure all the channels  
 Use Voltage Plane representation for absolute (ABS) channels  
 Link differential (DIF) channels rotation and gain to the absolute (ABS) channels normalization

Name	Amplitude			Phase		
	Voltage (V)	Reference	Measurement	Angle (°)	Reference	Measurement
ABS-	1.00	SUPPORT	PP	0.0	SUPPORT	PP
DIF-	1.00	HOLE	PP	90.0	HOLE	PP
MIX1	1.00	HOLE	PP	90.0	HOLE	PP

Cancel Back Next

You can use a voltage plane for the absolute channel(s) by selecting the Use Voltage Plane representation for absolute (ABS) channels option. This option is selected by default. Voltage planes are polar plot in which theoretical curves show the effect of depth variation on the signal. They are used with RFT to estimate the depth and coverage of a flaw. More information on these views can be found in Appendix 1. The voltage plane option will allow you to use the functions offered by Magnifi to match the signal with

theoretical curves. With this option, calibration settings will be grayed because the calibration can't be done with a single reference point when using a voltage plane.

A second option can be selected if voltage planes are used (*Link differential (DIF) channels rotation and gain to the absolute channel (ABS) normalization*). This option links the absolute and the differential channel. When an inspection is performed, certain tubes can have properties that are different from the calibration tube. This will change the operation point position and the built sizing curves won't be applicable to the inspected tube. Bringing back the operation point to a reference point makes the sizing curves compatible again. Automatic and manual functions can be used to do this operation. With the second option checked, the gain and phase rotation applied on the absolute channel will also be applied to the differential channel. If this second option is not selected, the adjustment of the differential channel will be done separately. The ways to perform these adjustments is explained in the *Inspection* section of this document.

If the voltage plane option is not checked, the absolute channel will be calibrated with the reference signal(s) selected in the calibration page.

When you select the reference signal, the system will use the selected measurement method to apply a rotation and a gain. Here is a short description of the available options:

- 1. Absolute (A):**  
Uses a straight line from the Lissajous origin to the main cursor position to measure amplitude.
- 2. Absolute Horizontal (AH):**  
Uses only the horizontal component, from the Lissajous origin to the main cursor position to measure amplitude.
- 3. Absolute Vertical (AV):**  
Uses only the vertical component, from the Lissajous origin to the main cursor position to measure amplitude.
- 4. Absolute Peak (AP):**  
Uses a straight line, from the Lissajous origin to the peak value of the data selection, to measure amplitude.
- 5. Absolute Peak Horizontal (APH):**  
Uses only the horizontal component, from the Lissajous origin to the peak value of the data selection, to measure amplitude.
- 6. Absolute Peak Vertical (APV):**  
Uses only the vertical component, from the Lissajous origin to the peak value of the data selection, to measure amplitude.
- 7. Average Peak (MP):**  
Takes the distances from points at the extremity of the cursor to the peak of the data selection to build an average vector. Only used and recommended for absolute signals.
- 8. Average Peak Horizontal (MPH):**

Uses the horizontal component of the distances from points at the extremity of the cursor to the peak of the data selection to make an average vector. Used for absolute signals.

**9. Average Peak Vertical (MPV):**

Uses the vertical component of the distances from points at the extremity of the cursor to the peak of the data selection to make an average vector. Used for absolute signals.

**10. Peak to peak (PP):**

Uses the combination of the vertical and horizontal component to measure the maximum amplitude.

**11. Horizontal (PPH):**

Uses only the horizontal component to measure the amplitude.

**12. Vertical (PPV):**

Uses only the vertical component to measure the amplitude.

**13. Peak to peak First Transition (PPF):**

Uses the combination of the vertical and horizontal component of the first transition of the signal to measure maximum amplitude. The first signal transition is from the base of an indication to its peak.

Click on *Next* when the parameters in the table are set according to your requirements.

## **SIZING CURVES**

The first page of this section is the definition of your sizing curves. A curve will be built for each line in this table.

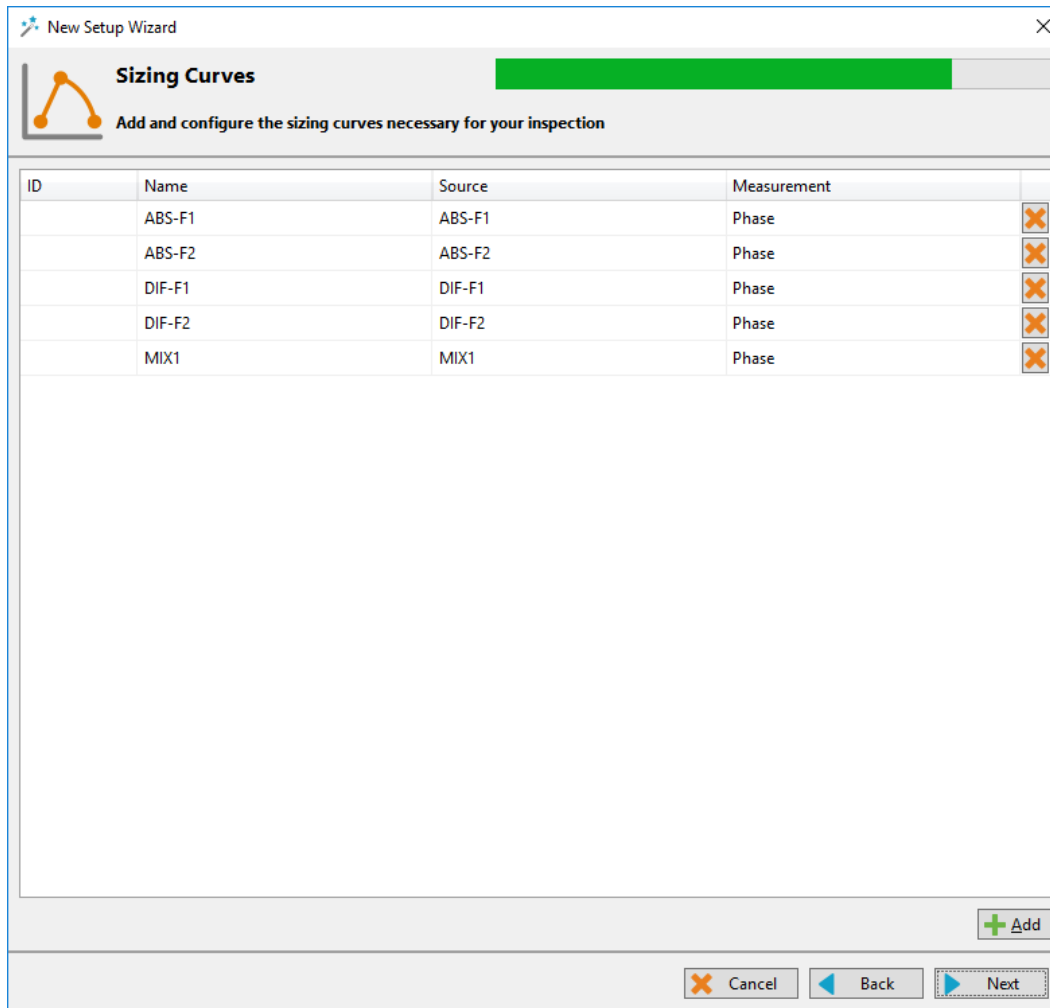

The sizing curve will allow you to estimate the size of a defect based on the calibration points signals (amplitude or phase) obtained with your calibration standard. Magnifi will give you the interpolated flaw size base on the built sizing curves.

Sizing curve names are customizable. The channel source and measurement type can also be changed. You can add sizing curves by clicking on the *Add* button.

Click *Next* when you are done.

For every sizing curve created in the last window, a window will appear to configure the curve properties. The name of the curve will be shown in the upper left corner of the page (ABS in the example below).

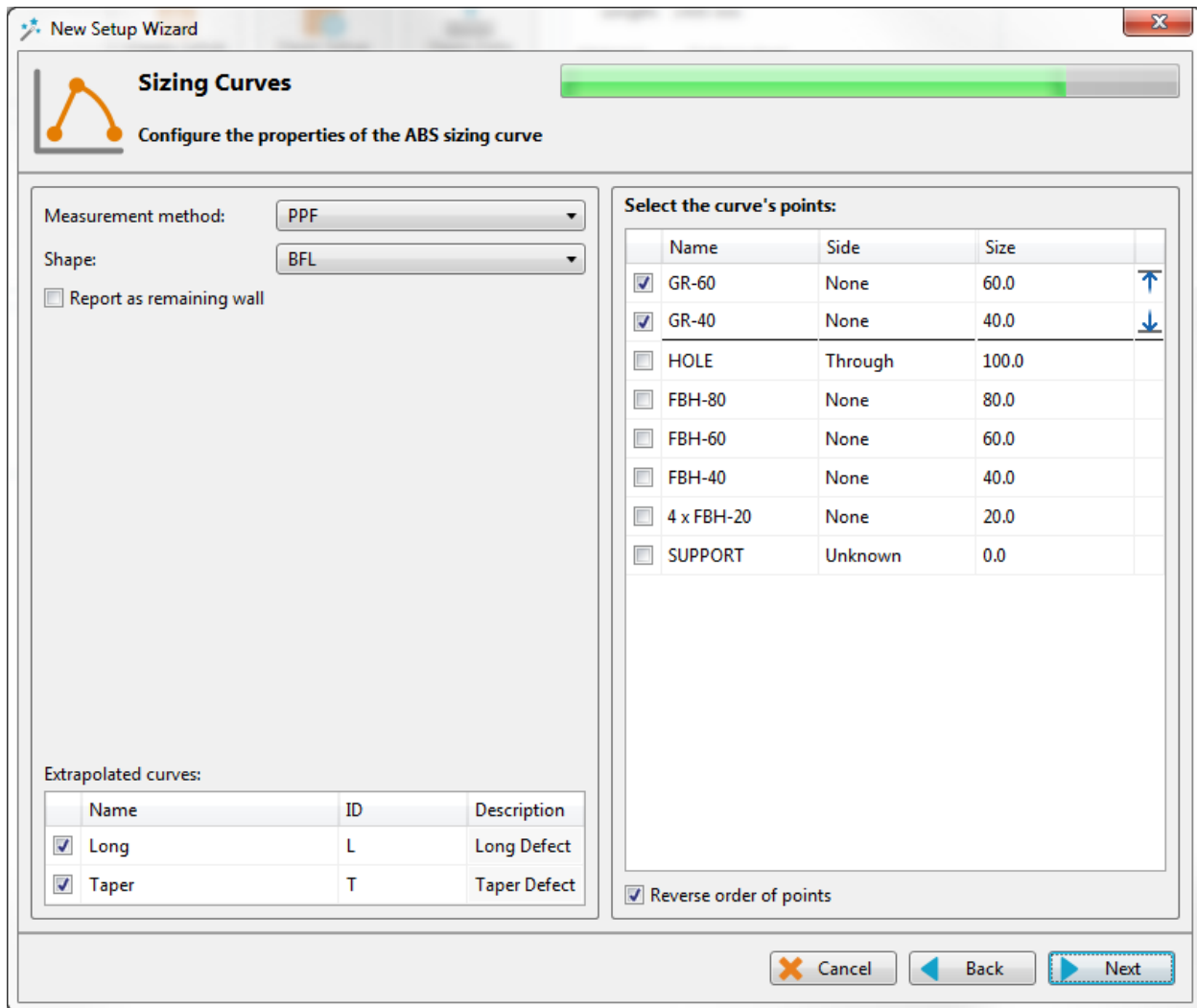

The measurement methods options are the same as what is described in the calibration section of this document. By default, the *Peak to Peak First Transition* (PPF) option is set for absolute channels, and the *Peak to Peak* (PP) option is used for the differential channels.

The interpolation method can be selected with the *Shape* dropdown menu. Here is a short description of the available options:

1. **Best Fit (Dual linear) (for phase measurement only):**  
A curve with two linear segments representing ID and OD (or Near and Far) side calibration points with respect to phase.
2. **Best Fit (Dual Slope) (for phase measurement only):**  
A curve with two segments representing ID and OD (or Near and Far) side. The ID section is linear and the OD section is polynomial. The OD side of the curve will need at least three points (including the hole) in order to trace a polynomial curve.
3. **Best Fit (Polynomial) (for phase and amplitude measurements):**  
Best polynomial (degree 2) interpolation within the measured (requiring at least three points).

**4. Connected Points (for phase and amplitude measurements):**

Simple, point-to-point curve.

**5. Best Fit (Linear) (for phase and amplitude measurements):**

Best linear interpolation within the measured calibration points

**6. Best Fit (Dual Polynomial) (for phase and amplitude measurements):**

Polynomial (degree 2) interpolation with two segments for both ID and OD sides of the curve.

Need at least three points.

The linear options are mostly used when few data points are available, while the Best fit (Dual Polynomial) option is a more precise method when your calibration tube has multiple defects.

Once the measurement method and the interpolation curve shape are chosen, you can select the curve points for each sizing curves previously created. The order in which the points appear in the list will influence your curves. Make sure that the measured values of the calibration points are in the desired order. You can use the *Reverse order points* option to associate the deepest flaw with the smallest measured value.

For the absolute channel(s), two additional extrapolated curves will be created by default for each sizing curve. These curves will give the depth of a flaw that is considered *Long* or *Taper*. A description of these types of flaws can be found in Appendix 1.

Extrapolated curves:

	Name	ID	Description
<input checked="" type="checkbox"/>	Long	L	Long Defect
<input checked="" type="checkbox"/>	Taper	T	Taper Defect

You can set Magnifi to show the remaining wall instead of the defect size by checking the box Report as remaining wall thickness.

Click Next when you are done.

## INDICATION CODES

The *Indication Codes* page is used to define the entries that can be added to the report when analyzing the data.

Code	Description	Type	Automatic	Color	
COR	Corrosion	Defect			X
CRK	Crack	Defect			X
DNT	Dent	Defect			X
DSI	Distorted support indicatic	Defect			X
ERO	Erosion	Defect			X
NDD	No defect detected	No indication			X
OBS	Obstructed	Feature		Red	X
PIT	Pitting	Defect			X
PLG	Plugged	Feature		Brown	X
RST	Restricted	Feature		Yellow	X
WLL	Wall loss long	Defect			X
WLS	Wall loss short	Defect			X
WLT	Wall loss taper	Defect			X

When an indication is added, its abbreviation (code) is shown in the code pane, next to the data.

You can modify the default indications codes list by changing the parameter in the table. New indications can be defined by clicking on the *Add* button.

Click *Next* when you are done

## DISPLAY

The first *Display* window is used to set how the data is displayed during and after the acquisition.

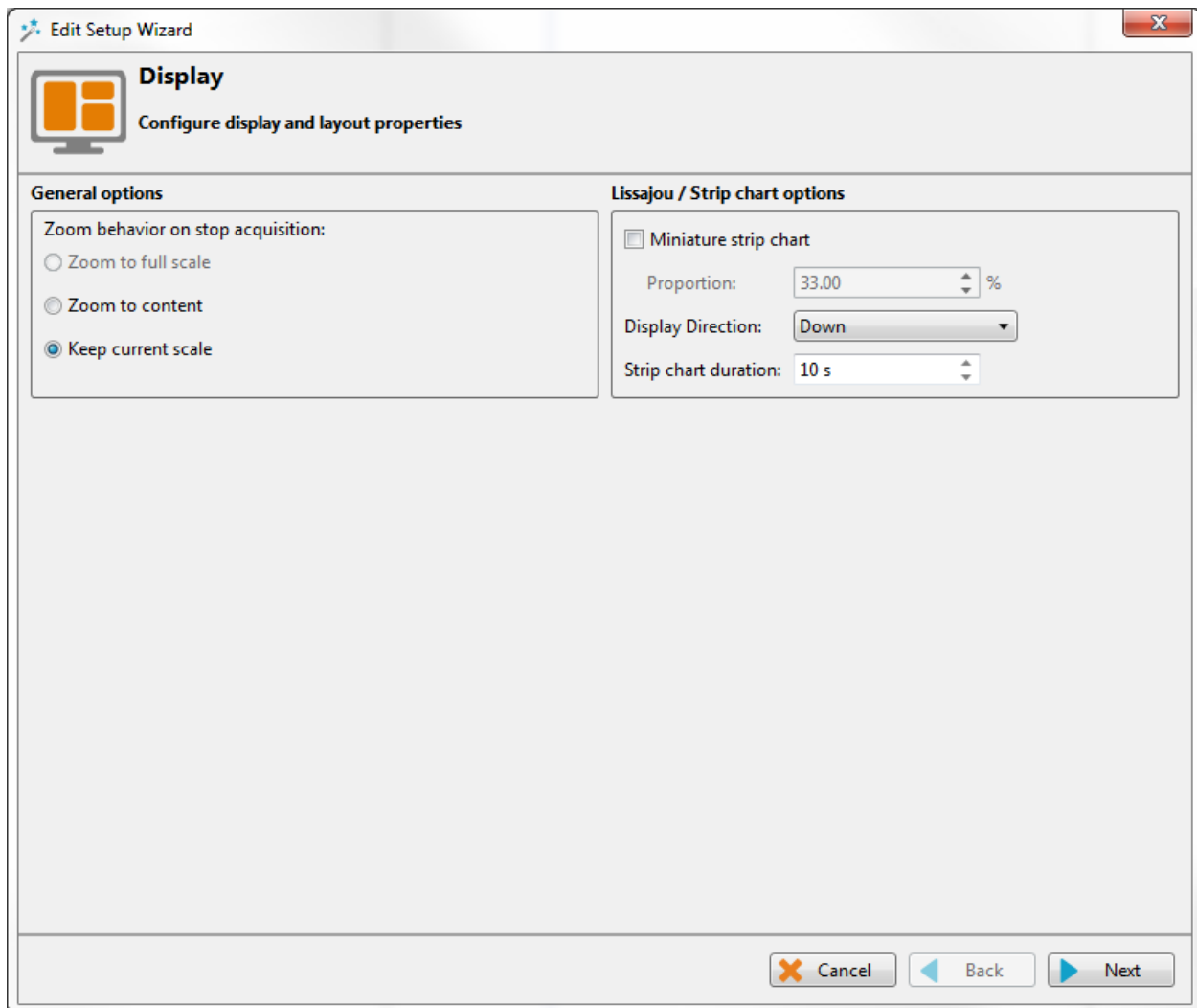

The scroll direction is the direction in which data appears on the screen. If you choose downward, the signals will go from the top to the bottom of the screen. If you choose the upward direction, the signal will go from the bottom to the top of the screen.

You can enable/disable the miniature strip chart under the Lissajous by checking/unchecking the box.

The strip chart duration is the length of a Strip chart window when the data is acquired.

Click *Next*.

The second *Display* window is used to set the layouts. Checking the tick boxes in this window will make the proposed layouts in your setup. You will be able to switch from one to the another via the layout tab. The " C " stands for Code, " S " stands for Strip chart, " L " for Lissajous and " V " for Voltage plane.

The layout with the blue background will be the one opened by default, which can be changed to your desired option.

Layouts can be readjusted at any time.



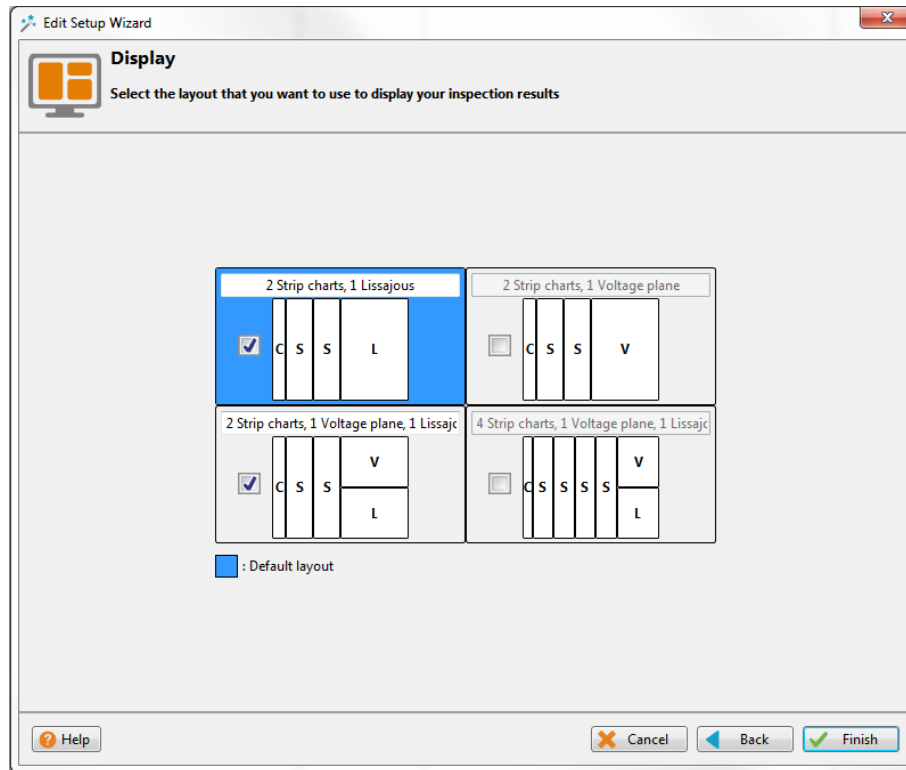

Click *Next* to complete the setup wizard process.

## SETUP MODIFICATIONS

Some parameters or preferences may need to be modified after the *Setup Wizard* process. To modify the parameter previously entered, you can go to the *Setup* tab in the *Frontstage* and click on the button associated with the parameter you want to change.

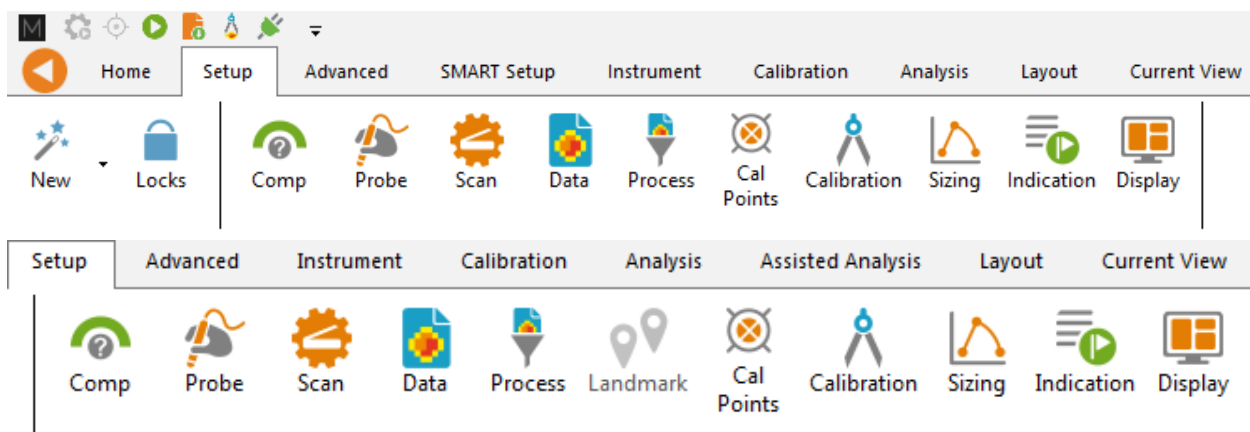

This will open one of the windows previously described, where you can change the the values you originally entered. If applicable, go through the process by clicking on *Next*, and then click on the *Finish* button. This will apply the modification to the setup.

Advanced settings can be found under the *Advanced* tab of the *Frontstage*. If parameters are changed using these advanced settings, the information shown using the *Setup* tab may not match your actual setup.

## SMART SETUP TOOLS

---

Additional functions, which facilitate data analysis, can be set up under the SMART Setup tab.

### LOGBOOK

The first button on the left side under the SMART Setup tab allows you to enable or disable the logbook.

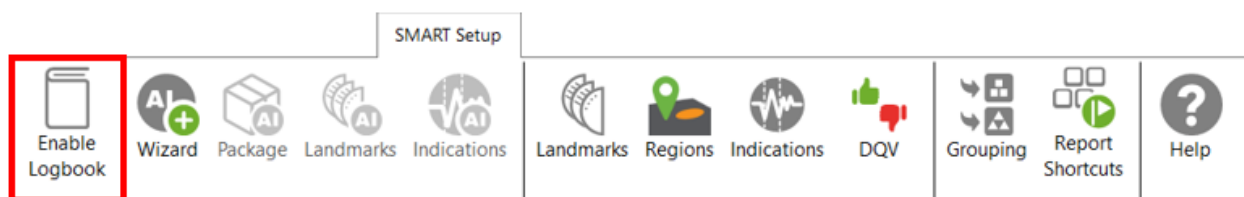





The logbook stores information about the analysis in addition to allowing the following functions: batch screening, seeing results at a glance from the data list pane and saving manual modifications made to the landmarks during the analysis.

The logbook stores the following information: landmarks (type, position, dimension, including manual modifications), indications (AI and conventional, label, position, dimension, etc.), indication grouping, and data quality validation results. When enabled, an additional column is added to the data file list to allow seeing results and to filter, sort, or analyze according to these results.

Zone	Row	Col	Icon
✓ 000	001	001	7x
✓ 002	005	005	3
✓ 002	009	007	2 2
✓ 003	004	009	2
✓ 003	005	012	2
✓ 003	006	007	8
✓ 003	007	006	1
✓ 003	007	010	1
✓ 003	009	007	
✓ 004	003	010	10 2
✓ 004	003	015	1
✓ 004	004	009	18 2
✓ 004	004	014	27 3
✓ 004	005	008	
✓ 004	007	005	
✓ 004	007	015	1x
✓ 004	009	010	2
✓ 004	010	010	Warning

The following table shows the possible icons and their meaning:

Icon	Description	Meaning
(empty)	Empty	No logbook entry associated with this file because it has not been screened yet.
	Dashed outline circle, without a number	Logbook entry associated with the file contains information such as landmark detection or regions. The absence of additional information on the icon reveals that no indication detection engine or DQV tests were enabled when the logbook was written.
	Dashed outline circle, with a number	Logbook entries associated with the file contains information such as landmark detection as well as detected indications. The number displayed inside the circle shows the quantity of potential indications detected. No DQV tests were enabled when the logbook was written.
	Dashed outline circle, with a green check mark	The green check mark indicates that the DQV test(s) passed on this file.

	Dashed outline circle, with a red cross	The red cross indicates that at least one DQV test(s) failed on this file.
	Dashed outline circle, with a number, with a green check mark	The logbook entries associated with this file indicates that potential indications have been detected by the detection engine and that the DQV test(s) passed.
	Dashed outline circle, with a number, with a red cross	The logbook entries associated with this file suggest that potential indications have been detected by the detection engine and that at least one DQV test(s) failed.
	Orange warning triangle	The AI detection tools identified an unusual situation. In this case, the level of confidence in the detection findings could be very low. Therefore, users should pay special attention when reviewing the detection results.

The logbook is saved within the inspection folder. Its data is written when a file is screened using the dedicated buttons in the Analysis ribbon. It is also automatically written when a file is loaded while the logbook is enabled, and no logbook entry existed for this file yet.

It is worth mentioning that the logbook also includes defects and landmarks, even if these have been detected with detection tools that do not use AI (conventional landmark detection and indication boxes). Also note that the automatic indication detection tools are not available if you use the acquisition license (ACQ).

## LANDMARKS

The Landmarks button is used to setup the parameters for landmark detection with conventional tools.

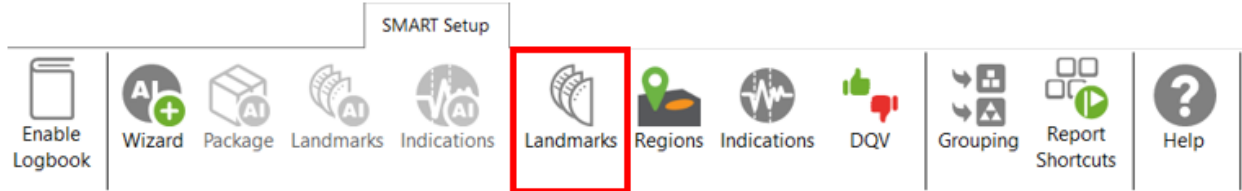

The Landmark Detection window is used to configure the automatic detection of features such as tube sheets and support plates. Landmarks are not mandatory and don't need to be set to have functional setup. They can however give a reference for the axial position in a tube. They can also be used by the software to trigger automatic acquisition sequences.

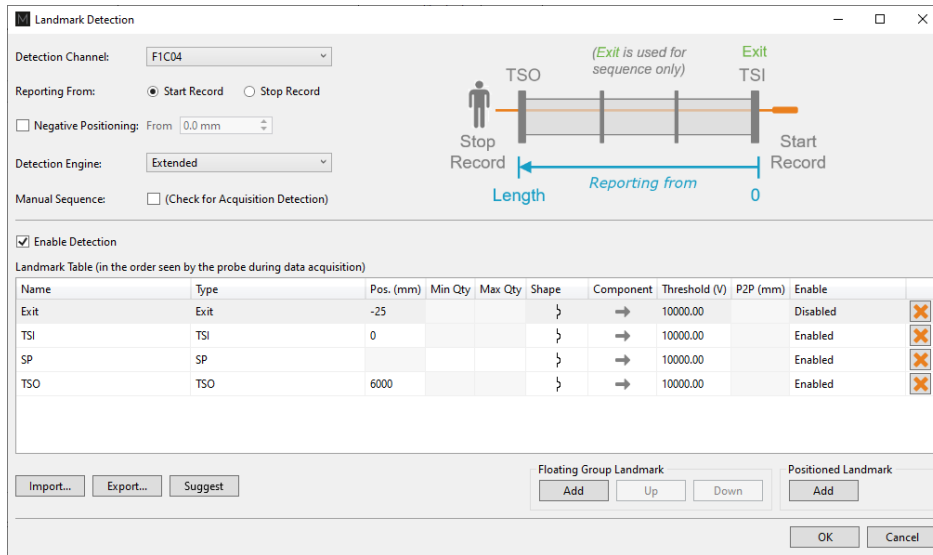

Three landmarks are created if you press on the Suggest button. The channel selected to detect these landmarks should be the lowest frequency absolute channel. The R\_ before the channel stands for Raw. This is the signal of the channel without software filter, rotation, or software gain applied.

You can base the position of your landmarks either on the location where you start to record (usually the tube entrance, opposite from the operator position) or on the place you stop to record (usually the operator side).

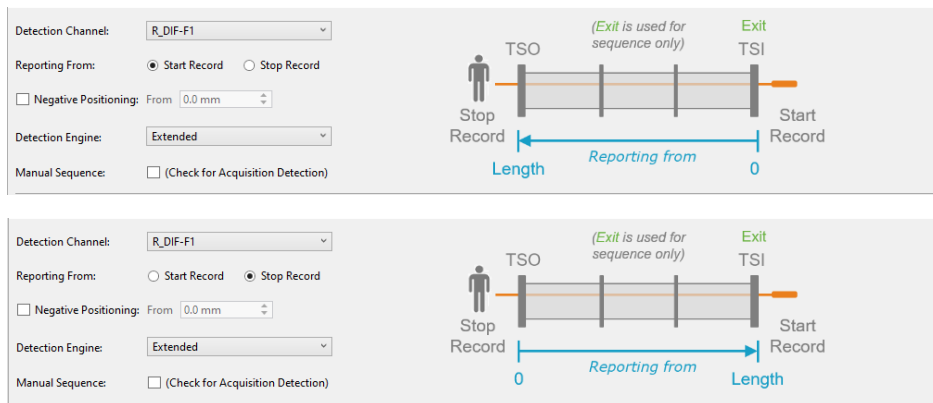

In the above example, the Exit landmark is detected when the probe exits the tube at its outer end. It has a negative position because this event happens before entering the tube. It is enabled only when doing the acquisition.

TSI is the first tube sheet encountered when the probe is pulled. TSO is the last tube sheet encountered at the end of the acquisition.

Landmark detection can be set up manually by describing the shape, component, and voltage threshold that will trigger the detection. The Shape describes the appearance of the signal when the landmark is reached. If a differential signal shape is chosen, the Peak-to-Peak distance ("P2P") will also be needed. The Direction is the projection axis (horizontal or vertical) of the Lissajous signal that will be taken to trigger the landmark. And the Threshold is the voltage amplitude threshold.

Landmarks can be calibrated on real signals; in this case, there is no need to change these parameters as they will be automatically measured by the software. It's important to set the landmark positions as accurately as possible. If the position is not accurately set, the software might prevent their automatic detection since it won't be at an expected position.

The Type field is a name that associates the calibration point with the landmark. If landmarks share the same Type, they will be calibrated at the same time using the same point and process. To associate two landmarks with the same Type, their signal must be the same. If support plates of the same geometry are present in a bundle, they can share the same Type. In the above example, TS1 and TS2 don't share the same Type because one is triggered when the probe goes inside the tube and the other is triggered when the probe exits the tube.

The Detection Engine drop-down menu can be set to Legacy or Extended. With the Legacy mode, all the landmarks need to be entered with the right position. The system will look for the exact number of landmarks entered at positions close to those entered in the table. With the Extended mode, the system will look for a number of landmarks between the Qty max and the Qty min. With this mode, the exact number of support plates don't need to be constant or known.

## REGIONS

The Regions option allows the user to define inclusion/exclusion zones based on Landmarks. This is used to categorize the data to process correctly. For example, they can be useful for restricting the detection of channel saturation to an area within the tube or specify an automatic analysis type for a given region (e.g., under the tubesheets).

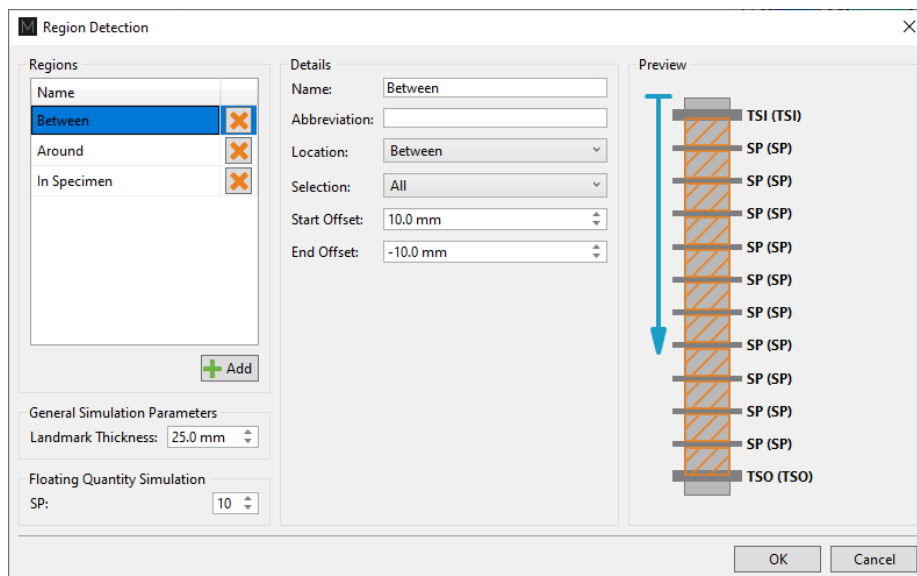
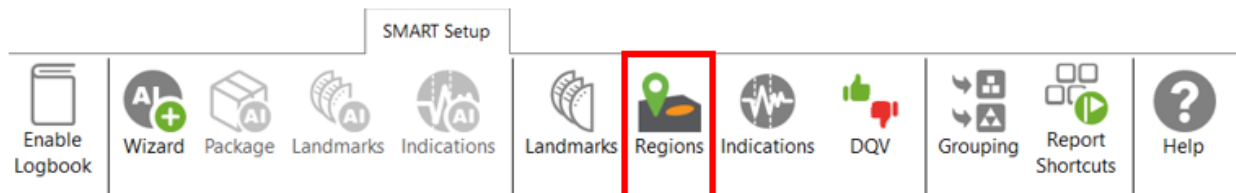

If you are using the conventional detection tools, you can set up the regions according to the automatic analysis tools you will use with the Indications and DVQ buttons (described later).

## INDICATIONS

The Indications module allows the user to define various zones or even waveform types to trigger a certain detection threshold.



These detection zones can be applied to conventional channels and C-scan channels. The Label is the name that will appear in the Code view.

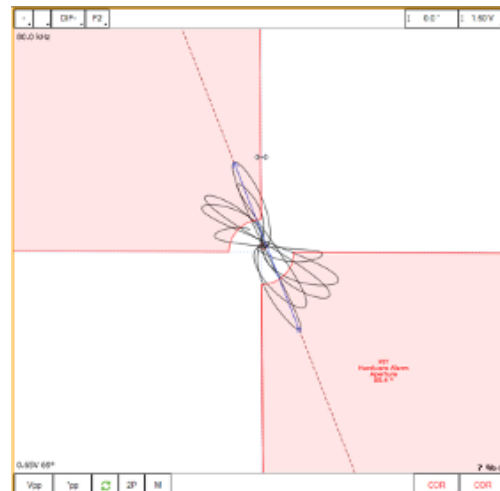
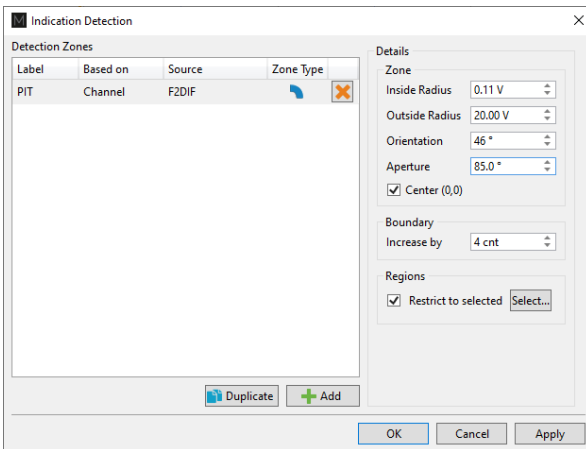





There are five zone types:

	Absolute pie
	Differential pie
	Centered rectangle
	Rectangle
	Over or under a horizontal or vertical threshold

And seven waveform types:

	Up
	Down
	Down-up

	Any direction
	Up-down
	Down-up-up
	Up-down-up-down

Each zone or waveform can be linked to a defined region, and thresholds can be set. The zone types also include the boundary setting to prevent signal oscillation from triggering unnecessary detections.

Detection zone parameters can also be set by clicking on the Lissajous of the used channel and activating the Edit Alarm option on the Current View tab.

The detected indication can be found in the Indication window, which can be activated in the Layout tab.

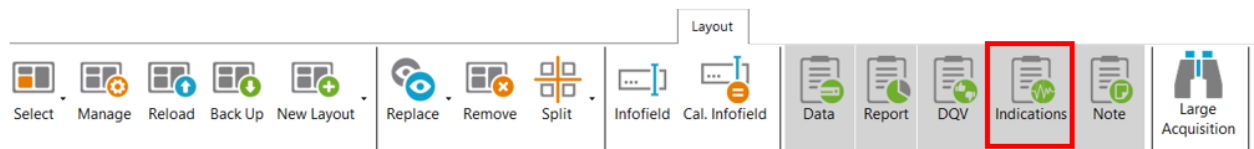

Clicking on an indication in the pane instantly positions the cursor on the selected indication in the Strip chart view. If you click on an indication in the code view (described later), the associated indication is highlighted in the Indications pane.

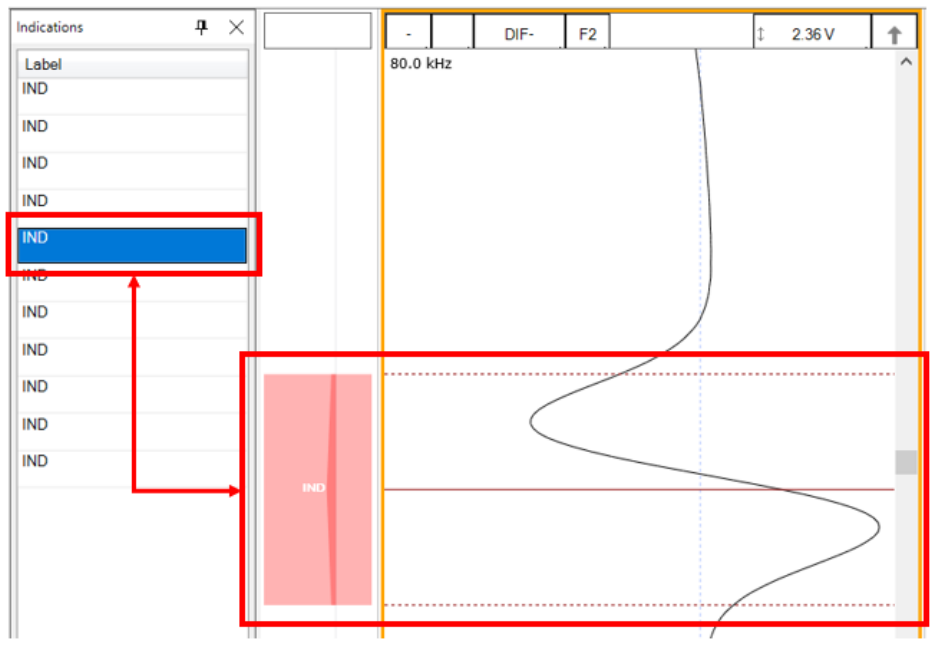

## DATA QUALITY VALIDATION (DQV)

Data Quality Validation allows defining tests to validate the quality of the data.



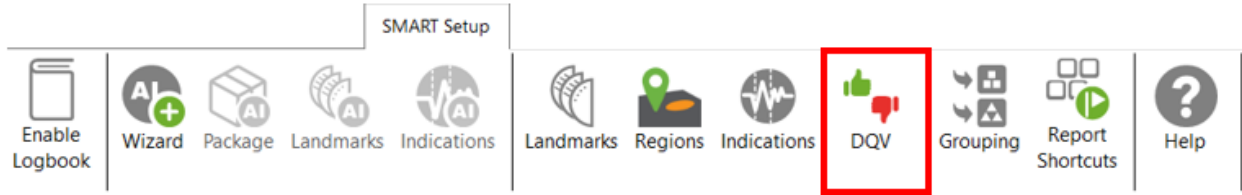

Five test types are available. To add a test, click on the Add button on the DQV page and select the test type with the drop-down menu. Parameters associated with this test can be changed in the Details section of the DQV window.

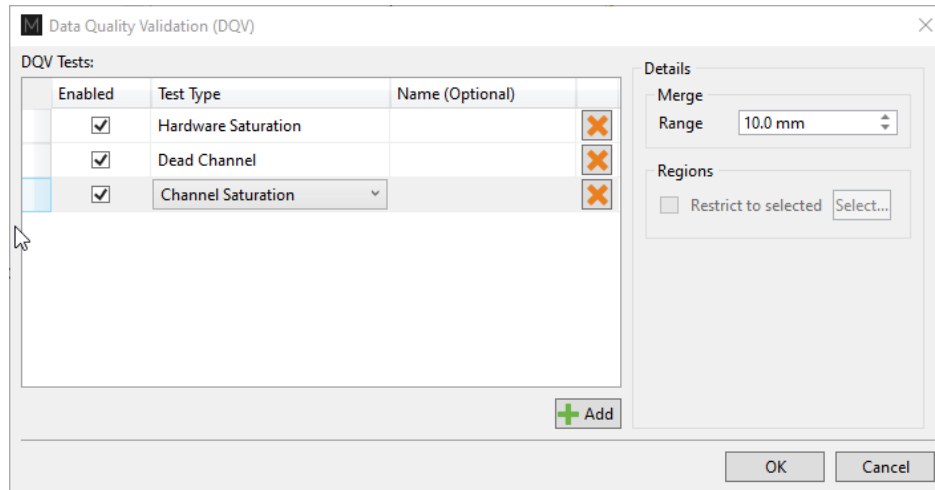

- **Dead Channel:** Verify that channels are reading a signal whose amplitude is above a defined threshold. An amplitude that remains below the threshold throughout the scan indicates a dead channel.
- **Landmark Detected:** Verify the presence of all the selected landmark names in the Details section. To validate full tube-length of straight bundles for ECT bobbin data using AI detection, select this option and check the TSI and TSO landmarks. When AI setup for landmarks is completed and the TWH calibrated, the DQV test will automatically use the AI results to perform the test.
- **Hardware Saturation:** Verify if signal saturation appears on raw channels. The merge field allows grouping a zone together for which the test has failed. This function avoids having many notifications if the test fails several times in one area. This test can be limited to a specific region, for example, the areas inside the tube.
- **Channel Saturation:** Verify if signal saturation appears on calibrated channels. The merge field allows group a zone together for which the test has failed. This function avoids having many notifications if the test fails several times in one area. This test can be limited to a specific region.
- **C-scan Saturation:** Verify if signal saturation appears on C-scans. The merge field allows grouping a zone together for which the test has failed. This function avoids having many notifications if the test fails several times in one area. This test can be limited to a specific region.

The results of the DQV tests can be found in the DQV window, which can be activated in the Layout tab.

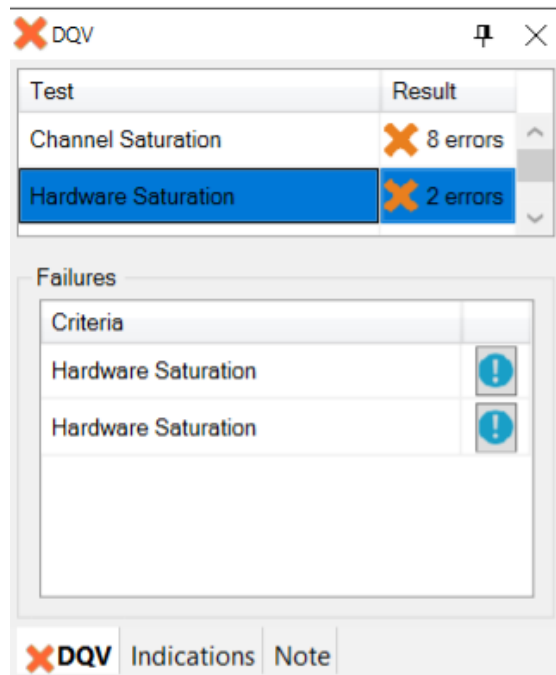
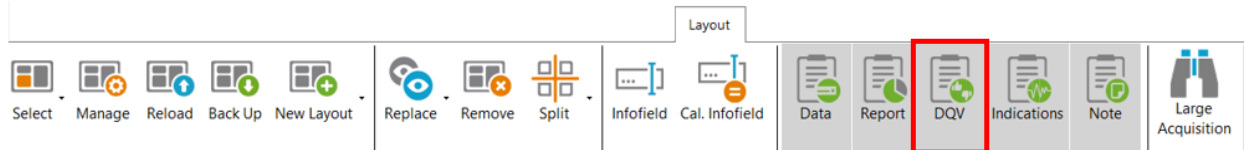

## GROUPING

The grouping tool can help the analyst find critical indications for review as it categorizes and groups the automatically detected indications.

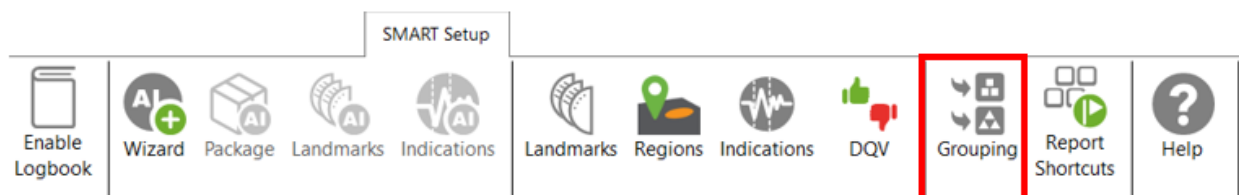

The Grouping menu offers a default configuration with three predefined categories:

- Support Plates
- Critical
- Less Critical

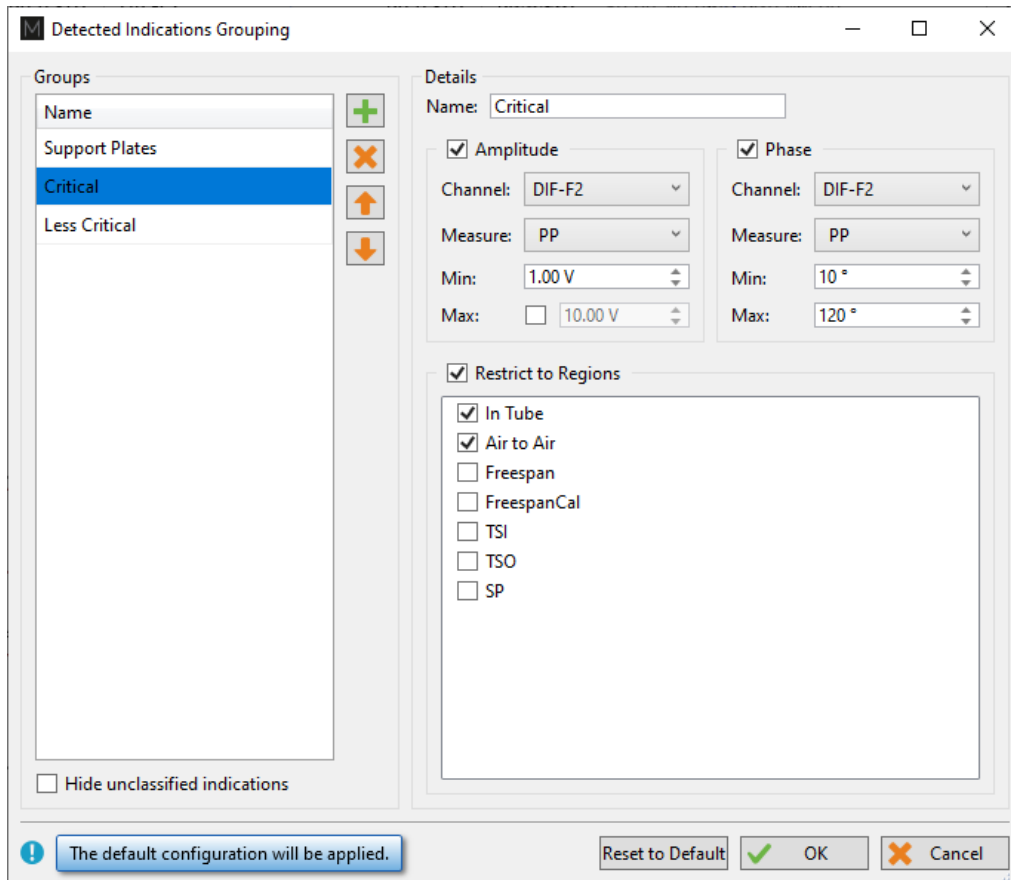

The Details section of each group shows the parameters defining the conditions that must be met for a detected indication to be classified in this group. The user can modify all parameters.

By default, the Support Plates group is configured with the mix channel with a Peak-to-Peak (PP) measurement method, and Max/Min threshold values are set for amplitude and phase. For this group, the criteria are limited to indications detected under the SP regions. As a result, the indications detected under support plates for which all conditions are true will fall into this category.

Critical and Less Critical are two other groups predefined in the Grouping window. Both groups are set on DIF-F2 channel, but with different Amplitude/Phase measurement settings. In both cases, the grouping criteria is restricted to In Tube and Air to Air (for calibration tubes) regions, which covers the full-tube length data.

It should be noted that each automatically detected indication can only be categorized in a single group. Also, the grouping operation is executed according to the order of the groups defined in the Groups list. Therefore, if a given indication meets all the criteria of the first group, it will be categorized in this group. If not, it will be passed to the following group. If it meets all the criteria of the second group, it will be categorized into this one. If not, it will again be passed to the next group, and so on. If an indication does not meet the criteria of any group, it will be placed in the Unclassified group. This implies that every single indication will be categorized, and none can appear simultaneously in more than one group.

New groups can be created with custom parameters.

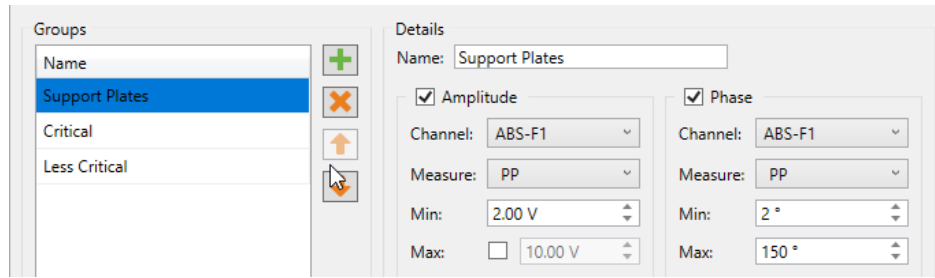

It is also possible to remove a group or use the up/down arrow keys to change the group priority within the list.

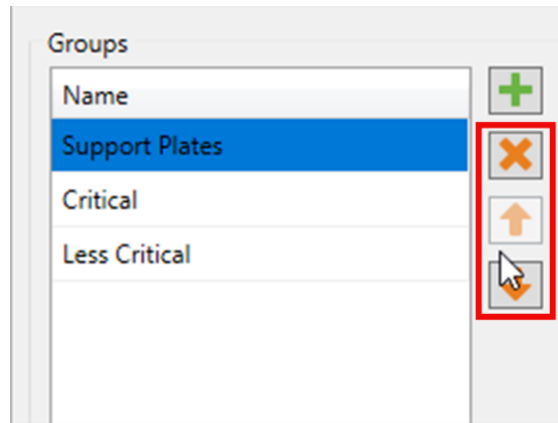

In the Front stage interface, the Grouping results will be displayed in the Indications pane.

Indications 10 of 10 results

Label	Ampl.	Phase
<b>^ Critical (4)</b>		
IND	14.15 V	82 °
IND	3.40 V	83 °
IND	2.78 V	106 °
IND	7.06 V	16 °
<b>^ Less Critical (4)</b>		
IND	1.02 V	111 °
IND	1.00 V	40 °
IND	1.27 V	56 °
IND	1.13 V	73 °
<b>^ Unclassified (2)</b>		
IND		
IND		

DQV Indications Note

To help the analyst focus on the most relevant detected indications furthermore, it is possible to hide the Unclassified indications. To accomplish this, check the box “Hide unclassified indications” at the bottom of the Grouping menu and click on OK.

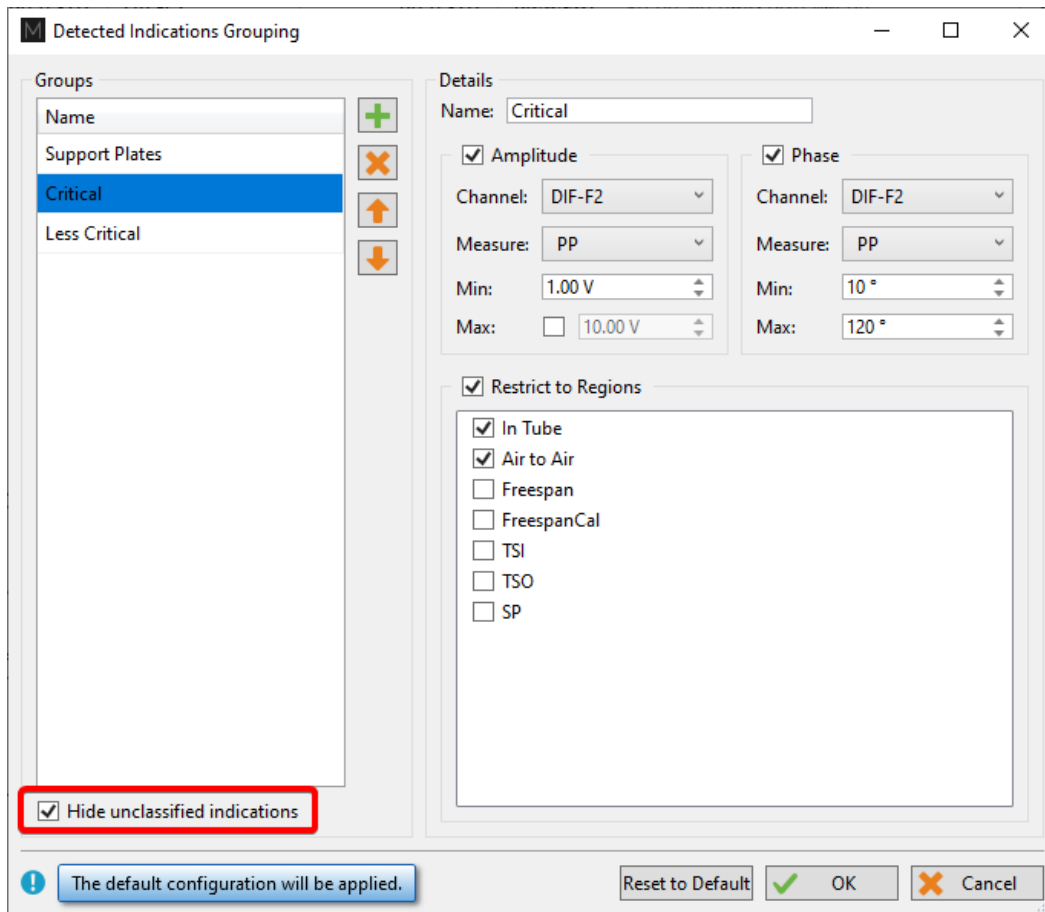

Enabling this option influences the following elements of the software:

- Indications pane;
- Code view;
- Logbook column.

The images below compare them when the Unclassified indications are shown (left) and when they are hidden (right).

When the option is enabled, the Indications pane will not show the “Unclassified” group. The count in the header serves as a reminder to the user that not all indications are currently shown.

Indications 26 of 26 results

Label	Ampl.	Phase
<b>^ Critical (1)</b>		
IND	1.53 V	17 °
<b>^ Less Critical (5)</b>		
IND	1.00 V	14 °
IND	0.93 V	10 °
IND	0.84 V	18 °
IND	0.76 V	17 °
IND	1.20 V	19 °
<b>^ Unclassified (20)</b>		
IND		
IND		
IND		
IND		
IND		

DQV **Indications** Note

Indications 6 of 26 results

Label	Ampl.	Phase
<b>^ Critical (1)</b>		
IND	1.53 V	17 °
<b>^ Less Critical (5)</b>		
IND	1.00 V	14 °
IND	0.93 V	10 °
IND	0.84 V	18 °
IND	0.76 V	17 °
IND	1.20 V	19 °

DQV **Indications** Note

In the Code view, the red markers from the Unclassified indications have been removed.

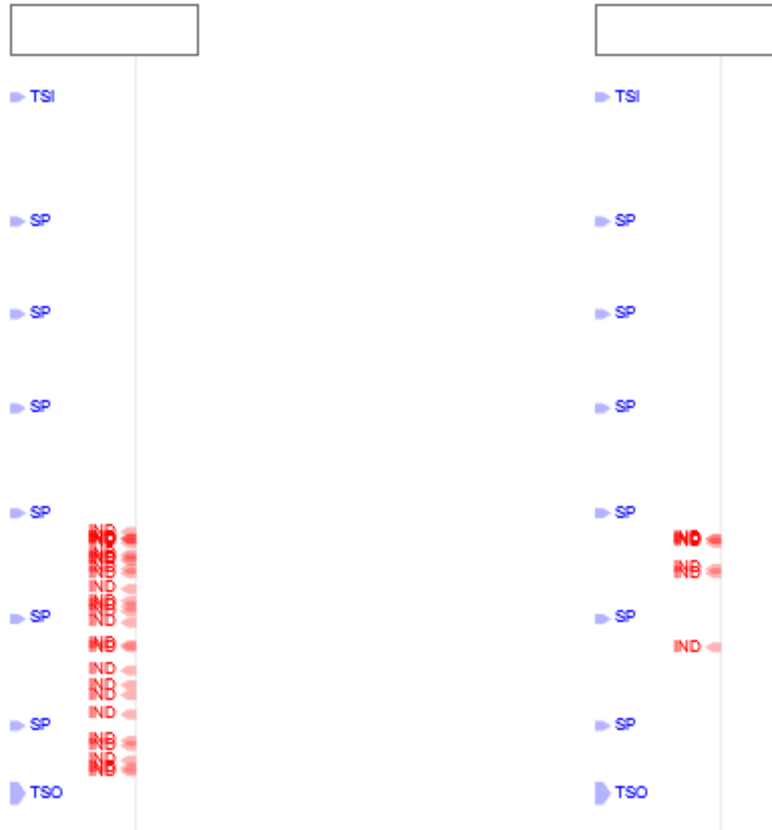

In the data file list, the number shown in the Logbook column represents the number of visible indications, matching the number shown in the header of the Indications pane.

Data	
Row	Col
✓	201000001
✓	201004005
✓	<b>201006009</b> (26)
✓	201006016
✓	201024022
✓	201025017
✓	201025019

Data	
Row	Col
✓	201000001
✓	201004005
✓	<b>201006009</b> (6)
✓	201006016
✓	201024022
✓	201025017
✓	201025019

## REPORT SHORTCUT

Keyboard shortcuts can be used to make entries in the report. By opening the shortcut window, it is possible to select a channel with a measurement method and to associate an indication with it.

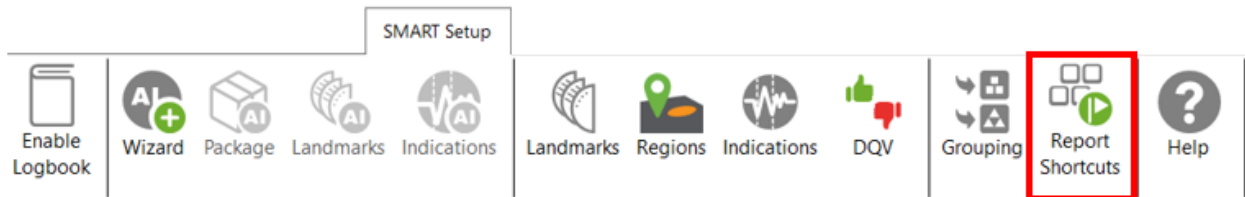

For example, we could use the differential channel F2 with a Peak-to-Peak measurement method to enter pits in the report.

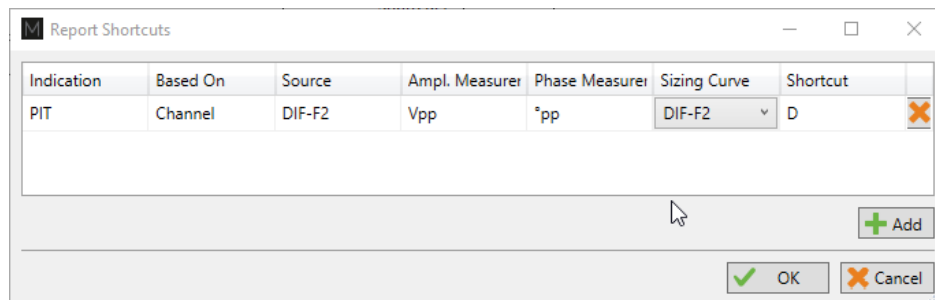

To select a key, press the Shortcut field and press the desired key on your keyboard. It is possible to use a single key or a combination of keys such as ALT+D, for example.

When a report entry is made with the keyboard shortcut, the abbreviation of the type of indication displays momentarily on the corresponding Lissajous.

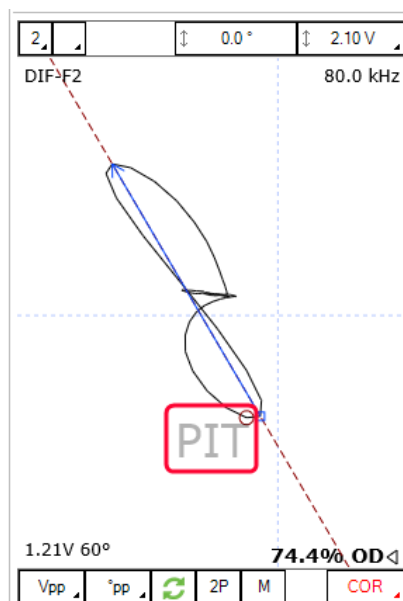



## DATA SCREENING

Data screening set up with the SMART Setup tools can be performed by the two buttons on the left under the Analysis tab.



It is possible to run analysis on a selection of files or all files. The analysis is typically performed on all files when the setup and calibration are adequate. The results are recorded in the logbook and can be viewed in the Data window.

## DATA LIST

---

Magnifi will save a file for each inspected tube. The file names are defined by creating a list of tubes.

This list can be created in the *Data List* section of the *General* tab of the *Backstage*.

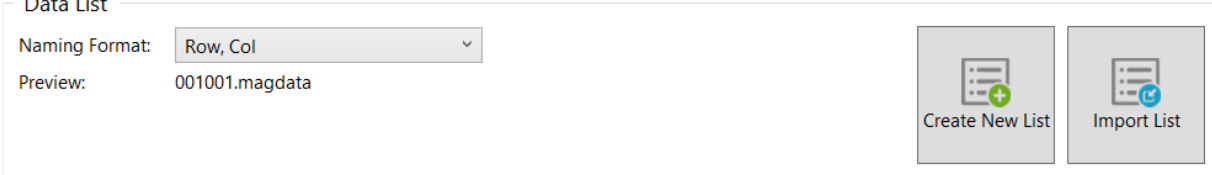

The screenshot shows the 'Data List' section of the software's interface. On the left, there is a 'Naming Format' dropdown menu currently set to 'Row, Col', and a 'Preview' field displaying '001001.magdata'. On the right side of the section, there are two buttons: 'Create New List' (with a plus icon) and 'Import List' (with a plus icon).

Four options are available to set the filename format:

- 1. Free format:**  
Each file has a custom name. Can also be defined from the Data tab of the Front Stage.
- 2. Prefix:**  
The file name includes a defined prefix followed by a sequential number.
- 3. Row, Col:**  
Row number, Column number. Mostly used for tubing inspections.
- 4. Zone, Row, Col:**  
Zone number, Row number, Column number. Mostly used for tubing inspections.

Click on the *Create New List* button. The displayed window will be different depending on the chosen filename format.

For the *Row, Col* option, enter the number of rows, the starting row number and row interval. You can then enter the number of tubes per row in the *Nb. of Columns* fields of the table. Click on *Create* to generate the list of tubes. You can also use the *Create & New* button to add another set of tubes to your list.

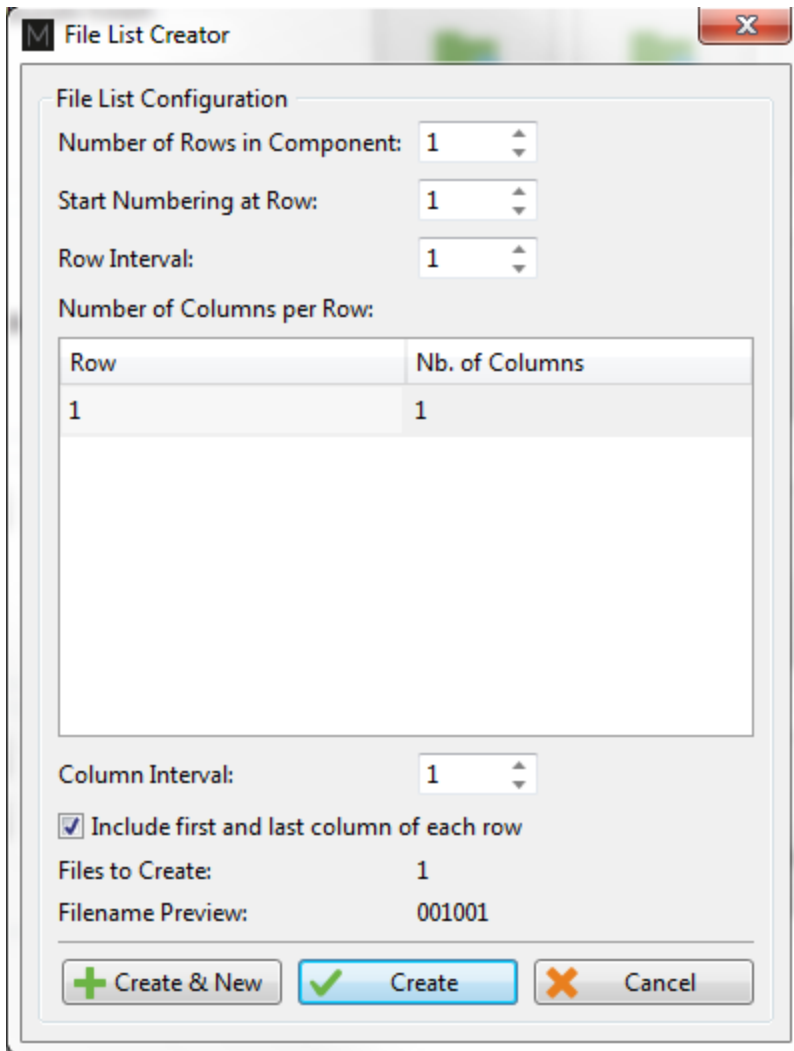

The same principles apply to the other file formats, except for the *Free format* option for which the file name(s) needs to be entered manually in the *Data* window of the *Frontstage*.

The tube list can also be imported from another project using the *Import List* button. The tube list file can be found in the *Inspection* folder. It is also possible to import a list created in the *Tube* software (available from Eddyfi).

## PERFORMING AN ACQUISITION

1. If you are in the *Backstage*, move to the *Frontstage* by clicking on *Start/Resume* button.
2. Click on the *Connect* button under the *Instrument* tab. This will open the *Instrument configuration* page. Click on the line showing the instrument to which you want to connect and then click on *Connect*.



Note: Your Ectane firmware version may not match the version of Magnifi you are using. If this is the case, a red and white X icon will be shown in the *Status* field of the *Instrument connection* window. To download a matching version to your Ectane, click on the *Config.* button and then click the *Send firmware to the instrument* button of the *Instrument configuration* window.

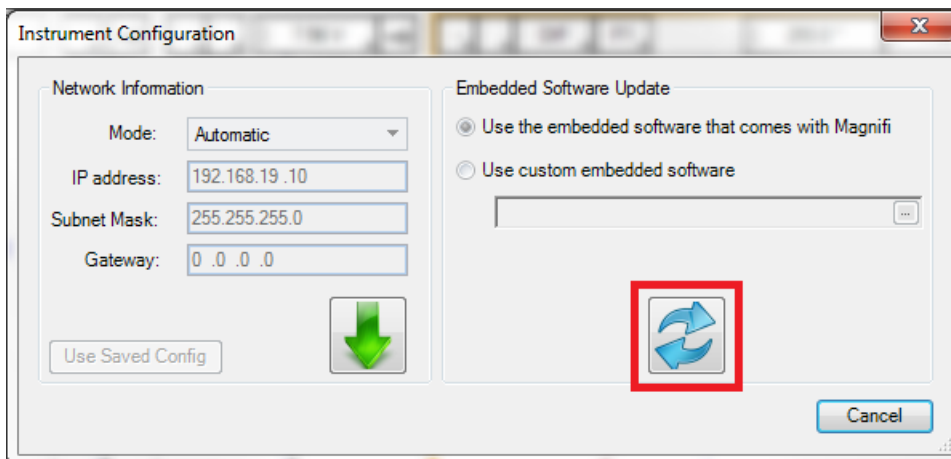
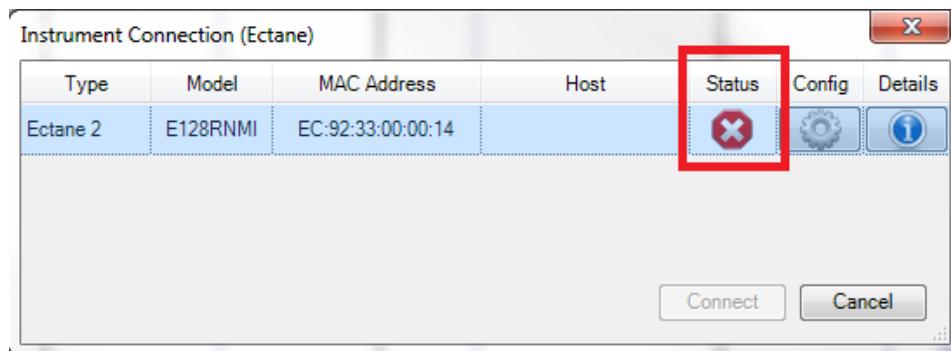

Two acquisition modes are available in Magnifi: *Setup Mode* and *Acquisition Mode*. *Setup Mode* is used to scan your calibration tube and make the necessary adjustments on your setup without saving the data automatically. *Acquisition mode* is used for the inspection. In this mode, the software automatically saves the acquired data using file names based on the tube list.

- For the calibration phase, go to *Setup Mode* by clicking on the *Setup Mode* button under the *Home* tab. This mode is active when the *Setup Mode* button is grayed.

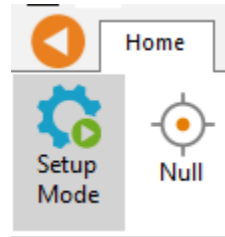

- Plug the RFT probe on the Ectane 19-pin connector.
- If you wish to balance, bring the probe head in a clear area in your standard and balance the probe by clicking on the *Null* button under the *Home* tab, or press F6 on your keyboard.
- Push the probe head all the way through the tube so that it exits the tube.
- Start the acquisition by clicking on the *Acquire* button under the *Home* tab or by pressing the F2 on your keyboard.
- Pull the calibration tube at the appropriate speed
- When it's done, press the *Stop* button or F2 again on your keyboard

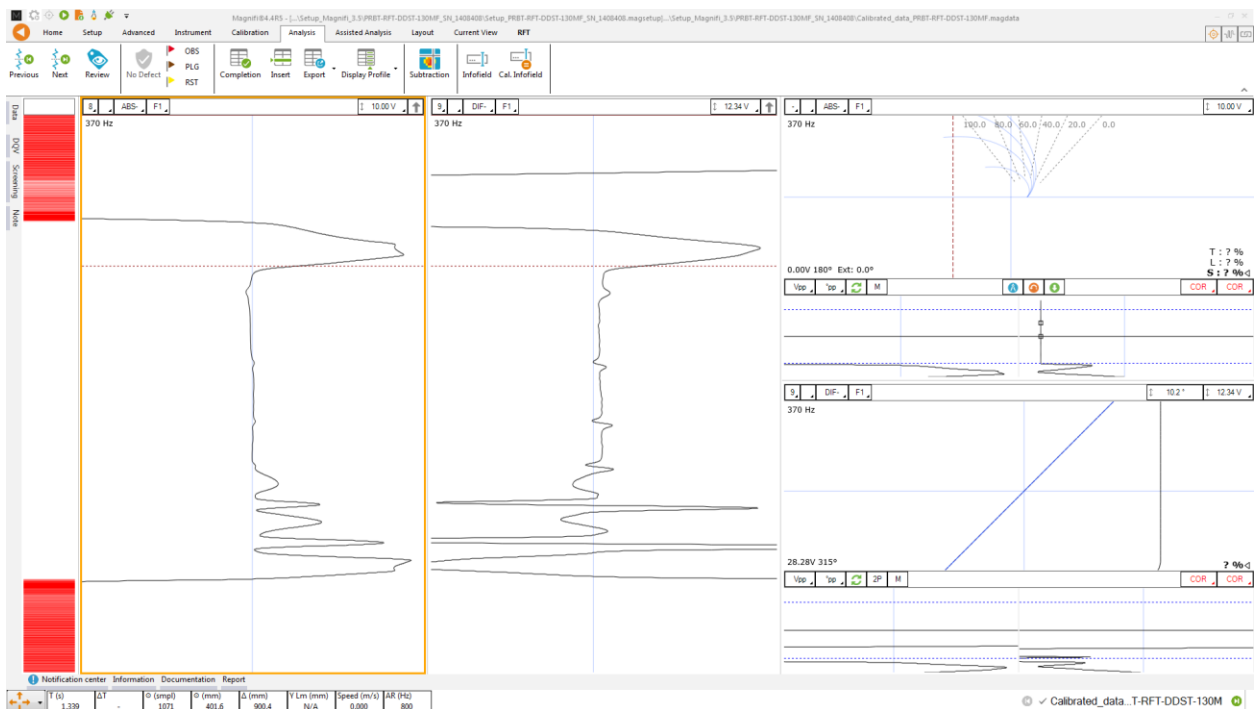

Note that a red zone in the code pane means that at least one of the raw signals is saturated. This is usually the case when your probe is out of the tube.

## VISUALIZING THE DATA

Multiple options are available to select your data and to measure it. The following describes useful functions to do so:

## DISPLAYED CHANNEL

There are four buttons at the upper right corner of the Strip charts and Lissajous windows. These buttons are used for the channel selection.

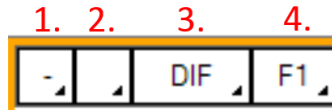

1. Links Strip charts and Lissajous to the same channel. For instance, if a Lissajous and a Strip chart are both set to 1, setting the Lissajous to DIF-F1 will also set the associated Strip chart to this channel.

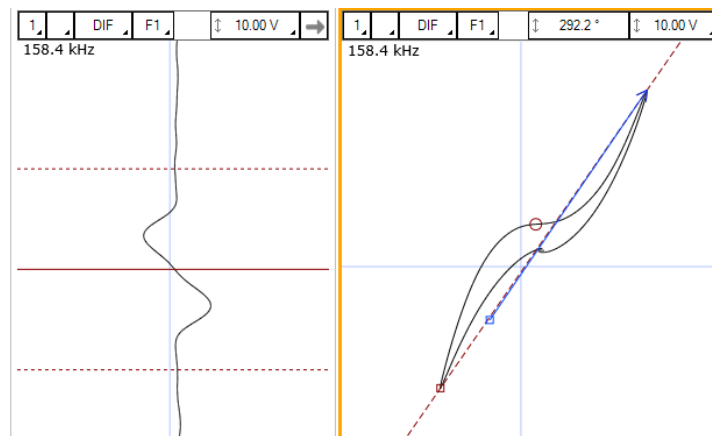

2. Clicking on the corner with the black triangle gives the list of available channels. Click on the desired channel to select it. Right-click or Left-click on this button to switch to the following or previous channel in the list.

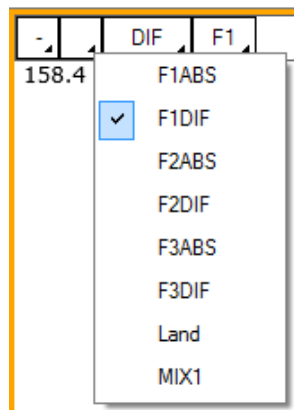

3. Same principle as 2., but for the type of channel only (absolute or differential)
4. Same principle as 2., but for the frequencies only

## STRIP CHART AXIS ORIENTATION

The Strip charts are a projection of the Lissajous on the vertical or horizontal axis. To switch from one axis to another, click on the box showing an arrow at the upper right corner of the Strip chart.

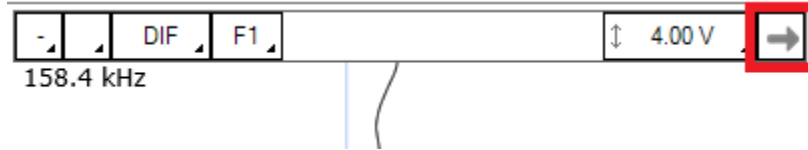

## ZOOMING

On the strip chart, hold the right button of your mouse and drag on the zone of interest to zoom in this section.

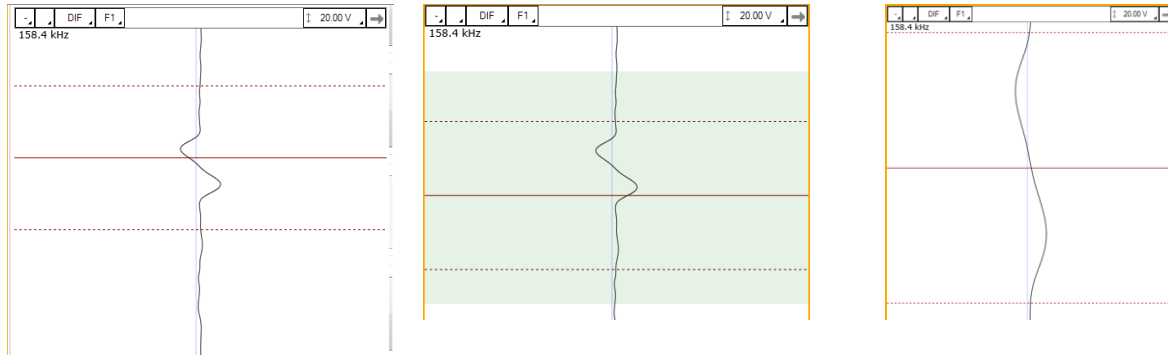

To zoom out, right-click on the Strip chart and select *Previous Zoom* or *Full Extent*.

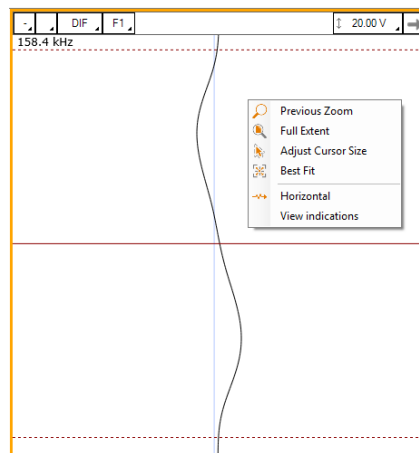

## ADJUSTING THE CURSOR LENGTH

On a Strip chart, the cursor is divided by 3 lines. The dotted lines represent the limit of your cursor and the full line is the center of what you have selected.

Only the portion of data between the dotted lines will be shown in the Lissajous.

To adjust your cursor length, hover your mouse over the dotted line, and click and the left mouse button. This will adjust the 2 dotted line symmetrically. To adjust only one dotted line, do the same operation, but with the right button of your mouse.

## ADJUSTING THE SCALE

The scale of a window (Lissajous or Strip chart) can be modified by clicking on the scale button with the left button (decrease scale) or the right button (increase scale) of your mouse.

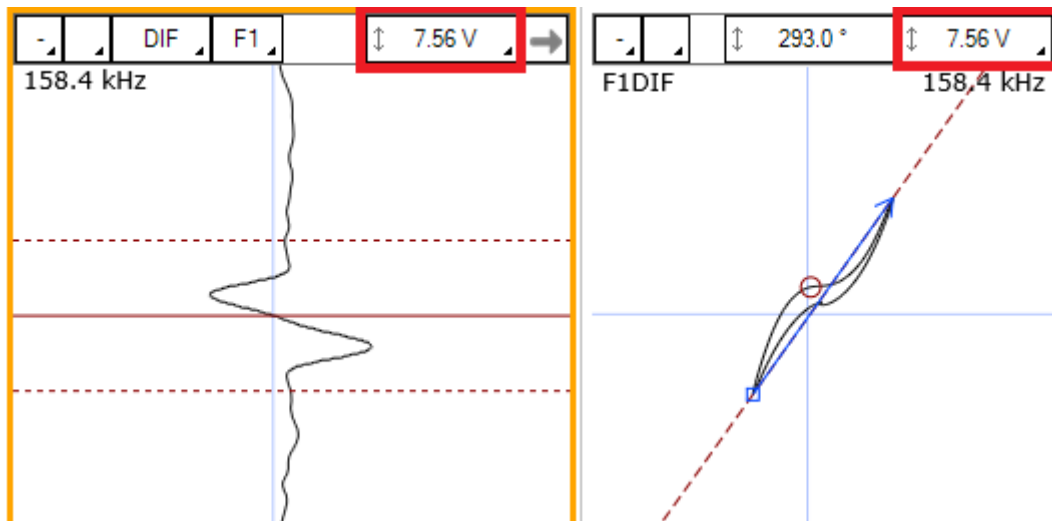

Another way to modify the scale is to click and drag (up or down) the right button of your mouse on the scale button.

## MEASUREMENT METHOD

The buttons at the lower left corner of the Lissajous windows are used to select the measurement method. A short description of the measurement methods can be found in the above calibration section of the setup wizard.



1. Clicking on the corner with the black triangle gives the list of measurement method for the amplitude of the signal. Click on the desired method to select it. Right- or left-click in this button to select the next or the previous method in the list.
2. Same as 1., but for the phase measurement



3. Remove 180° to the measured phase. This option can be used if the software doesn't measure the phase with the right orientation.
4. Take the same two points in time to take the measurement in the other Lissajous
5. Allow a manual measurement of the signal. Click and drag the left button of your mouse to draw a vector in your Lissajous.

## **LISSAJOUS ROTATION AND PANNING**

The signal in a Lissajous can be rotated by holding CTRL on the keyboard while holding the left button of your mouse and dragging it around the rotation axis. Note that this operation cannot be performed on the raw channels since these channels have no gain or rotated applied, by definition. Also, rotating the signal will affect your calibration. If you perform this operation, make sure to recalibrate afterwards.

The origin point can also be moved by holding the left button of your mouse on the Lissajous background and by dragging it in the desired direction.

## **DATA CENTERING**

To center the data in the different windows, put your cursor at a point where you want the data to be centered and use the spacebar on the keyboard.

## CALIBRATION AND SIZING CURVES

---

### FREQUENCY VALIDATION

The injection frequency (set in the *Data definition* section) will influence the phase angle separation between flaws of different depth. It can also affect the signal-to-noise ratio of certain flaws.

If this frequency is too low, the phase angles of your flaws will be close to each other. Therefore, it will be difficult to build accurate sizing curves because a small variation of the phase will lead to a significant change of depth estimate.

Multiple methods can be used to validate that the injection frequency was correctly set. Here's two of them:

- There is approximately 1° per percentage of wall loss between two grooves of different depth. The two grooves must not be too close in terms of depth.
- There is approximately 65° between a through wall hole and a 4 x FBH 20% depth

With Magnifi, the automatic calibration process can also recommend you the right injection frequency. You can go through these steps (described later) before adjusting your frequency.

To adjust the injection frequency:

1. Click on the *Data* button under the *Setup* tab.

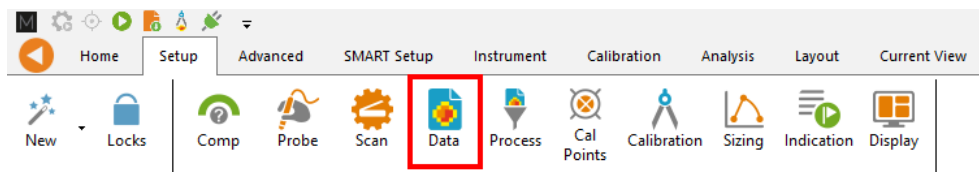

2. To increase the phase angle spread between your flaws, increase the injection frequency. Decrease the injection frequency to lower the phase angle spread. Refer to the figures below for the frequencies to avoid.
3. Click on *Next* and then click on *Finish*
4. Rescan your calibration tube
5. Verify that your injection frequency is right
6. Redo step 1 to 5 until you have an acceptable frequency

### CALIBRATION BASED ON SCALE PROCESS

The following section describes how to calibrate the channels that don't use a voltage plane.

1. Go to the *Calibration* tab and click on the *System* icon.
2. Select Channel in the calibration window.
3. In the Strip chart, select the signal to calibrate and adjust the cursors to see only the desired signal.

Note: The system calibrates the signal with a measurement method that is defined in the calibration part of the setup (previous step). It is recommended to read the data with the same method as the system when you select your calibration point. This will allow you to see what the system is using to make its calibration. If, for some reason, the measurement is not taken properly, you may be able to readjust your cursor to have the right measured values.

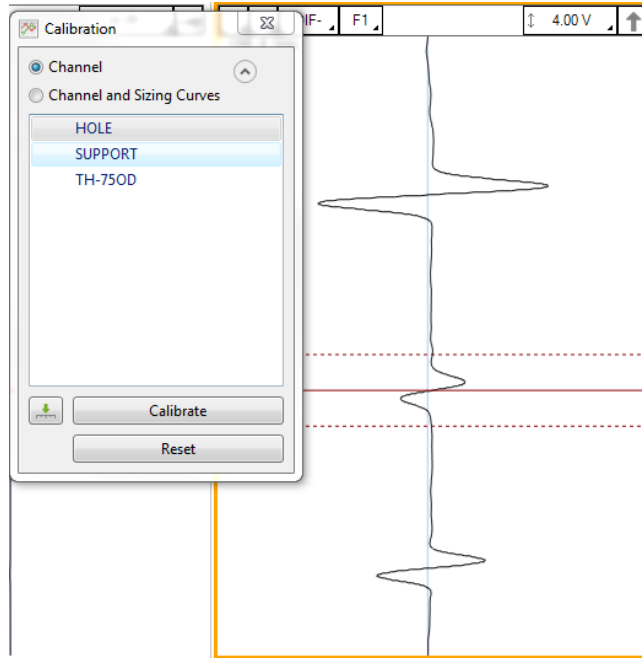

4. Select the signal name in the list.
5. Click on the green arrow button to associate the measured signal to the calibration point.
6. If more than one calibration point is present in the list, redo step 3, 4 and 5 for all of them.
7. When all your calibration points are check marked, click on the *Calibrate* button.

## CALIBRATION BASED ON VOLTAGE PLANE PROCESS

The following section describes how to calibrate the channels that use a voltage plane. Magnifi offers two methods to do this operation.

### MANUAL METHOD

1. Put your cursor in a sound area of your calibration tube.
2. Click on the normalize button in the voltage plane window. This should bring the operation point of the probe to the theoretical nominal point on the Voltage plane.



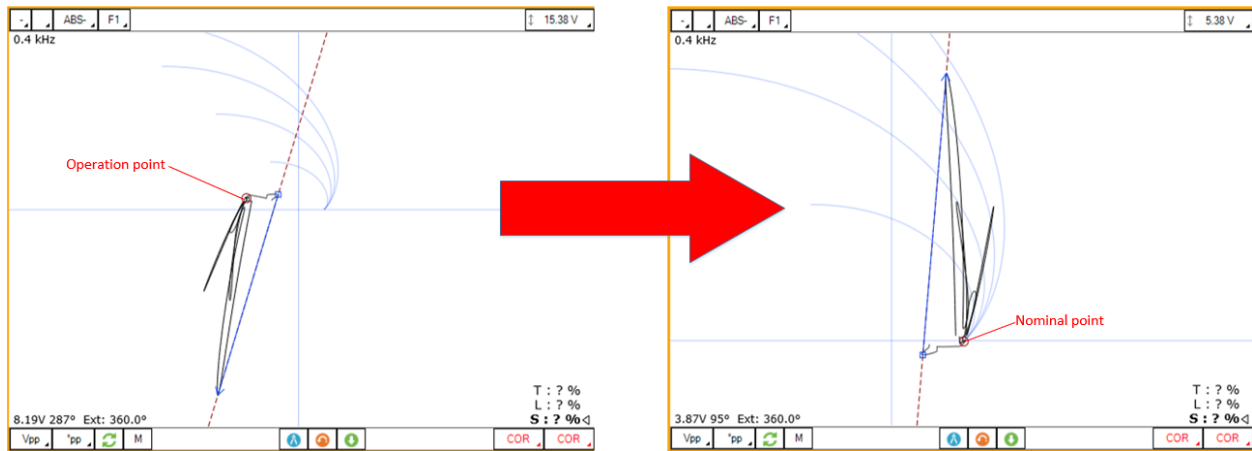

Since this operation depends on how the probe was built, it is possible that the operation point of the probe doesn't reach the theoretical nominal point. If this is the case, right-click on the voltage, click on the *Reset Nominal* button and continue to the next step.

- To adjust the signal manually, Magnifi uses a vector drawn by the user that represents the effect of a completely blocked signal. This vector must start at the operation point of the probe and must go in the direction of the support plate. Its length must initially be set to twice the length of the support plate for a dual driver probe. For a single driver probe, it must be set to the length of the support plate. To draw this vector, click on the manual measurement button " M ", click on the operation point of the signal, hold the left button of the mouse and drag it to the desired location. Once the vector is correctly drawn, click on the normalise button again. Magnifi will put the origin of the vector to the theoretical nominal point. It will apply a gain of  $1/(\text{vector amplitude})$  and a phase rotation of  $-(\text{vector phase})$ . If, for instance, the drawn vector as an amplitude of 0.8 and a phase angle of 10 deg, the system will apply a gain of 1.25 ( $1/0.8$ ) and a rotation of -10 deg to the system.

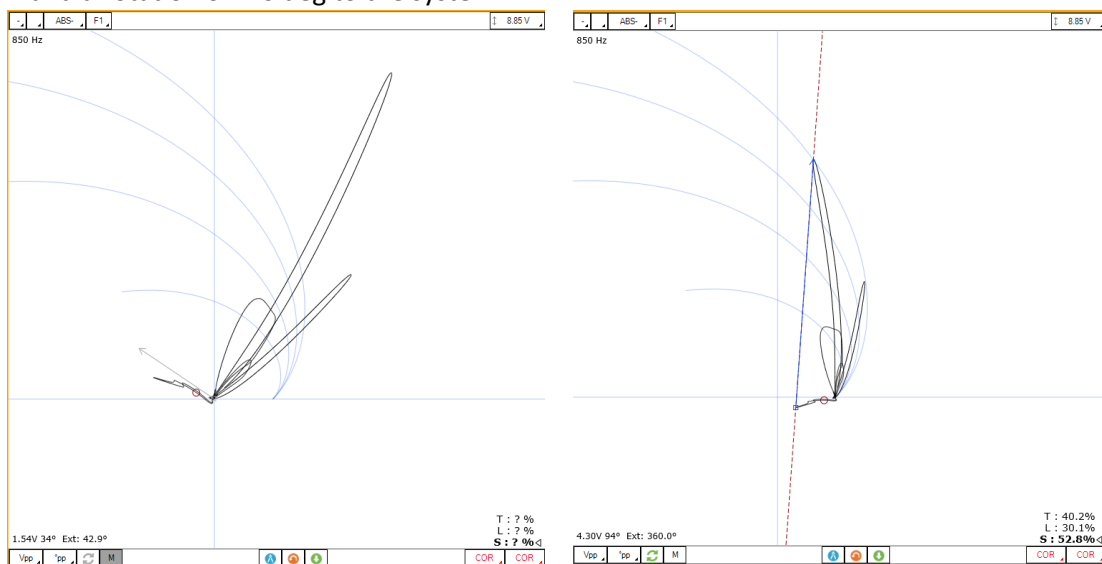

- The signal may not be perfectly adjusted after the previous steps. You can adjust the signal again by drawing a new vector and by clicking on the normalization button until the signal is set

correctly. In the examples below, the calibration tubes included two 360° grooves and we can see that both grooves reach the theoretical 360° coverage line. This can be a relevant indication to determine if a voltage plane is calibrated correctly.

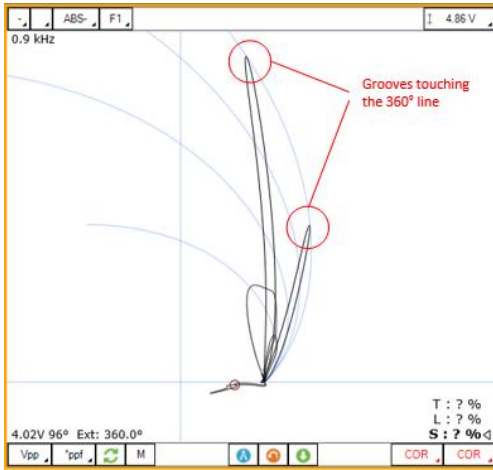

Dual driver probe

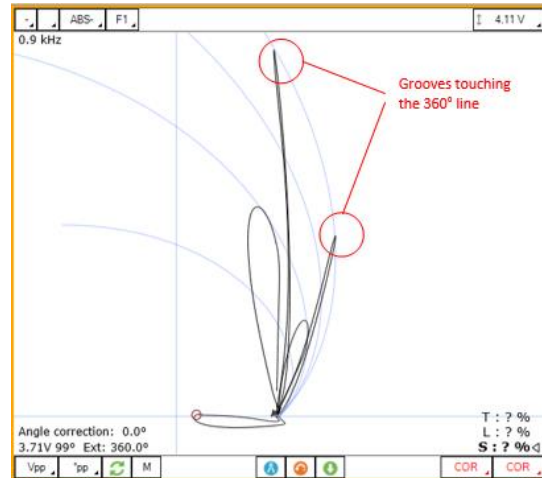

Single driver probe

5. Save your calibration by clicking on the *Save Nominal* button



You can go back to your calibration settings at any time by clicking on the *Back to Nominal* button.



### AUTOMATIC METHOD

Another way to calibrate a voltage plane in Magnifi is to use the automatic calibration tool. This feature requires the following indications:

- One point of type [360°, non-taper] or
- Two points of types [360°, taper] or [non-360°, non-taper]
- A support plate signal
- A nominal point

Also, one point must be 360° and one must be non-taper.

To define the calibration point that will be used by the algorithm, go to the *RFT* tab and click on *Calibration Settings*.

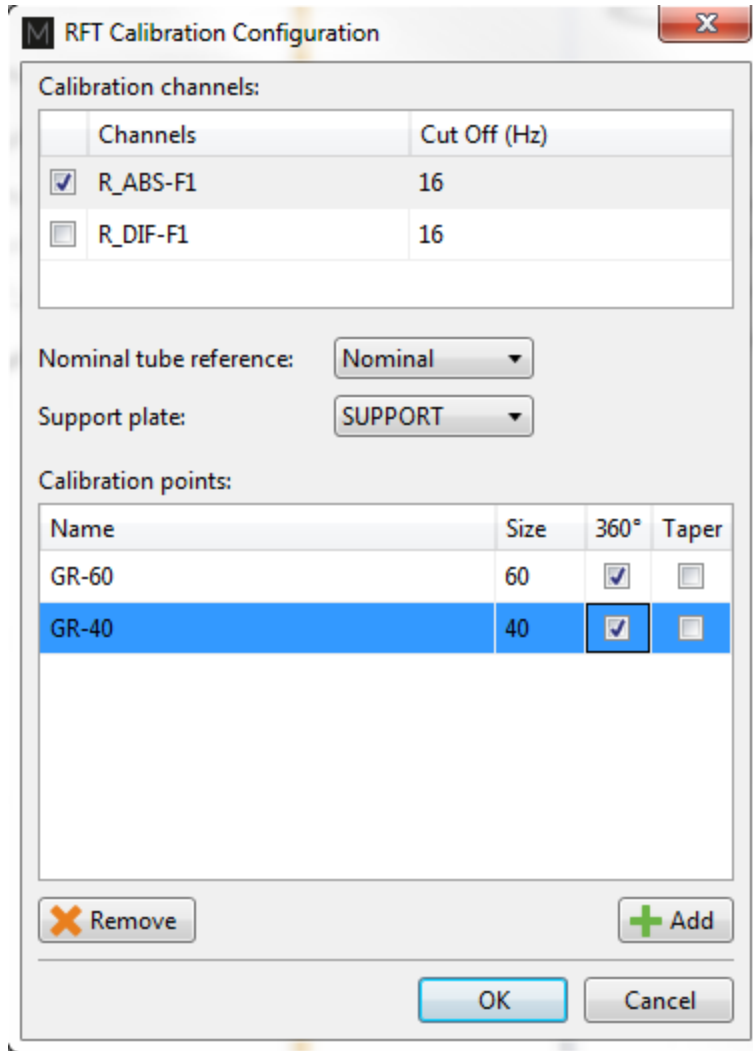

1. Checkmark the raw channel(s) that will be used to calibrate the signal.
2. Select from the drop-down menus the signal name that corresponds to your nominal point and to your support plate (If these signals were not created, you can go back to the *Calibration Points* window via the *Setup* tab).
3. Click on *Add* and select the reference signals that will be use by the algorithm
4. In order to make the algorithm work, the user must associate the calibration points to the real signal. This operation is done at the same time as the sizing curves calibration process. Go to the *Sizing Curves* section of this document and follow the steps using the signals entered previously. This will trigger the automatic calibration.

Tip: For the calibration, when selecting the support plate with a dual-driver probe, it is recommended to take the straight part of the signal that goes from the nominal point to the first signal transition.

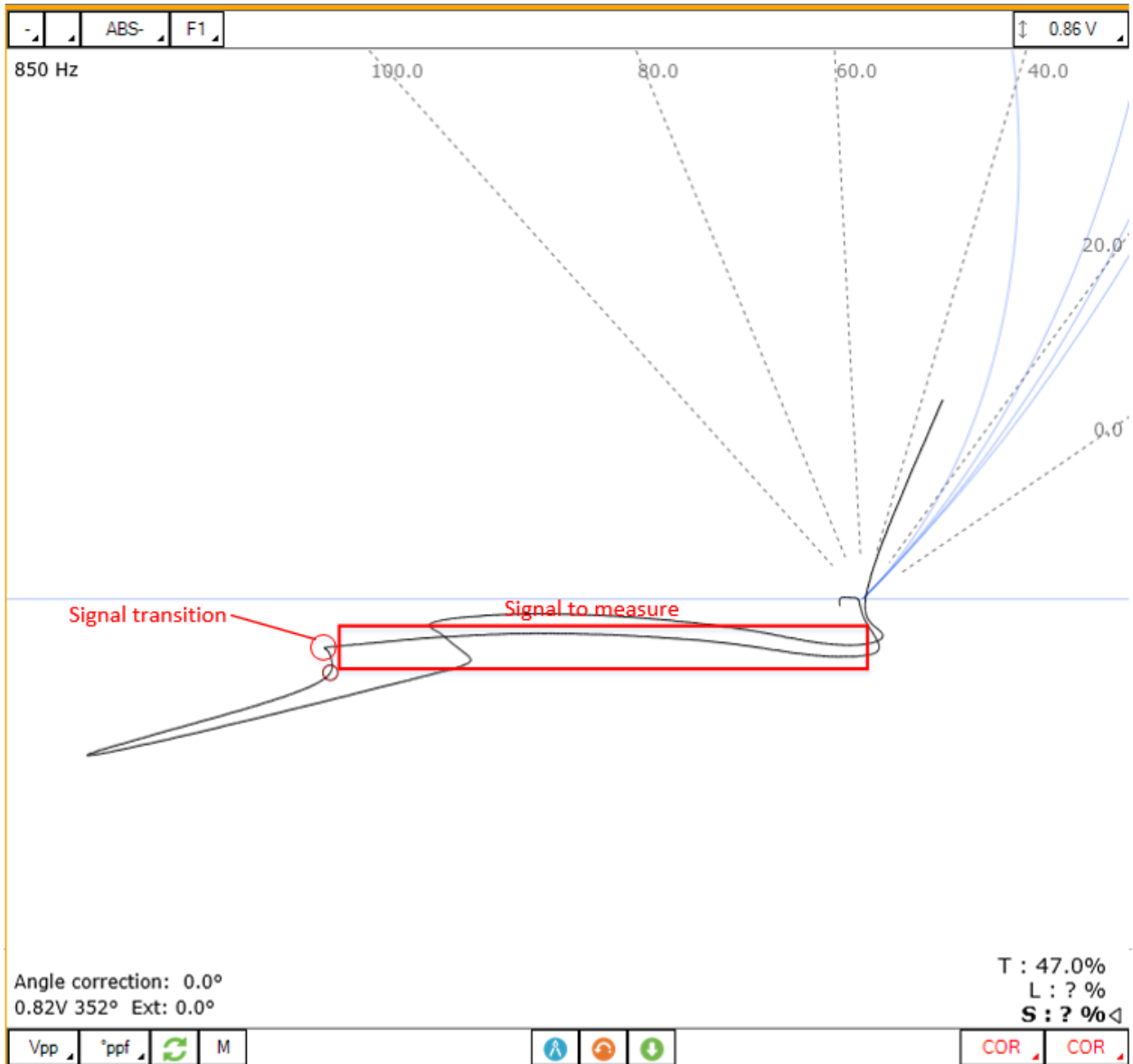

- Once the automatic calibration process is done, the system may recommend you a drive frequency. If this is the case, you can change your frequency, rescan your calibration tube and repeat the previous steps.

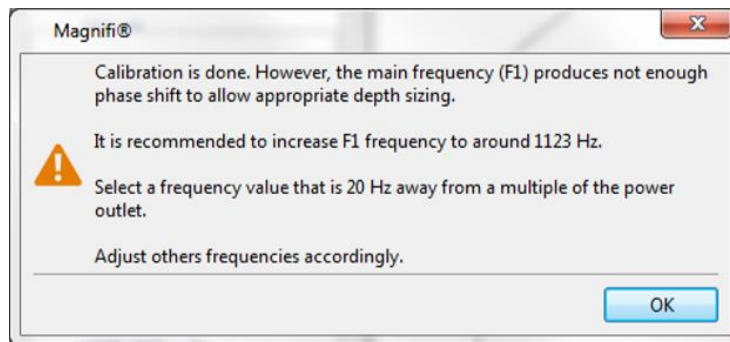

The automatic calibration will give you access to the *Frequency Check* option that can recommend you another inspection frequency in case the inspected tube has properties that are too far from your calibration tube. This feature is shown in the inspection section of this document.

Note that the automatic calibration tool doesn't only adjust the signal to match theoretical curves, but it also dynamically compensates the change of tube properties by recalculating the theoretical curves. This increases the precision of the sizing.

It is possible to use the automatic calibration and the manual calibration on the same setup. The automatic calibration process will create a new channel with which the calibration curves will be readjusted according to a theoretical model. The newly created channel(s) will have the letter " m " (for model) added at the end of the channel name (example: ABSm-F1 for absolute channel with frequency 1).

## NOMINAL POINT VARIATION TOLERANCE

After scanning a tube, you can select a sound point in the data and click on the normalize button in a voltage plane. This will bring this point to the nominal theoretical point. The angle correction will then be shown at the lower left corner of the voltage plane window. It will become red if it's not within an acceptable range. To set this range, click on the voltage plane window, go in the *Current View* tab and enter the value in the *Tolerance* parameter.

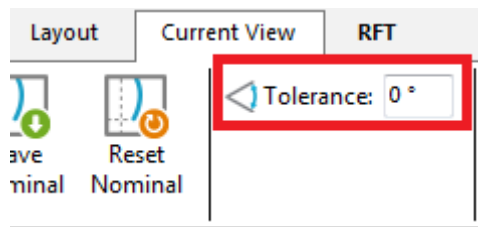

## SIZING CURVES

The following section describes how to build your sizing curves.

1. Go the calibration tab and click on the Sizing curve button
2. Select Channel and Sizing Curves in the calibration window
3. Select the signal in your Strip chart and adjust the cursors to see only the desired portion of the signal.

Note: The system calibrates the signal with a measurement method that is defined in the calibration part of the setup (previous step). It is recommended to read the data with the same method as the system when you select your calibration points. This will allow you to see what the system is using to make its calibration. If for some reason the measurement is not taken properly, you may be able to readjust your cursor to have the right measured values.

Also, when points are entered in the sizing curves, the interpolated value is displayed on the Lissajous to show the defect size. To have the correct interpolated value, the measurement method also needs to be the same as the one used for the sizing curve. To change the measurement method, click on the icons at the bottom left of the Lissajous.



4. Select the associated signal name in the list.
5. Click on the green arrow.
6. Redo the previous steps for all the other indications in the list.
7. Click on the Calibrate button.

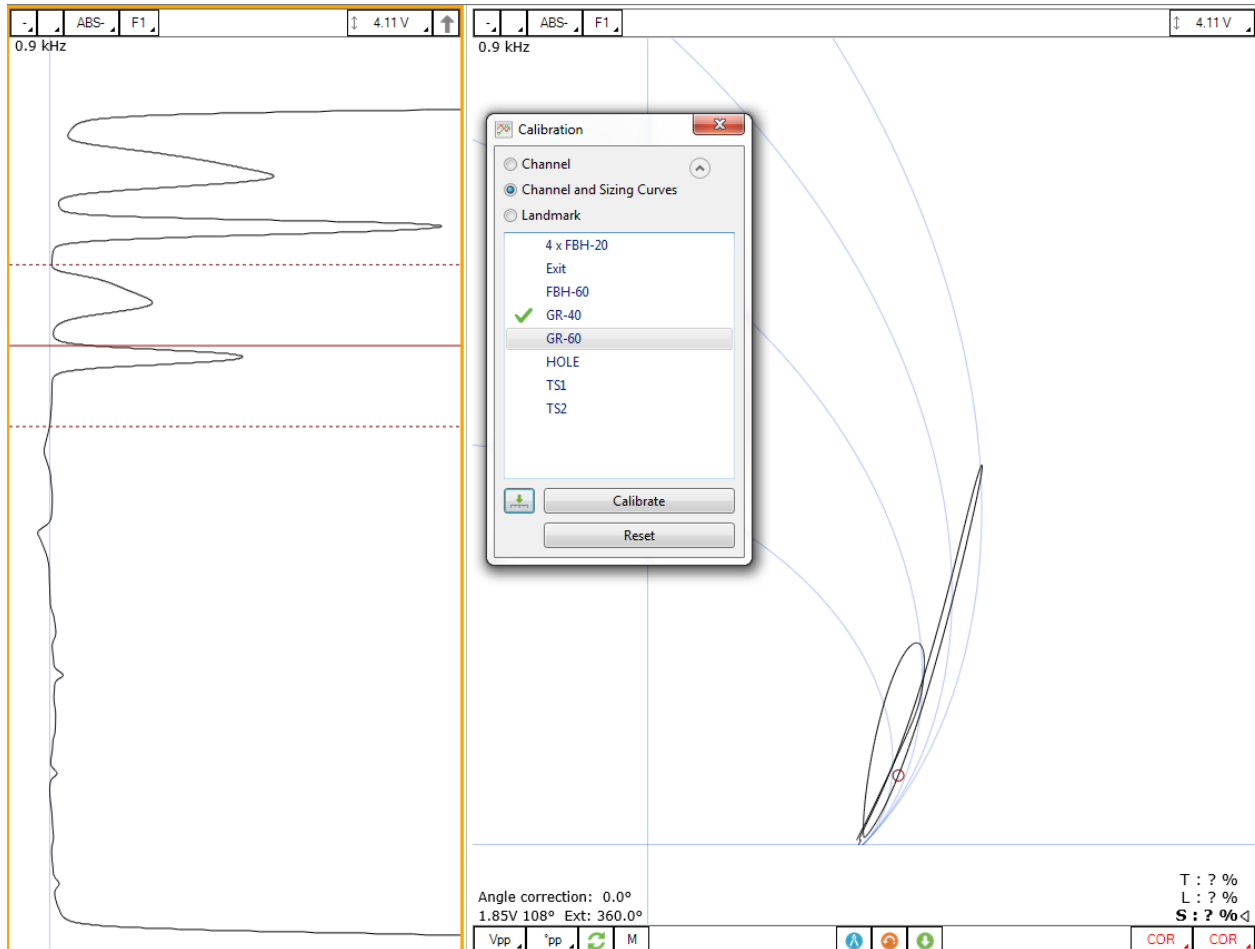

Error messages after creating the phase sizing curves may appear. The main cause of these errors is the measurement direction.

The image below shows two different measurements. On the left, you can see that the measurement arrow is pointing toward the liftoff signal. In this case, the measured phase is rotated of 180° from the right value. When one or more points were measured in the wrong direction, Magnifi cannot build the sizing curve and will generate an error message.

In the image on the right, the arrow is pointing from the liftoff signal to the defect signal, which is correct. However, in this picture, the arrow starts quite far from the middle of the liftoff variation signal, which will cause an error in the measurement. In this case, we suggest you move the cursors until your measurement is taken from a point near the base of the signal.

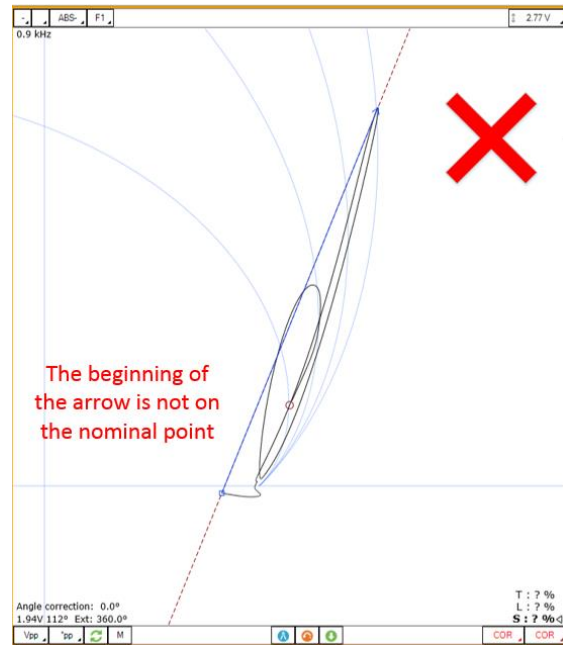
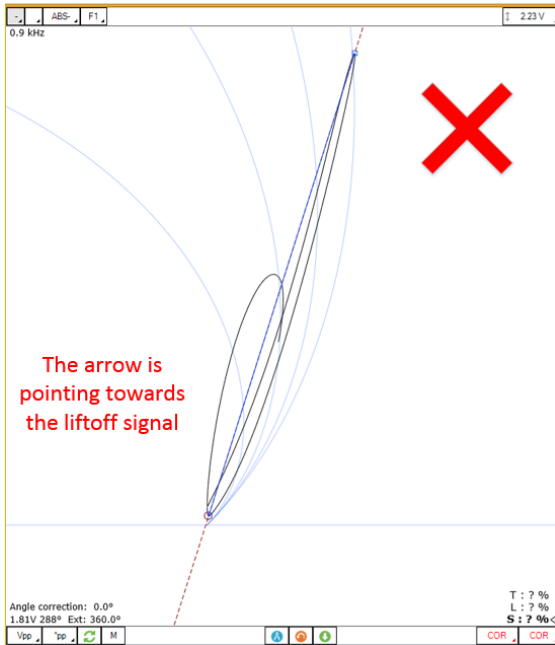

To adjust your sizing curves and remove the error messages, go the *Calibration* tab, and click on *View Curves*.

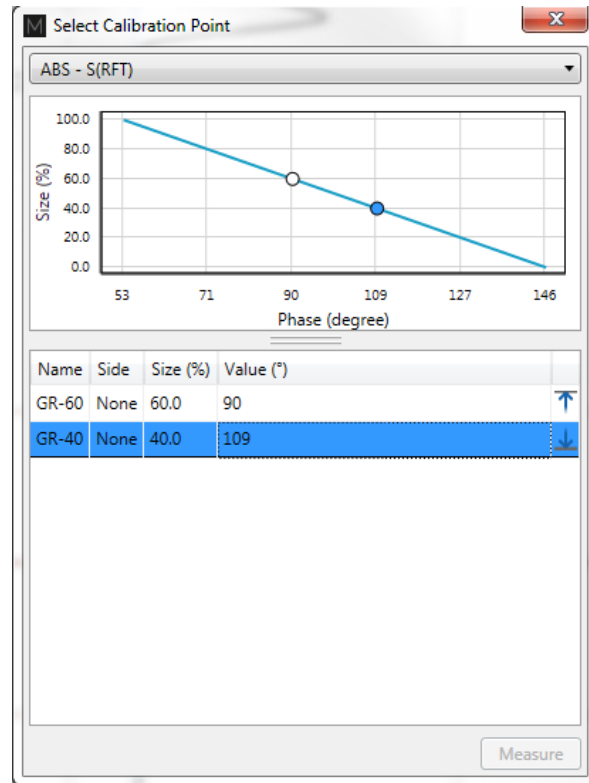
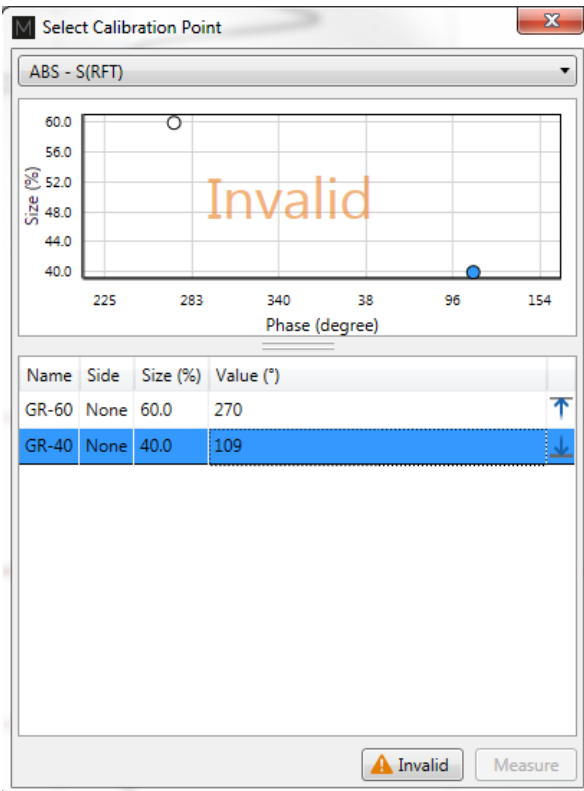

The sizing curve window will appear. Each sizing curve you asked Magnify to create will be listed in the drop-down menu. If an invalid notification is present on the curve, it means that you either haven't entered the sizing points yet, or that Magnifi failed to create the curve. To adjust the sizing curve manually, enter the value in the table.

In the above example, the entered phase angle for the 40% groove is 270°, but the correct phase angle is 90°. The defect has an 180° bias due to an incorrect measurement direction. In this case, we can simply change the angle value from 270° to 90° in the table to fix the sizing curve.

To validate the curves, you can bring the measurement cursor over one of the calibrated flaws in the Lissajous and get an estimation of the depth (shown in the lower right corner). If the flaw size does not appear, it means that you are not in a channel where a sizing curve was set.

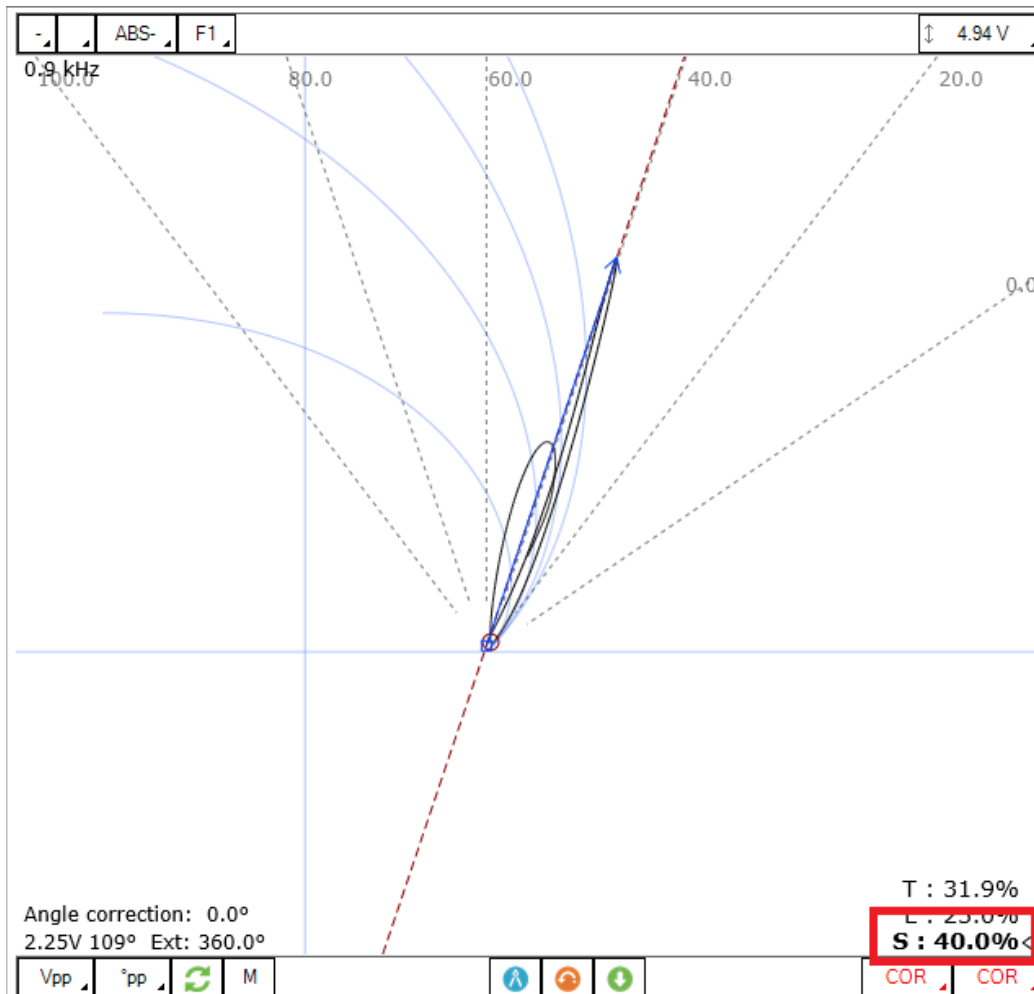

Built sizing curves can give you access to the phase-depth indications on the Lissajous and the Strip Charts. To activate this option, click on a window (Strip Chart, or Lissajous), go to the *Current View* tab and check the *Depth-P* option.

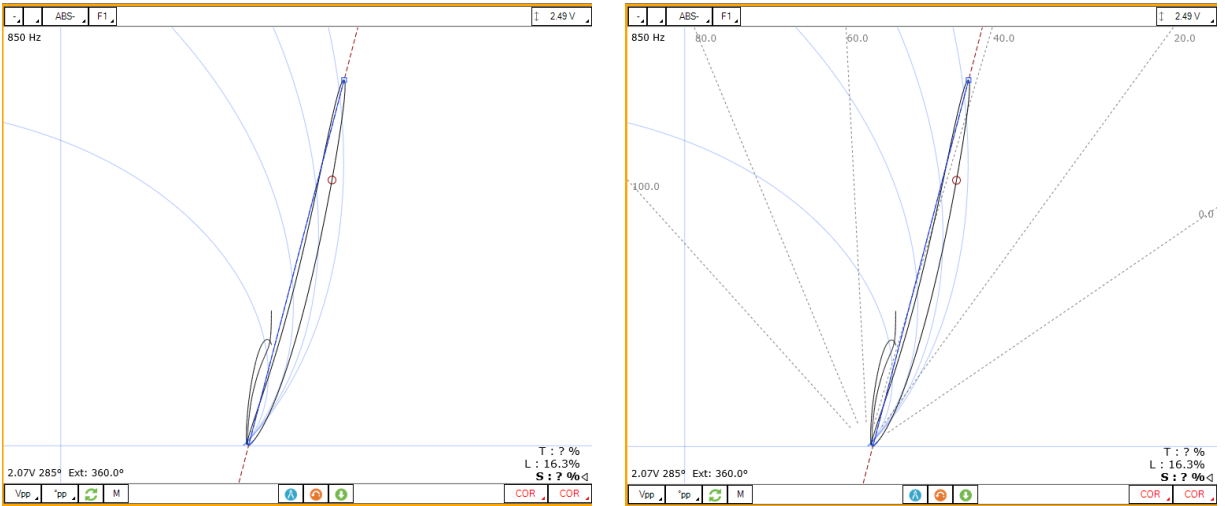

## LANDMARKS

The following section describes how to calibrate your landmarks.

Go to the calibration tab and click on the Landmark icon. Calibrate the landmarks shown in the *Landmarks* window the same way you calibrate the sizing curve(s) points. You can use the *Land* channel to do so. The positions of TS1 and TS2 are described in the *Landmark* window in the *Setup* tab (TS2 is the farside tubesheet, that is, the first one encountered by the probe during data acquisition; TS1 is the nearside tubesheet).

Once the landmarks are calibrated properly the system should be able to recognize them automatically.

Note that in order to calibrate the default *Exit* landmark, a datafile that includes the probe exit at the far end of the tube is needed.

## SAVING YOUR SETUP

Once all your setup adjustments are done, you can save your setup by clicking on the *Save Setup* button under the *Home* tab. The displayed window will allow you to give an appropriate name to your setup and to save it at the desired locations. The save location is, by default, your inspection file. Note that when a data is saved, the setup is also saved with it.

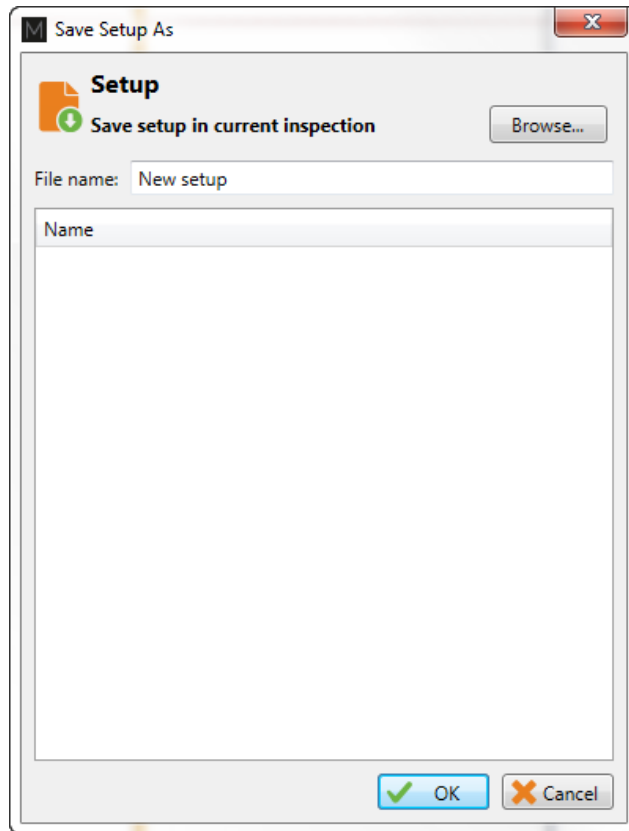

You can also save the data of your calibration standard by clicking on the *Save As* button under the *Home* tab.

## INSPECTION

---

### STANDARD ACQUISITION

The following section describes how to perform an inspection.

1. Connect Magnifi to your instrument.
2. Enter into *Acquisition Mode* by clicking on the *Setup Mode* button under the *Home* tab. *Acquisition Mode* is activated when the *Setup Mode* button is not grayed.
3. Plug the RFT probe into the Ectane 19-pin connector.
4. If you wish to balance, bring the probe head to a clear area in your standard and balance the probe by clicking on the *Null* button under the *Home* tab, or press F6 on your keyboard.
5. Push the probe all the way through the tube until it exits the far end and start the acquisition by clicking on the *Acquire* button under the *Home* tab or by pressing the F2 on your keyboard.
6. Pull the probe towards you at a constant speed until it exits the tube.
7. When finished, press the *Stop* button or again F2 on your keyboard.
8. Repeat steps 4,5,6 and 7 for all the tubes to inspect in your bundle.

## MANUAL SEQUENCE

An inspection can also be done by using the manual sequence. This feature is based on the landmarks and can trigger the acquisition start/stop and the data recording automatically. At least two landmarks are needed to use this feature. These landmarks can be created by using the Landmarks button under the SMART Setup tab.

To set the manual sequence:

1. Click on the Manual Sequence button under the Calibration tab.
2. If a warning message is shown in this window, change the parameters until no warnings are shown. The system will progress through the different windows to guide you.
3. Click on Settings ...

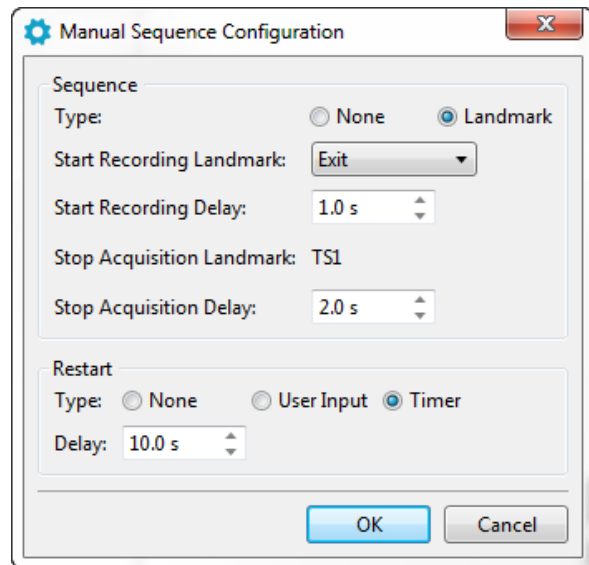
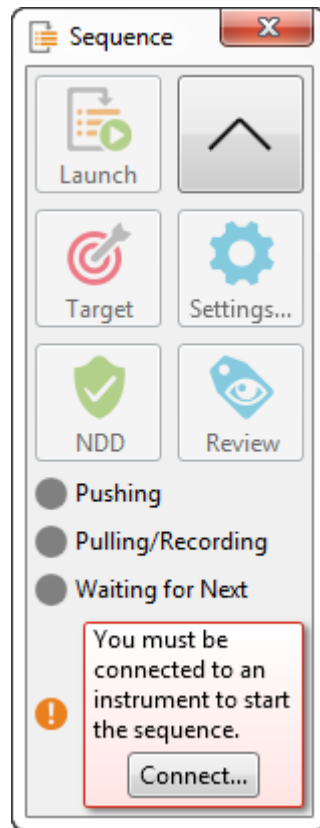

4. Select *Landmark* in the *Type* section.
5. In the drop-down menu choose the Landmark that will initiate the data recording. If you keep the default landmarks, you can select the *Exit* landmark that will be triggered when the probe goes out of the tube when the probe is pushed.
6. You can enter a delay to start the acquisition after the first landmark is detected (*Start Recording Delay*) and a delay to stop the acquisition when the last landmark is detected (*Stop Acquisition Delay*).

7. Two options are available to restart the acquisition: The user can either push a button or use a timer. Select the desired option in the *Restart* section.
8. Click on *OK*.

To use the manual sequence:

1. Connect Magnifi to the instrument
2. Enter into *Acquisition Mode* by clicking on the *Setup Mode* button under the *Home* tab. The *Acquisition Mode* is activated when the *Setup Mode* button is not grayed.
3. Plug the ECT probe into the Ectane 4-pin connector.
4. Bring the probe head to a clear area in your standard and balance the probe by clicking on the *Null* button under the *Home* tab, or press F6 on your keyboard.
5. Open the *Sequence* window by clicking on the *Manual Sequence* button under the *Calibration* tab.
6. Put your probe in the tube to inspect and click on the *Launch* button. This will start the data acquisition.
7. Push the probe until it exits the far end of the tube. If set correctly, Magnifi will recognize the landmark and this will initiate the data recording.
8. Pull the probe towards you until it exits the tube. This will trigger the last landmark detection that will stop the data recording.
9. Acquisition restart:
  - a. If you selected *User Input* in the settings of the *Manual Sequence Configuration*, the system will wait for the user to enter information on the tube to restart the acquisition. Click on *NDD* or *Review*. This will add a tag to the inspected tube and it will restart the acquisition. Repeat steps 6, 7 and 8a. for all the tubes to inspect
  - b. If you selected *Timer* in the settings of the *Manual Sequence Configuration*, a countdown will trigger after the last tube acquisition was taken. The acquisition will start after this time has elapsed. Redo step 6 and 7 for all the other tubes to inspect in the bundle.

When doing your inspection, you may encounter some tubes that can't be scanned completely. If this is the case, you won't be able to catch the landmark that triggers the data acquisition at the end of the tube. In this situation, you can click on the *Target* button in the *Sequence* window to start the data recording.

## DATA LIST MANAGEMENT

For each acquisition, Magnifi can automatically save a file using the file name defined previously in the *Tube list* section of this document. To do so, checkmark the *Automatic File Recording* option that can be found under the *General tab* of the *Preference* menu of the *Backstage*.

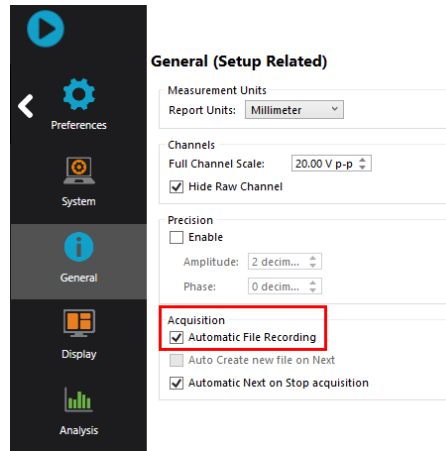

The list of tubes is also shown in the *Data* window.

Row	Col		
✓	101000001	20	8
✓	101000002	9	8
✓	101000003	10	8
✓	101001001	16	
✓	101001002	9	
✓	101002001	11	
✓	101002010	14	
✓	101004005	5	

A common practice is to rescan your calibration tube and balance the tube periodically. You can save this new calibration tube data by adding a new tube in your tube list (999 001 for example). Or you can go out of the acquisition mode, scan your tube, and click on the *Save Cal As...* button under the *Calibration* tab to save your data. You can then go back to *acquisition mode* to continue your inspection and to automatically save the acquired tubes in your bundle.

Once a tube has been scanned, the "play" icon next to the file name will be replaced with a checkmark icon.

You can rescan a tube by selecting its name in the list and by clicking on the *Rescan* button in the *Home* tab.

A TUBE NAME CAN BE CHANGED BY RIGHT-CLICKING ON ITS NAME AND BY SELECTING THE RENAME OPTION.

## FAST NORMALIZATION SETTINGS

The opened data may not have been already adjusted to match your sizing curves. Magnifi offers a tool to do these adjustments in an efficient way.



Go the *RFT* tab and click on the *Settings* button. The displayed window will show the channels using voltage planes and standard scale process.

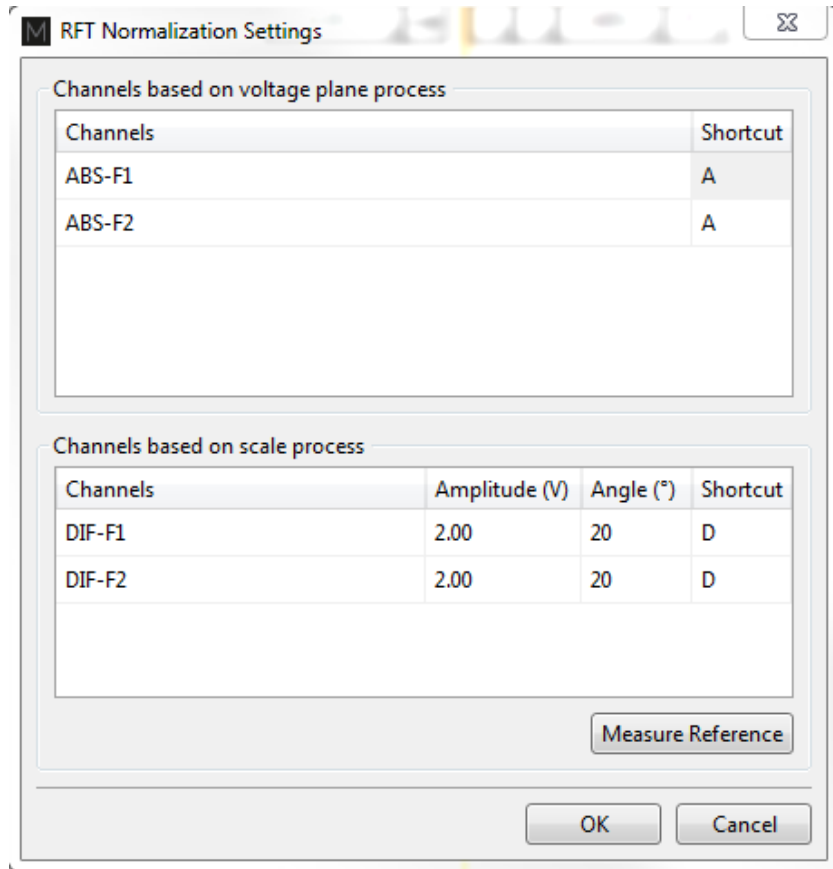

The channels using a standard scale process will only be shown if the option to link the differential channels to the absolute was not selected in the *Calibration* part of the setup wizard.

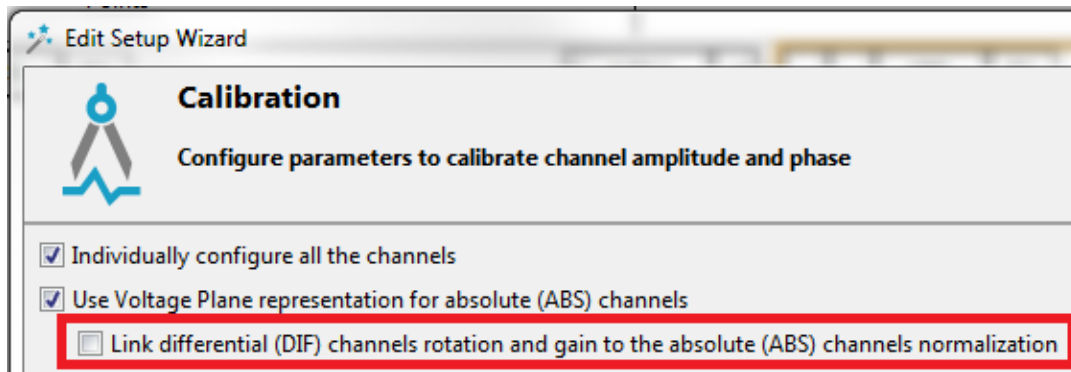

Keyboard shortcuts next to the channels can be customized to normalize the associated channel. To normalize the process using a voltage plane, select a sound area in the tube and push on the keyboard shortcut. To normalize the channels using a standard scale process, select the reference (normally a support plate) and click on the keyboard shortcut. The system will adjust the selected reference to the value set in the *RFT Normalization Settings* window (*Amplitude* and *Angle*).

## LOADING A FILE

1. First disconnect your computer from the Ectane by clicking on the *Disconnect* button under the *Home* tab.
2. You can load a file by double-clicking on the file name in the *Data* window. It can also be done by selecting the file in the list and by clicking on the *Load* button under the *Home* tab. Note that double-clicking on a tube when you are still connected to an instrument will initiate data acquisition.
3. You can open the next or the previous file in the list by clicking on the *Previous* or *Next* button of the *Home* tab.

The data files can be filtered by using the *Filter* button of the *Data* window.

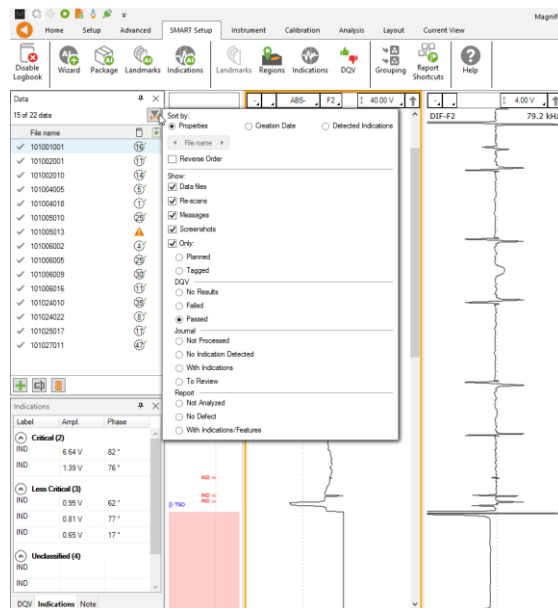

## REPORT

### INDICATIONS

The two *Indication* buttons at the lower corner of the Lissajous windows can be used to add an entry to the report. These two buttons indicate the code that is associated with the defect being entered. Both buttons are identical, but can be set to identify different flaws.

To add an indication to the data:

1. Select the defect signal in the strip chart and adjust the cursor so that the signal in the Lissajous includes only the defect signal.
2. Then, click on the red triangle in the corner of the *Indication* button to select the type of defect to enter.
3. Click on the defect button to add an entry to the report.

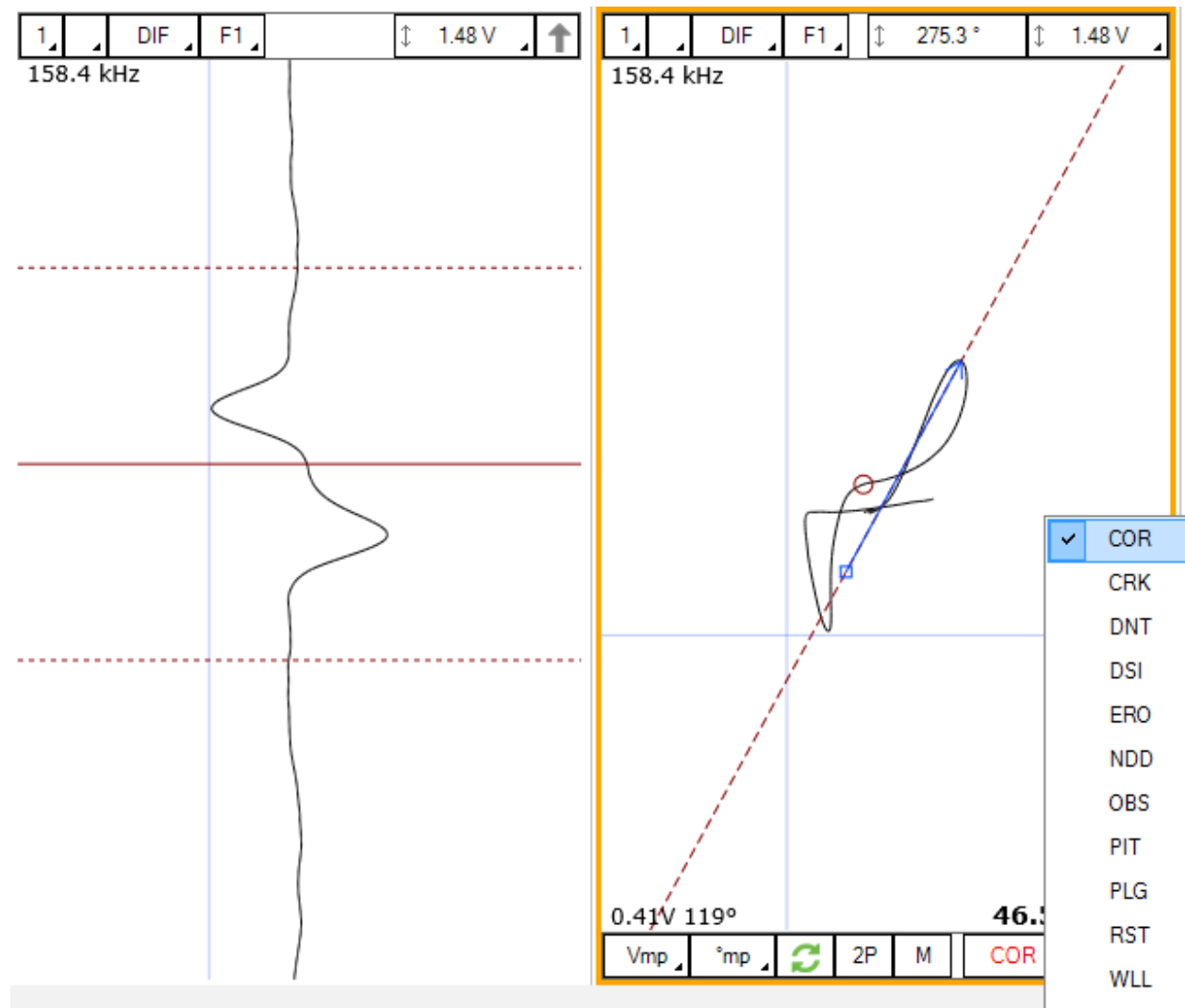

Report Entries can also be added with keyboard shortcuts. How to set up these keyboard shortcuts is explained in the SMART Setup section of this manual.

Indications can also be added to a tube to indicate, for instance, that it has no flaw or that it is plugged.

To add an indication to a tube:

1. Load the file
2. Click on the appropriate indication button available under the Analysis tab

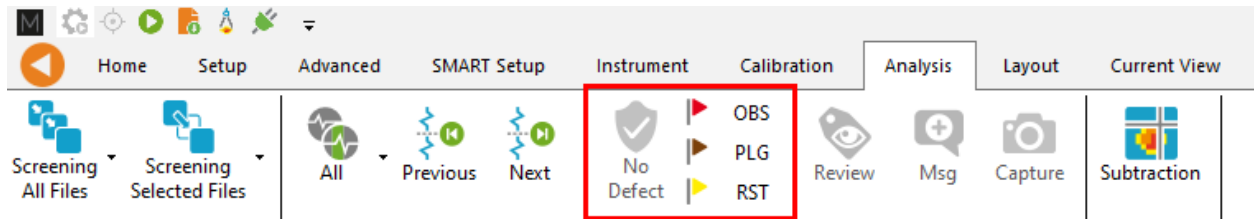

## REPORT TABLE

To access the list of detect entered:

1. Make sure that the Report option is selected under the Layout tab.

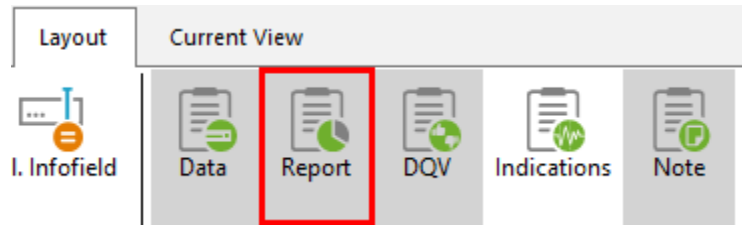

2. Click on the report ribbon at the bottom of the screen to make the list visible

Zone	Row	Col.	Code	Size	Side	Ampl. (V)	Angle (°)	Channel/C-scan	Y pos. (mm)	LMKY pos.	Offset Y pos. (mm)	Y leng. (mm)	Comment
1	0	0		0.00		0.00	0		0.0		0.0	0.0	X
2	0	0		0.00		0.00	0		0.0		0.0	0.0	X

Entries in the report can be modified by changing the value in the table. You can also delete an entry by clicking on the X next to it.

## REPORT GENERATION

Magnifi can automatically generate a full report with the report table.

To generate this report:

1. Go to the *Backstage* by clicking on the arrow at the upper left corner of the *Frontstage*.
2. Click on the *Generate Report* button under the *Report* section of the *General* tab.
3. Choose your preferences and enter the required parameters. The *# of tubes in component* is used to show the percentage of tube in each category.

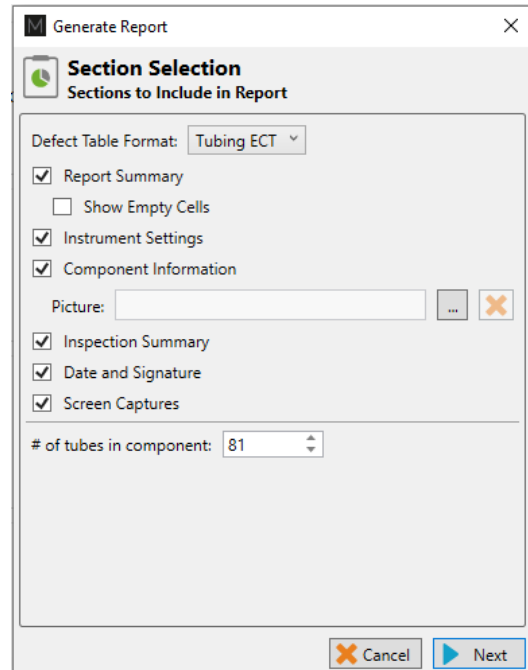
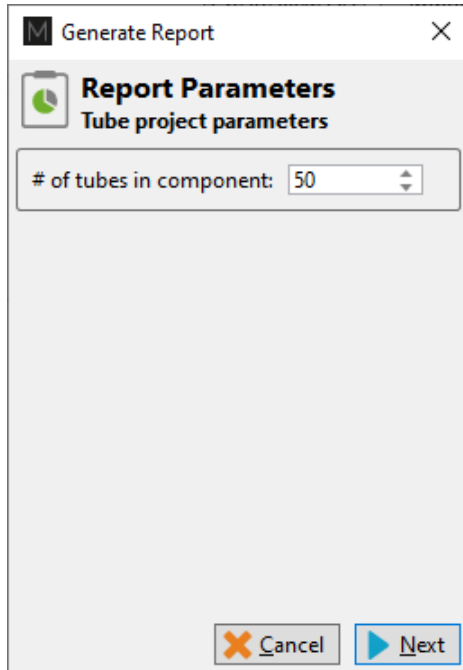

4. Click Finish to generate the report.

Once generated, the report is saved as a .html file in the current Inspection sub-directory. It can be viewed using any regular web browser.

There is a “copy” button next to each element of the report such as tables and images. When clicking on it, the element will be copied to the clipboard. It can then be pasted to another file such as an Excel or Word.

Name	Frequency (KHz)	Drive (V)	Gain (dB)	Low Pass (KHz)	High Pass (Cnt)
R_ABS-F1	160.0	2.50	46.0	400	
R_ABS-F2	80.0	2.50	46.0	400	
R_ABS-F3	40.0	2.50	46.0	400	
R_ABS-F4	20.0	2.50	46.0	400	
R_DIF-F1	160.0	2.50	46.0	400	
R_DIF-F2	80.0	2.50	46.0	400	
R_DIF-F3	40.0	2.50	46.0	400	

The Print button, bottom right corner on image above, can be used to either print a paper copy of the whole report or to save it as a .pdf document. The PDF generator available with the current web browser will be used.

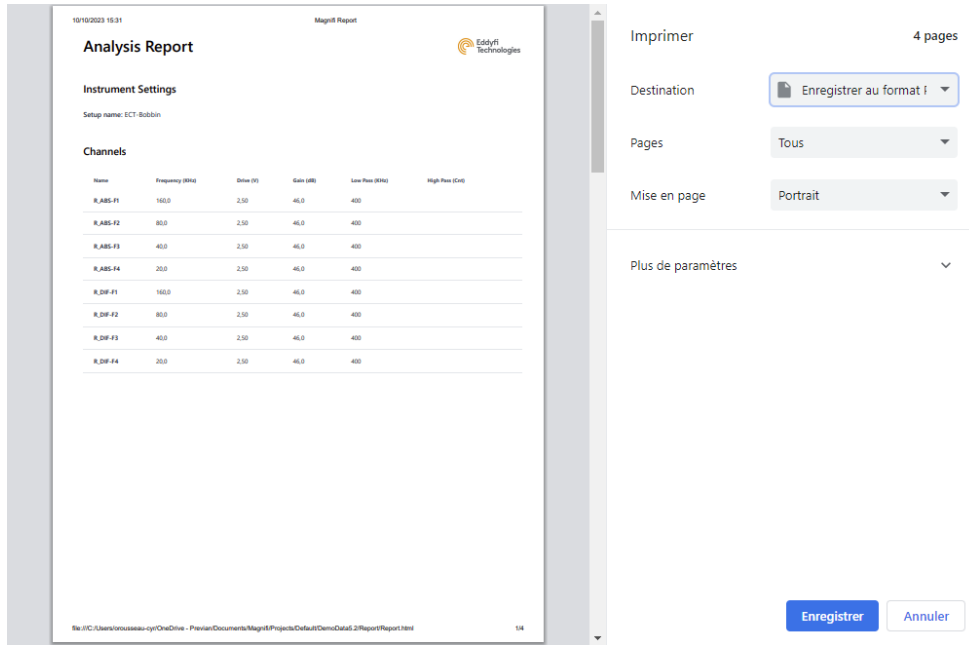

The report logo can be modified by clicking on the *Select Company Logo* that can be found under the *System* tab of the *Backstage*.

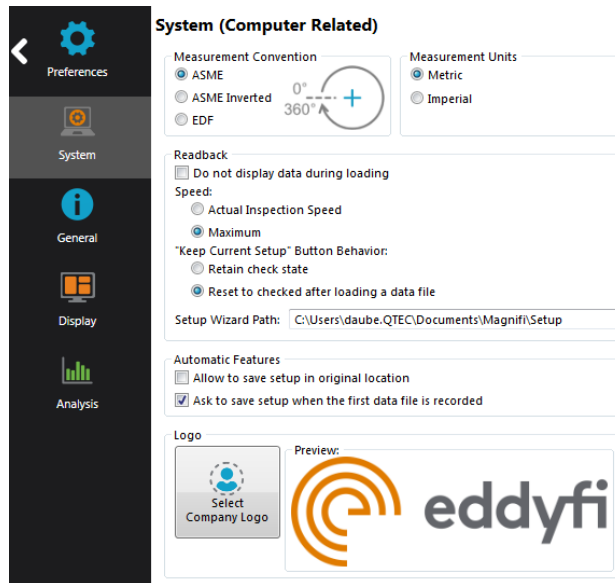

The report table file in the *Inspection* folder can also be imported into other reporting software such as *TubePro*.

## APPENDIX 1 – VOLTAGE PLANE

---

The two following equations describe the through-wall transmission behavior of RFT:

$$B = B_0 e^{-\phi} = B_0 e^{-d \sqrt{\pi f \sigma \mu_0 \mu_r}}$$

$$\phi = d \sqrt{\pi f \sigma \mu_0 \mu_r}$$

$B$  = Magnetic field strength at a depth corresponding to phase lag ( $\phi$ )

$B_0$  = Initial magnetic field strength

$\phi$  = Phase lag

$\phi$  = Phase lag

$\mu$  =  $\mu_0 \mu_r$  = Permeability

$d$  = Thickness

$f$  = Frequency

$\sigma$  = Conductivity

The phase lag equation shows that the signal is influenced by the tube properties ( $d$ ,  $\sigma$ ,  $\mu$ ) but

also depends on the frequency ( $f$ ) at which the tube is inspected. Given a tube of constant permeability and conductivity, and using a fixed inspection frequency, the phase lag will be proportional to the thickness of the tube.

The magnetic field strength ( $B$ ) will depend on this phase lag. For an infinite theoretical thickness, the resulting magnetic field will be null. The explanation being that the field is completely blocked and that nothing is caught by the receiver(s).

The voltage plane is a graphical representation of these formulas. The curves built on a voltage plane show the effect of the thickness variation on the signal. There are four curves that represent a flaw coverage of 90°, 180°, 270° and 360°. The point crossing the horizontal axis is the nominal point. This is the signal obtained when the probe is in a sound area of the tube. It has an amplitude of 1V and a phase of 0°.

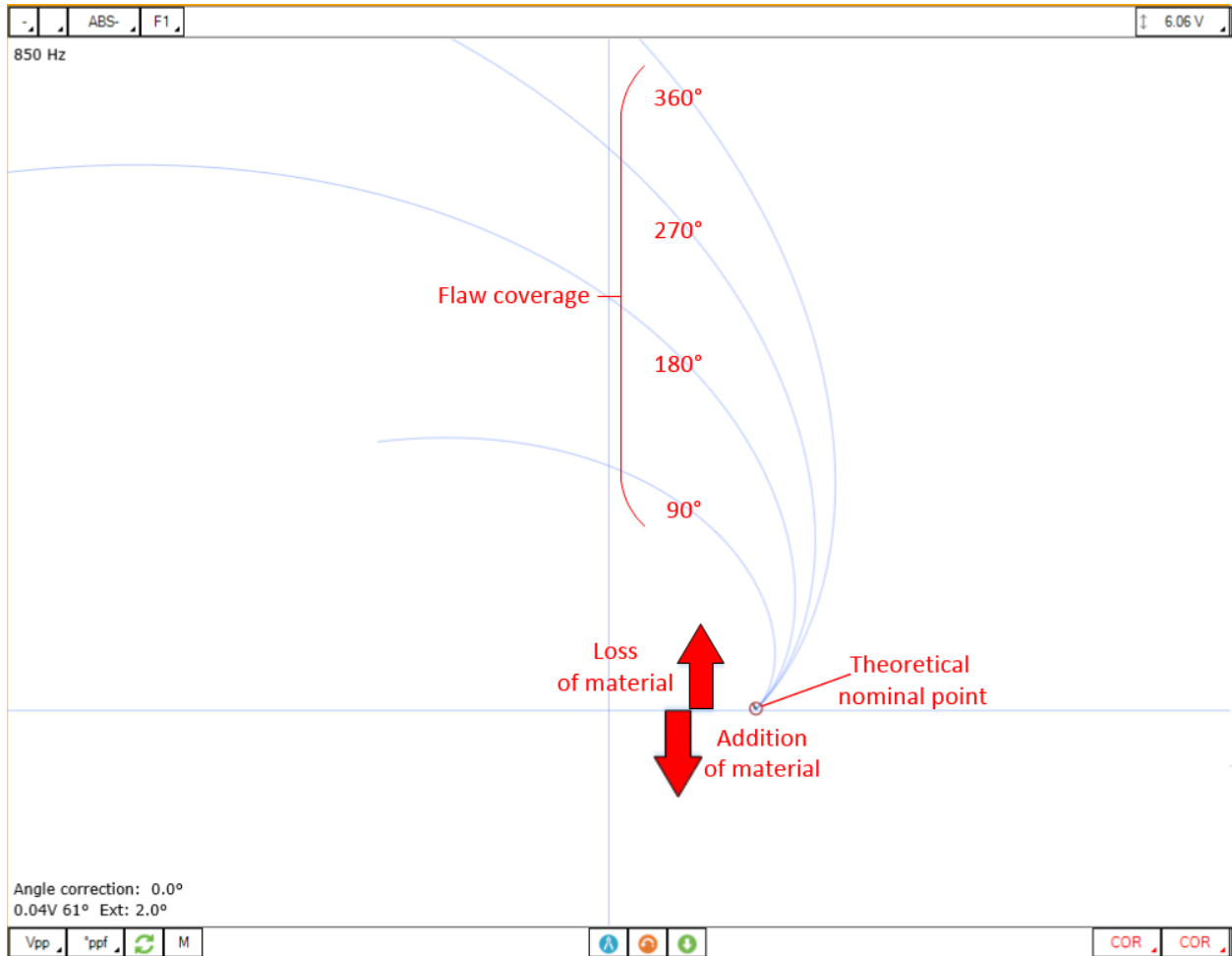

When you first scan your calibration tube, this point doesn't match the nominal point of your theoretical curve. You must calibrate the signal to match your probe signal to the theoretical curve(s). This operation is called normalization.

A bundle of tube may include tubes that have different properties. The permeability, for example, may be different for some tubes. This will affect the nominal point position and the built sizing curves won't be applicable to this tube.

If the nominal point moved not too far from the theoretical nominal point, the common practice is to renormalize and to size the flaw with the built sizing curves.

If the nominal point moved far from the theoretical value, it means that the tube properties are significantly different from the calibration tube. Therefore, the phase lag for a given flaw will also be significantly different and this will generate an error in the sizing that must be considered. In this case, it is recommended to change the drive frequency to put the nominal point back to the renormalization zone.



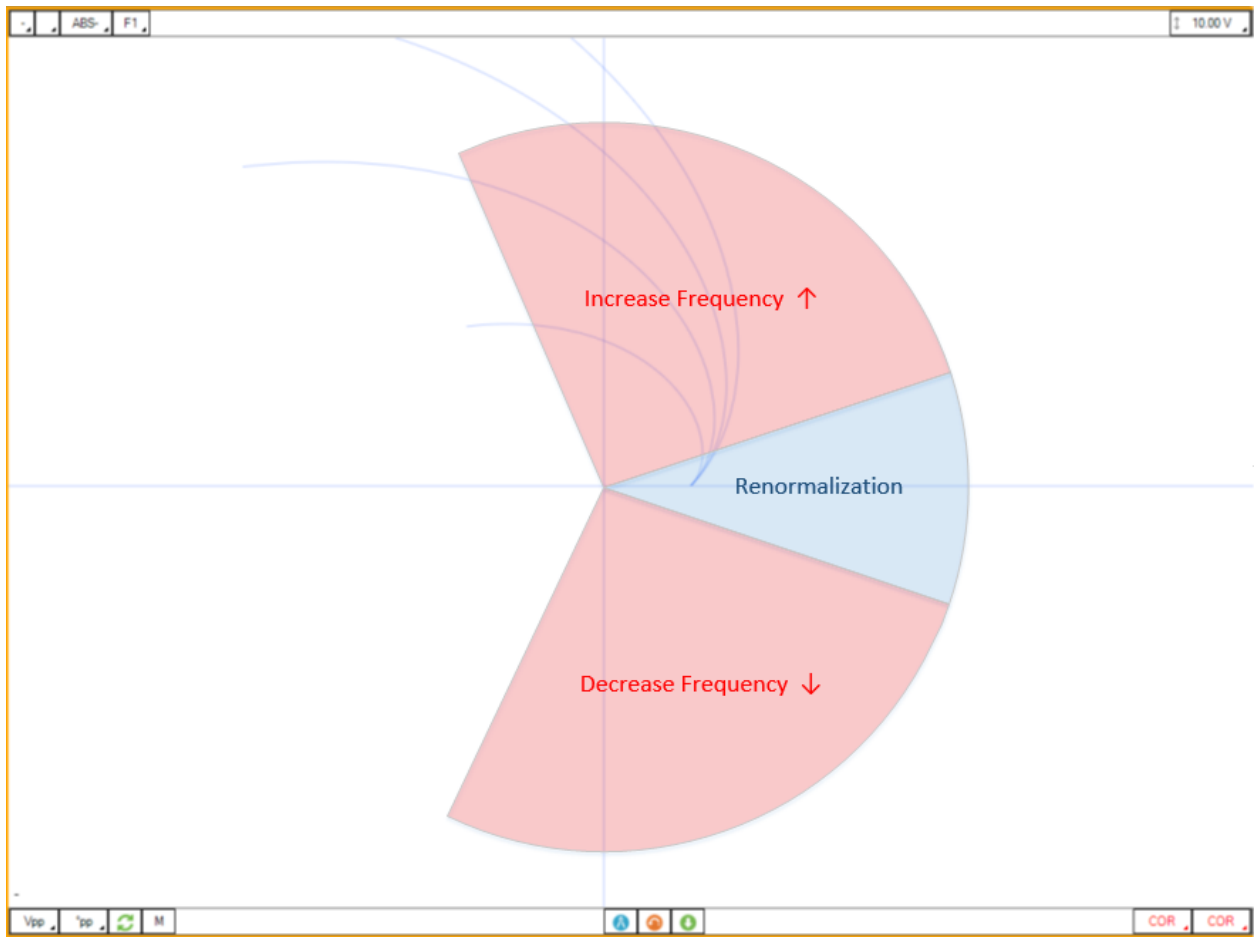

A common practice is to set the threshold angle at which the inspection frequency needs to be changed to 30°.

# RFA Application Guide



## INTRODUCTION

This document presents how to use an RFA probe with Magnifi 5.1 on an Ectane 3 instrument.

## EQUIPMENT

The RFA probes use a 41-pin connector that can be connected to an Ectane 3 with the "E64RNM" or the "E128RNM" option.

Magnifi acquisition and analysis software version 5.1 or greater must be used. A license allowing for tubing array techniques is required.

Possible probe diameters are offered from 11.0 mm to 23.0 mm in 0.5 mm increments. It is recommended to use the largest diameter possible. This will decrease the lift-off and improve performance. You can refer to the table below for the recommended diameters depending on the size of the tube to be inspected.

The center frequency of the probe is 300 Hz and it should be used with frequencies ranging from 50 Hz to 2 kHz.

From the following table, the best probe for your application can be selected.

Probe Diameters

		TUBE WALL THICKNESS															
		BWG	4	5	6	7	8	9	10	11	12	13	14	15	16	17	18
mm			6.05	5.59	5.16	4.57	4.19	3.76	3.40	3.05	2.77	2.41	2.11	1.83	1.65	1.47	1.24
in			0.238	0.220	0.206	0.180	0.165	0.148	0.135	0.120	0.109	0.095	0.083	0.072	0.065	0.058	0.049
TUBE OD	15.87	0.625	-	-	-	-	-	-	-	-	-	-	-	110	110	115	120
	19.05	0.750	-	-	-	-	-	-	110	115	120	125	130	135	140	140	145
	22.22	0.875	-	-	-	115	120	130	135	140	145	155	160	165	165	170	175
	25.40	1.000	115	125	135	145	150	160	165	170	175	180	185	190	195	200	200
	31.75	1.250	175	180	190	200	205	215	220	225	230	-	-	-	-	-	-

The RFA calibration tube used in this document includes the following machined defects and features:

- External grooves, 20%, 40% and 60% of wall loss
- Flat bottom hole, 60% of wall loss
- Hole, 100% of wall loss
- A support plate

## RFA PROBE DESCRIPTION & CHANNELS

The RFA probe includes 2 drivers at each end of the probe head. The driver on the cable side is named the Lead since it is the first to pass under the defects and features when the probe is pulled through the tube. The second driver is called the Trail.

The probe includes 2 circumferential bobbin coils that create absolute and differential channels, referred to as “conventional bobbin channels”, similar to what is obtained with an RFT probe. The absolute and differential signals from the bobbin coils will produce Strip charts, Lissajous and Voltage planes.

Next to these 2 coils is the array portion of the probe. It consists of 2 rows of sensors. The number of sensors per row depends on the diameter of the probe. The second row on the cable side is used to create the absolute array channels. The differential array channels are obtained by subtracting the signals of row 1 from row 2. As with conventional channels, the absolute array is used to analyze large volumetric defects, such as taper defects for example, and the differential array is used to analyze smaller defects such as pits. The channels of the array component of the probe are combined to produce C-Scan imaging.

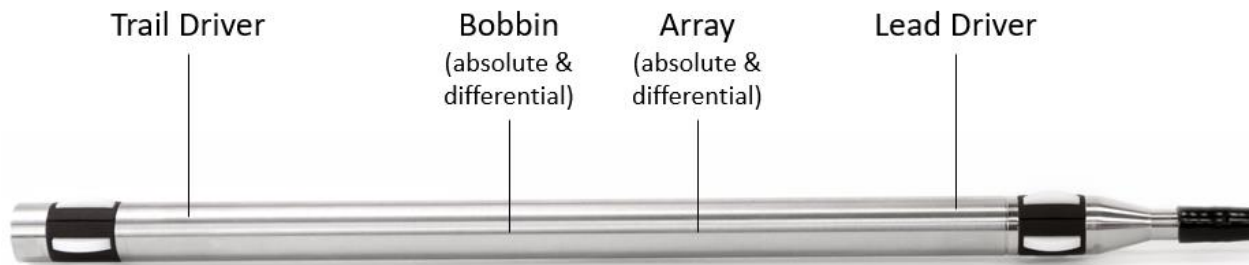

Note that neither the conventional coils nor the array part is perfectly centered between the 2 drivers.

## PROJECT AND INSPECTION FILES

---

In this section, we will create a folder structure that will manage the saving location of your setup, data, and report. This management is operated through the creation of a *Project*.

Magnifi suggests two levels of files. The first file level is the *Project*. It is meant to include different inspections that are related in some way. For instance, it can include all the inspections done at a refinery shutdown and be named *Refinery\_Shutdown\_May\_2022*. The second file level is the *Inspection* folder. Inspection folders are saved in the project file. An inspection folder can include the data specific to the inspection of a tube bundle with a specific technology and could be named *CS\_075x0.083\_RFA*, for instance. This inspection folder groups the setup, the tube list, the data files and the Magnifi report.

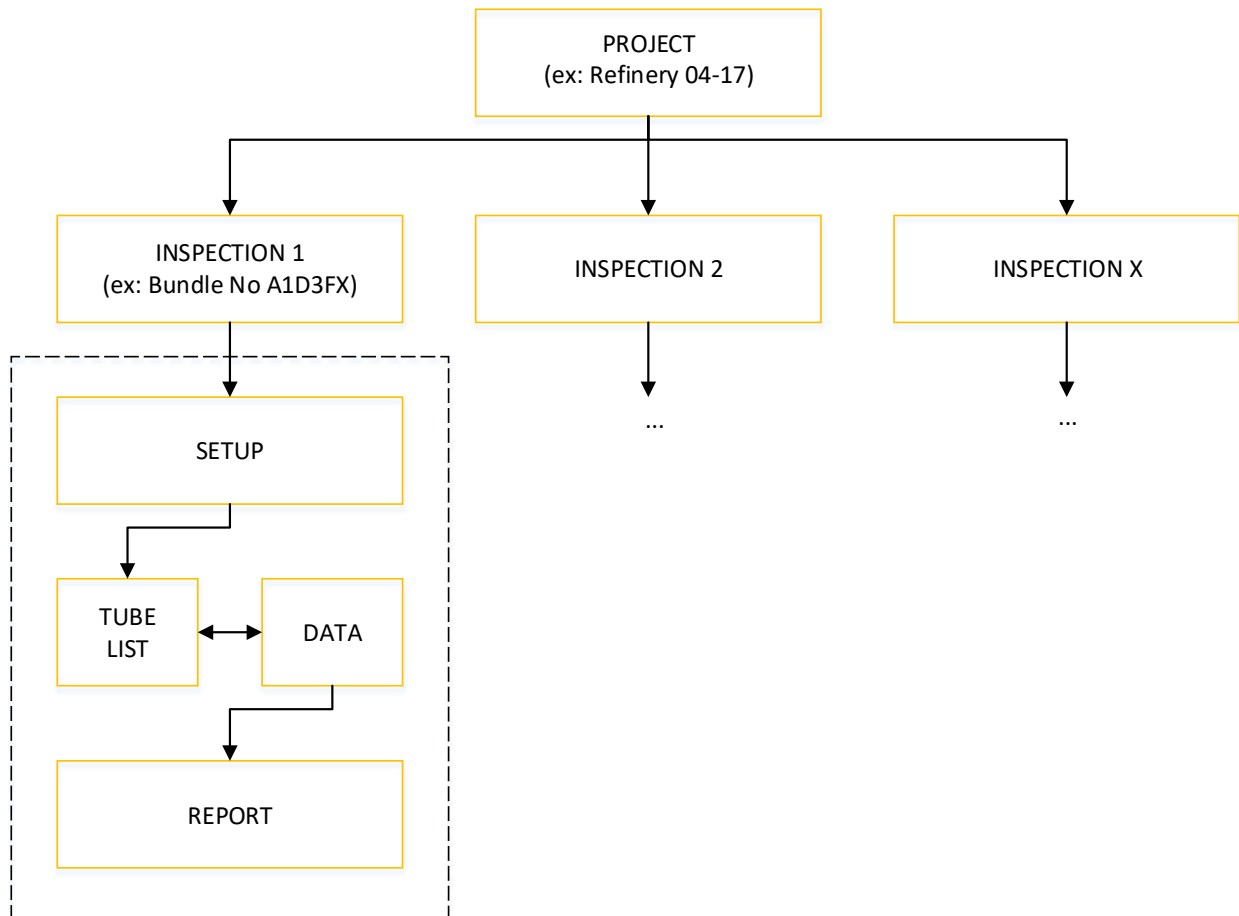

When you open Magnifi, the first page displayed is called the *Backstage*.

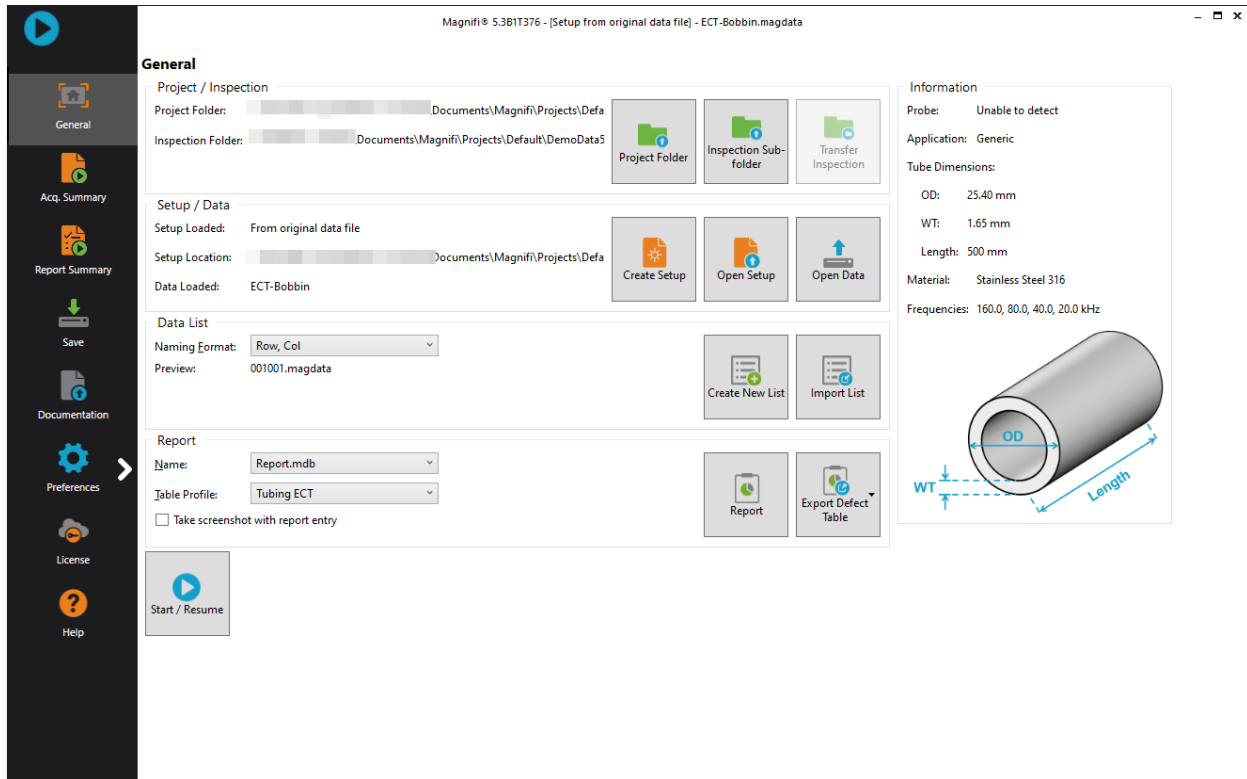

To create or open a project, click on *Open/Add Project* in the *Backstage*. You can select an existing project/folder, or you can create a new folder.

5. Create a folder by right-clicking on the location where you want to add your project file. Select *New, Folder* and enter the chosen name. You can then select the newly created folder and click on *Select Folder*.

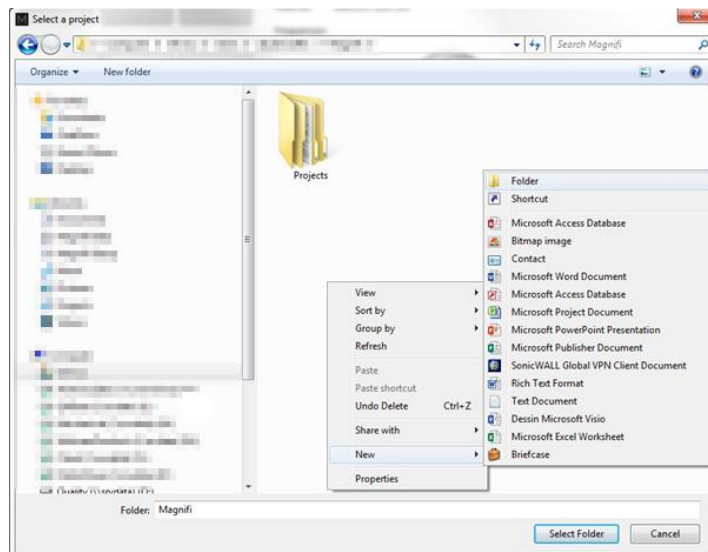

6. Click on *Add/Open Inspection* in the backstage, then click on *Add* and enter the name of your inspection.

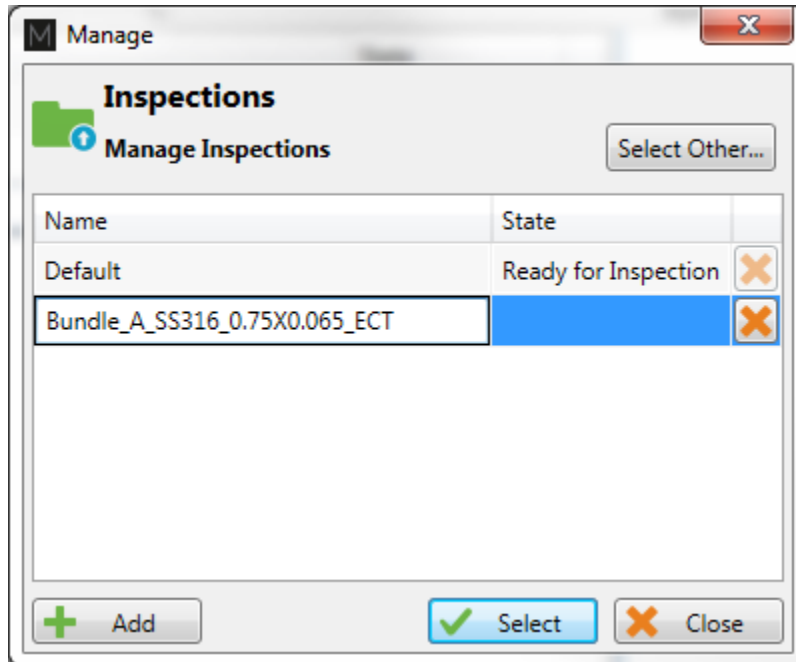

7. Click *Select*. This will define the location where the setup(s) and data will be saved.

## RFA SETUP WIZARD

---

In this section, we will show how to create a setup using the *RFA Setup Wizard* in Magnifi.

Before going further, you can select the appropriate measurement unit. To do so, click on *Preferences*. In the *System* tab, you can change the measurement units from metric to imperial and vice versa. For the metric units, you can choose to use meters, centimeters, or millimeters in the *General* tab. For imperial units, inches must be used. When finished, click on *Preferences* again to go back to the *General* window of the *Backstage* menu.

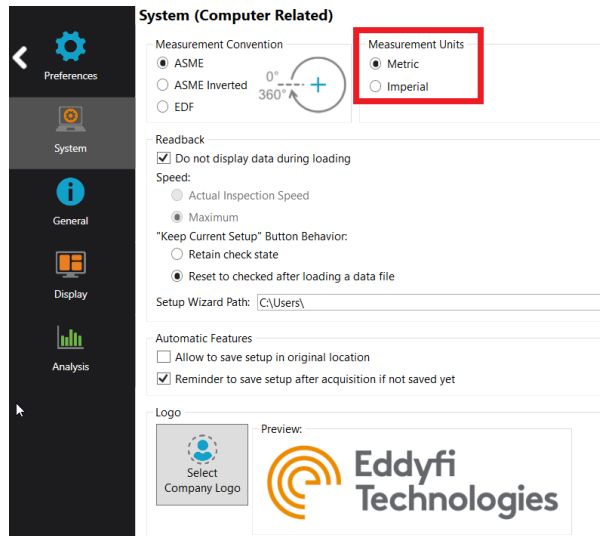

To create a new setup, use the RFA Setup Wizard process. Go to the *Frontstage* by clicking on the blue triangle at the top left corner of the *Backstage*. Then, click on the *New* button under the Setup tab and select the RFA Setup option in the drop-down menu.

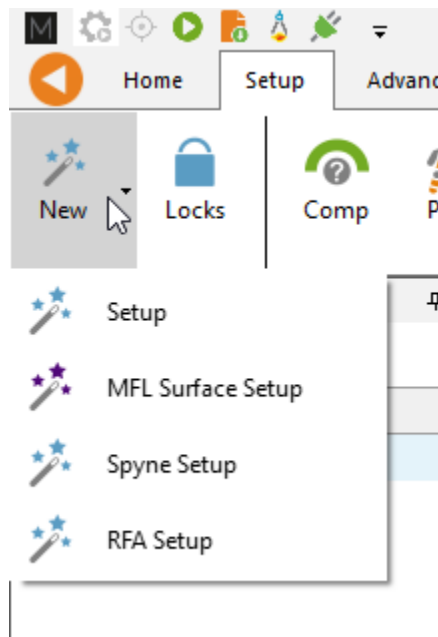

## PROBE SELECTION

The first page shown by the RFA Setup Wizard is the *Probe Selection* page.

In this window, the probe used for the inspection can be selected, the interaction between the bobbin and array channels can be set, and the display and settings for the absolute channel can be changed.



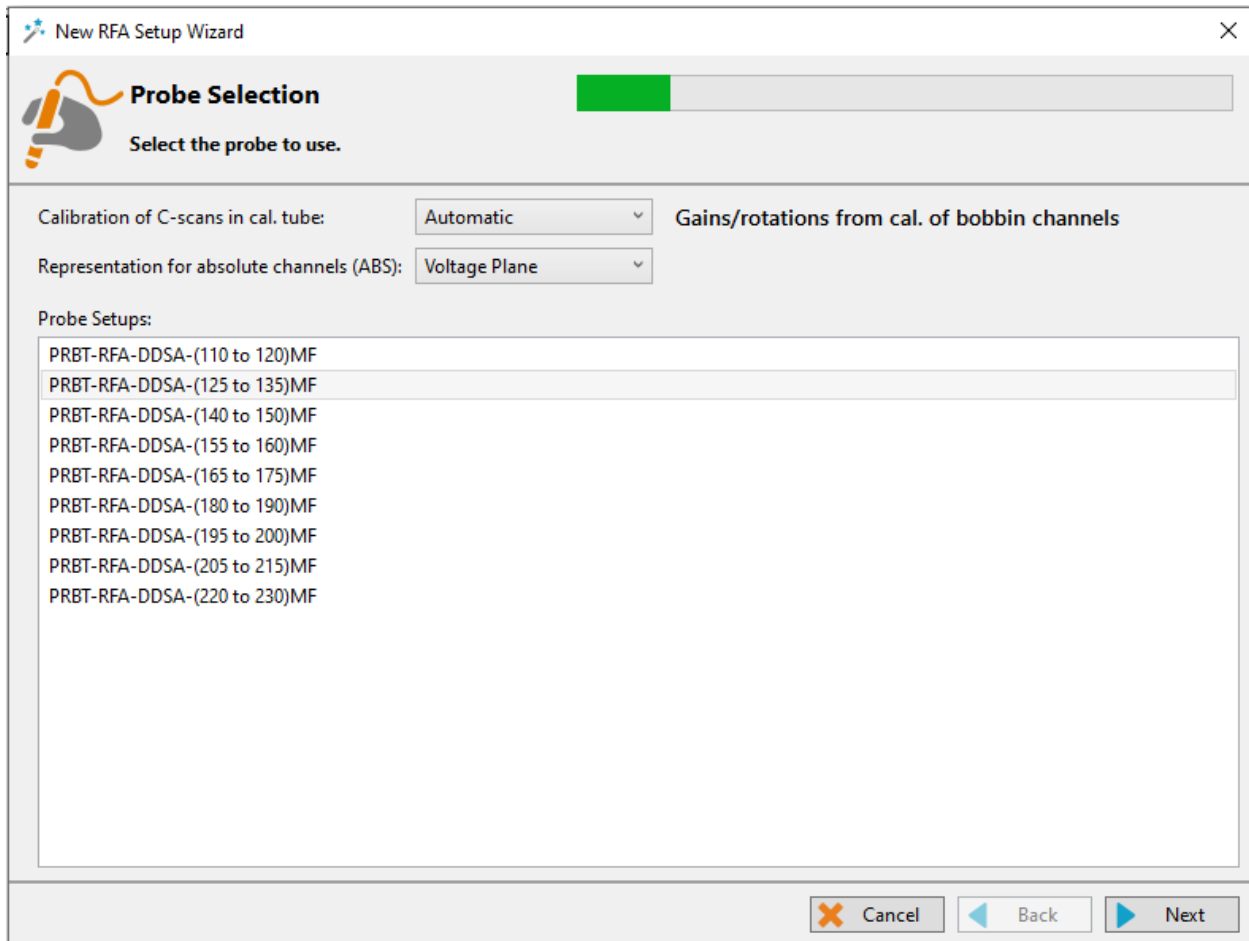

### CALIBRATION OF C-SCAN IN CAL. TUBE

In the software, the channels generated from the bobbin coils and the C-scans produced by the array are coupled, making the use of the RFA probe very similar to the RFT probe. Adjustments made to the conventional channels, such as the normalization of a support plate signal, are automatically propagated to the C-scans, allowing for easier analysis with a limited number of operations in the software.

The Calibration of C-scans option offers 2 possibilities:

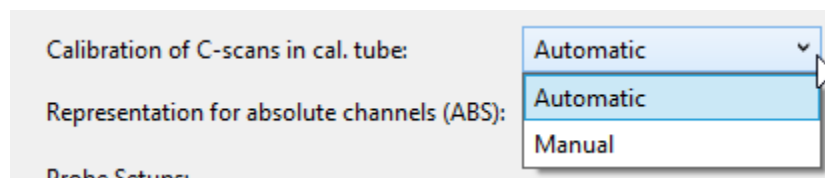

- Automatic: With this option, the probe is used the same way as an RFT probe would be used. The initial calibration of the conventional channels made in the calibration tube is automatically applied to the C-scans. Calibration of the C-scans independently from the channels is not possible.
- Manual: With this option, the C-scans must be calibrated independently from the conventional bobbin channels for the initial calibration in the calibration tube. It must be understood that once

the initial calibration has been performed, any subsequent change to the rotation or gain made to the conventional bobbin channels to adjust the nominal point, for instance, will be automatically applied to the C-scans as well. This is true for both options.

These options will be explained in more detail in the calibration section of this document.

### REPRESENTATION FOR ABSOLUTE CHANNELS (ABS)

The Representation for absolute channels (ABS) drop-down menu allows for the selection of either a standard Lissajous plot or a Voltage plane for the bobbin absolute channels. Note that this option does not affect the representation for the Absolute C-scans, which always use a Lissajous representation. The Voltage plane tool is explained in the appendix.

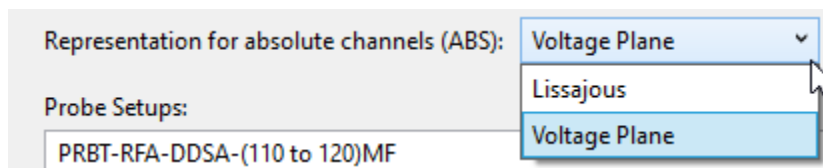

### PROBE SETUPS

In the *Probe Setups* section of the window, select the probe model used for inspection. The numbers inside the parentheses correspond to the range of probe's diameter covered with a specific setup. Refer to this information to find the appropriate model. For example, if an 18.0 mm mid-frequency probe is used, the PRBT-RFA-DDSA-(180 to 190)MF setup should be selected.

### COMPONENT DEFINITION

The second page shown by the Setup Wizard is the Component Definition page.

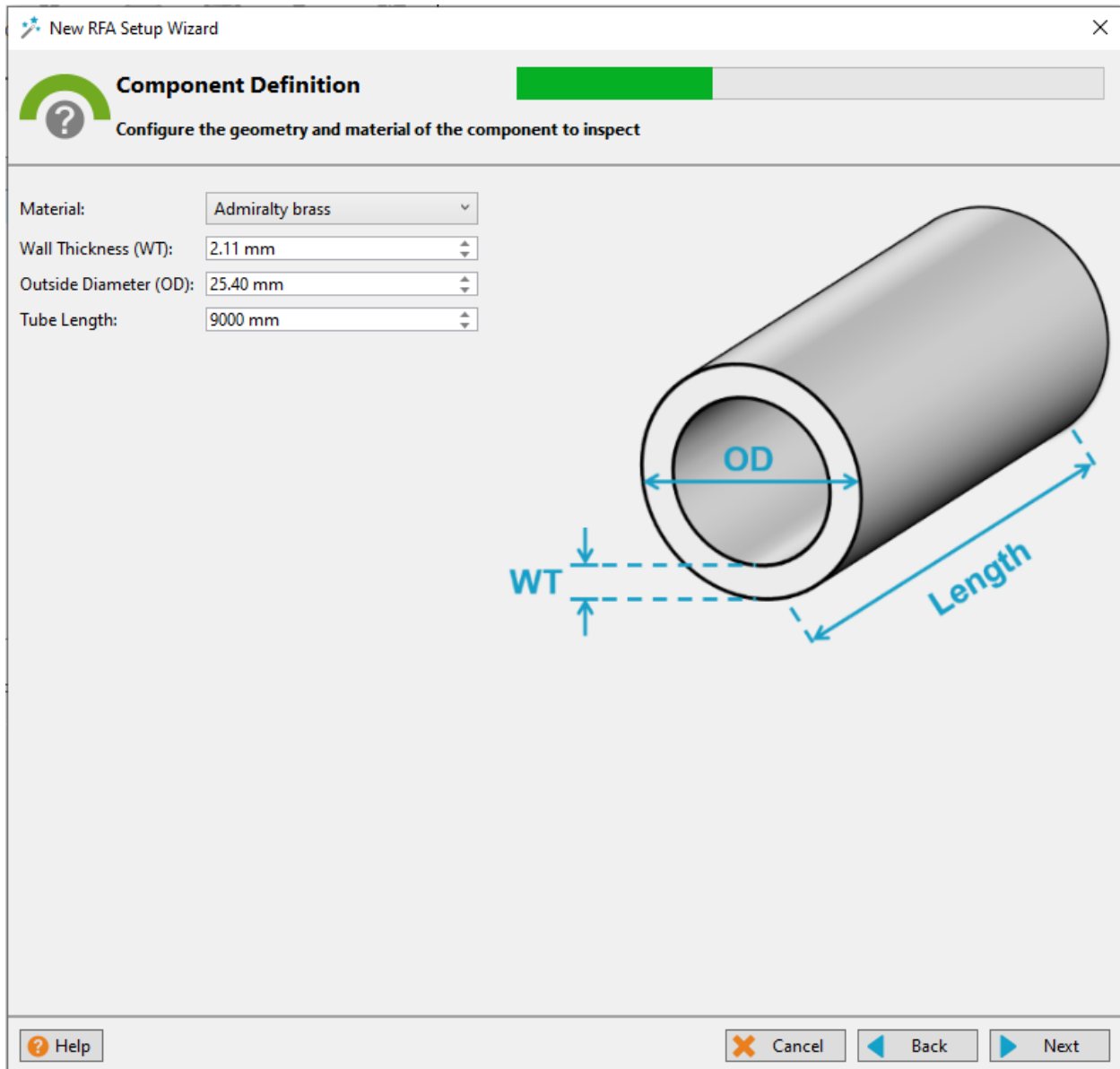

Click on the Material field to open the drop-down menu. Select the material of the tube to be inspected. If the inspected material is not on the list, go to *Backstage* and open the Material Database tab. To add a new material to the list, click on *Add*. A new line will appear in the list. Give the material a relevant name and set the material resistivity and permeability to its theoretical value. The ultrasound velocity is used to set IRIS parameters only, and doesn't need to be set if an IRIS inspection is not performed on this material. It is possible to add optional notes about the material to specify information such as its application or composition.

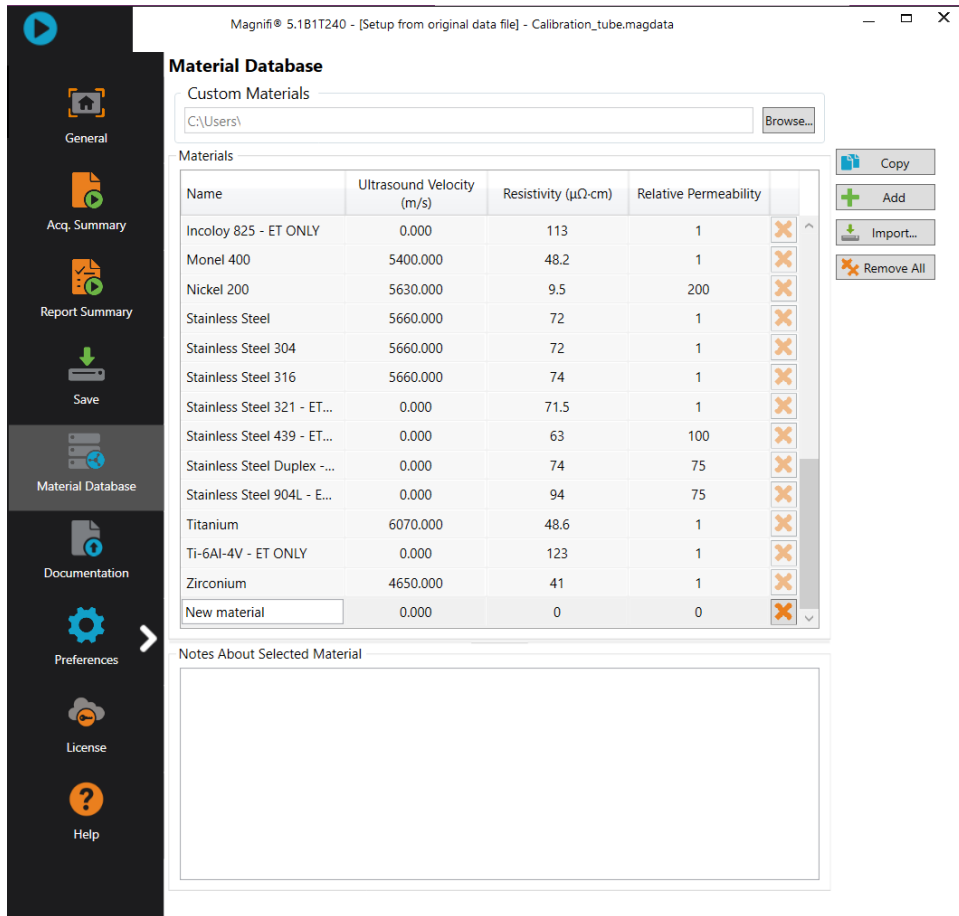

Also in the Component Definition page, adjust the tube wall thickness, outside diameter and length by entering the values in the designated fields. All the information filled in on this page will be used by the software when generating the analysis report.

The tube length defined here is also used as a default suggestion when enabling the automatic detection of landmarks.

Click *Next* when everything is set correctly.

## SCAN DEFINITION

The *Scan Definition* window is used to configure the data acquisition rate of the instrument, the typical probe pulling speed, and the acquisition size.

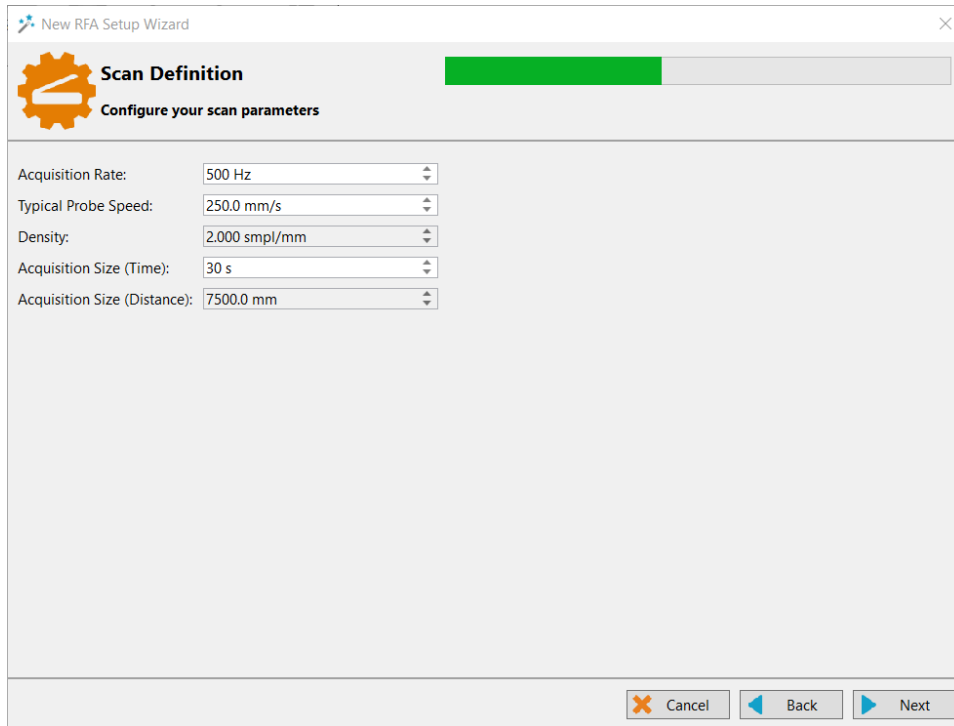

The acquisition rate corresponds to the number of acquisition points, or samples, taken per second. By default, the acquisition rate is set to 500 Hz for RFA, but depending on the drive frequency used to inspect, the actual acquisition rate may need to be changed.

The recommended probe pulling speed for RFA depends on the excitation frequency, as defined in the Data Definition page of the Wizard, and is shown in the table below:

Excitation Frequency (Hz)		Maximum pulling speed	
Minimum	Maximum	Imperial (in/s)	Metric (mm/s)
20	100	4	100
100	200	6	150
200	350	8	200
350	500	10	250
500	1000	12	300
1000	-	20	500

The density, or axial resolution, is the number of samples per unit of distance. This field is non-editable as it is a direct result of the acquisition rate and pulling speed combined. Use this information to confirm that both parameters are defined adequately.

A resolution of 2 points per millimeter is typically targeted. Given that the probe speed value is based on the excitation frequency, the acquisition rate can be edited to obtain the desired axial resolution.

For instance, if the pulling speed was set to 300 mm/s, then the acquisition rate should be set to 600 Hz to reach a resolution of 2 points per millimeter.

Note that if a probe pusher-puller mechanism is not used, the pulling speed will not be constant. Therefore, it is recommended to target a lower pulling speed to be able to reach the axial resolution target.

These parameters also serve another purpose. When analyzing a data file where landmarks are not enabled or defined yet, the axial position of the cursor in a strip chart is defined assuming a constant pulling speed. Therefore, if the cursor is located at exactly 4.0 seconds, and a probe speed of 300 mm/s was used, then Magnifi will indicate a position of 1200 mm. This information can be used to axially locate features and defects in the tube.

Report									
T (s)	$\Delta T$ (s)	$\odot X$ (smpl)	$\odot Y$ (smpl)	$\odot X$ (°)	$\Delta X$ (°)	$\odot Y$ (mm)	$\Delta Y$ (mm)	AR (Hz)	
4.256	1.806	8	2128	205.68	128.55	1064.0	451.5	500	

The last parameter that can be edited on this page is the Scan Size or scan duration, in units of time. The non-editable field below shows the same parameter in units of distance instead. The scan duration should be set to allow for acquisition of slightly longer than the tube length. This additional buffer time will ensure that the full tube length is captured even if there are some pulling speed variations and to provide enough time to insert the probe in the tube and completely pull it out in the air. For instance, if 30 seconds is needed to exactly capture the full 9 m length of tube, then a 40 second acquisition time could be set.

It is important to note that the acquisition size should not be set more than what is needed, as this could result in software memory issues.

Click *Next* when finished.

## DATA DEFINITION

The *Data Definition* window is used to set the hardware gain, excitation frequencies and drive voltages (or amplitude). It is important to set these parameters correctly before acquiring the data, since they are driven by the instrument and cannot be modified during the analysis.

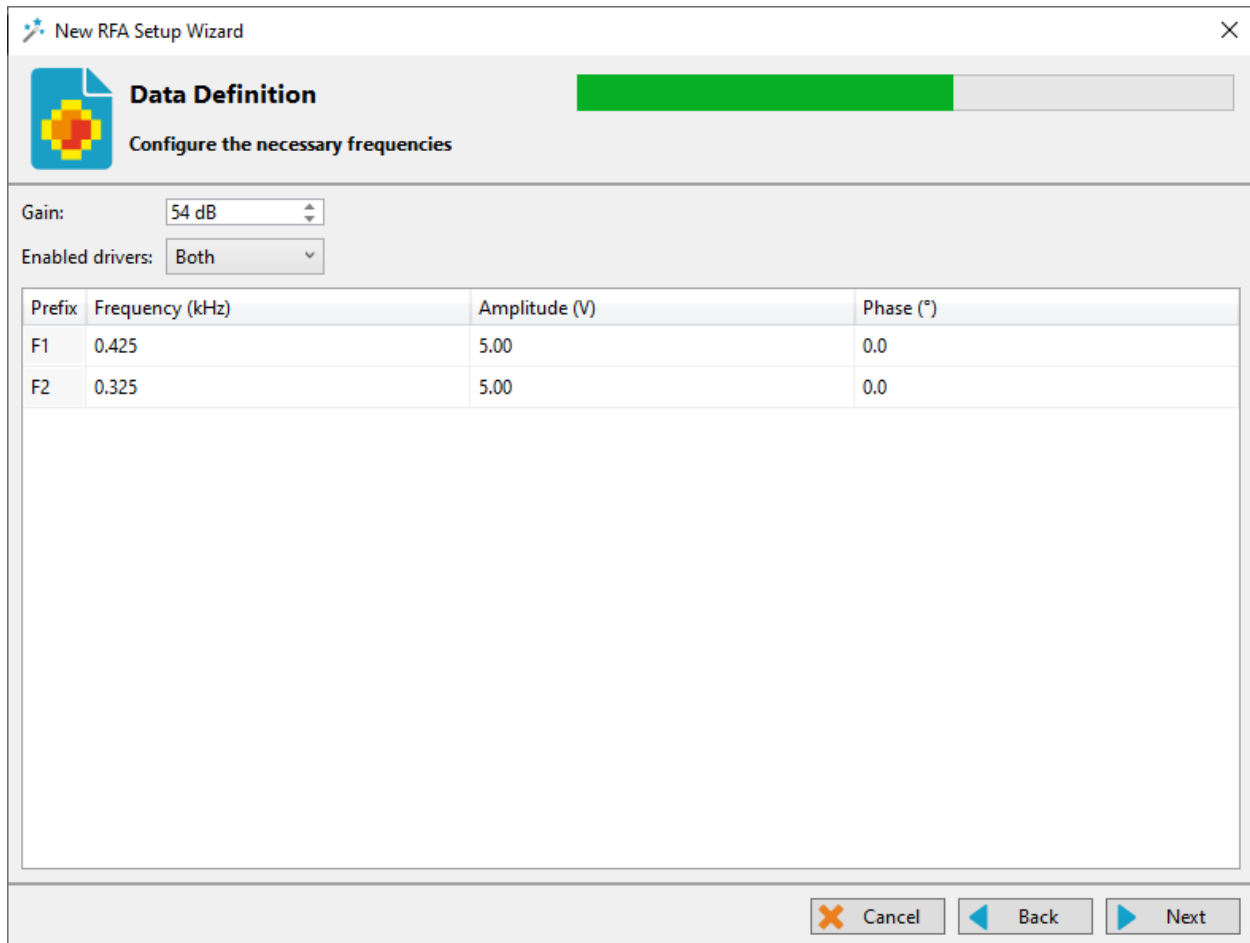

The hardware gain is applied to both the bobbin and the array portions of the probe.

Two frequencies are always enabled with RFA setups. The table in this window can be used to edit the frequencies and drive voltages values. The sum of their amplitudes cannot exceed 10 V.

Selecting an appropriate frequency can be aided with the following equation:

$$f = \frac{40.5 \cdot \rho}{\mu_r \cdot t^2},$$

where  $f$  is given in kHz,  $\rho$  is the tube's resistivity in  $\mu\Omega \cdot \text{cm}$ ,  $\mu_r$  is the relative permeability, and  $t$  is the thickness in millimeters. It is important to make sure the frequency selected is within the probe limits found in the table above. Another point of consideration when selecting the operating frequency is the frequency of the power transmission lines and outlets in your global region of inspection. It is recommended to avoid the harmonics of the outlet frequency to prevent noise issues. The figures below show the frequency ranges for 60 Hz and 50 Hz.

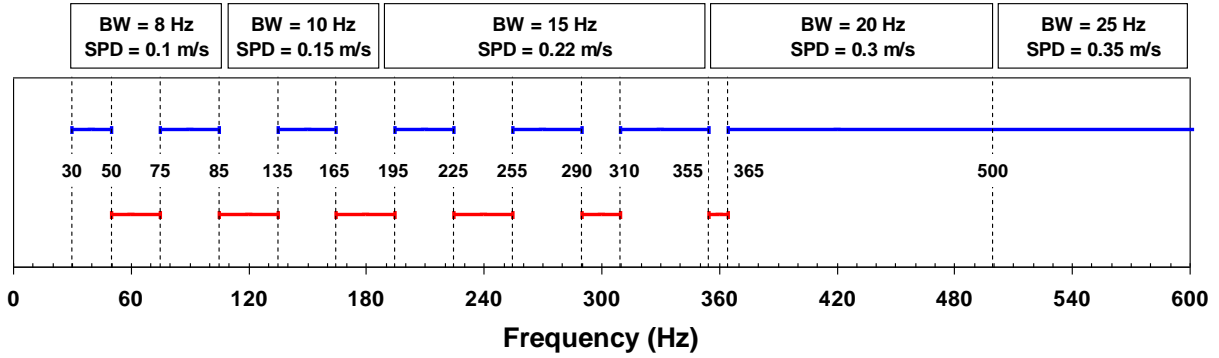

- Frequency range to avoid      - Frequency range allowed

Recommended frequencies for power outlet at 60 Hz

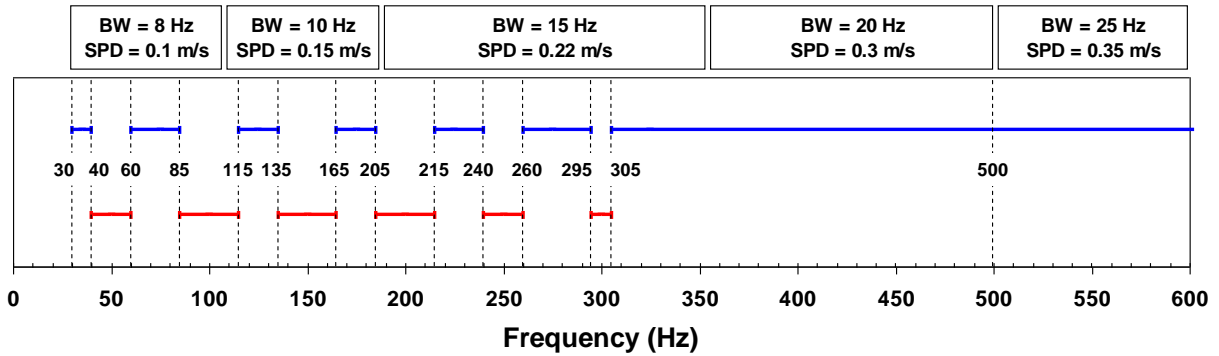

- Frequency range to avoid      - Frequency range allowed

Recommended frequencies for power outlet at 50 Hz

By default, the RFA probe operates as a dual-driver probe. However, it is possible to turn one driver off to use it as a single-driver probe. To do so, select the *Lead* or the *Trail* option in the *Enabled Drivers* drop-down menu. The *Lead* corresponds to the driver that is close to the cable; this is the first driver to reach a feature when the probe is pulled. The *Trail* is the driver closest to the tip of the probe.

If you choose to use the probe in single-driver mode, the Setup Wizard will automatically divide the drive voltage values in half for both frequencies, and the amplitudes will no longer be editable. A warning will also appear, indicating that these values were adjusted to generate approximately the same driver output.



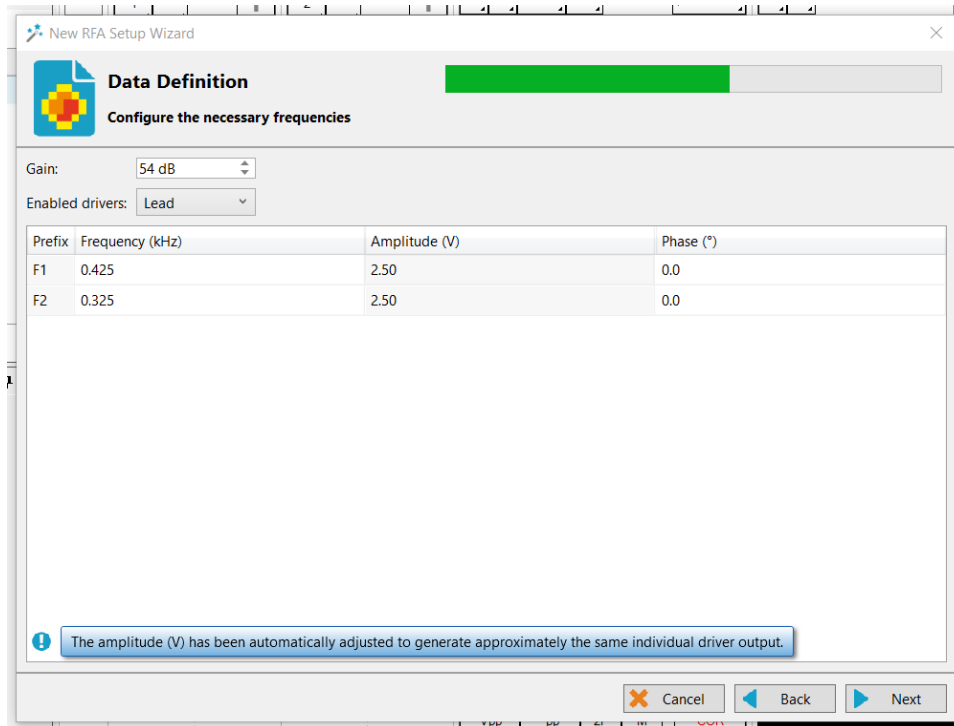

This is done such that the driver signal has approximately the same amplitude, regardless of whether dual-driver or single-driver mode is used. An example is given below, where the amplitudes of the driver signals have roughly the same amplitude (shown with the red dotted line) for both mode settings. Additionally, it can be noted that the amplitude of the receiver signal, when the defect passes right under the receiving coil, has decreased by half as expected.

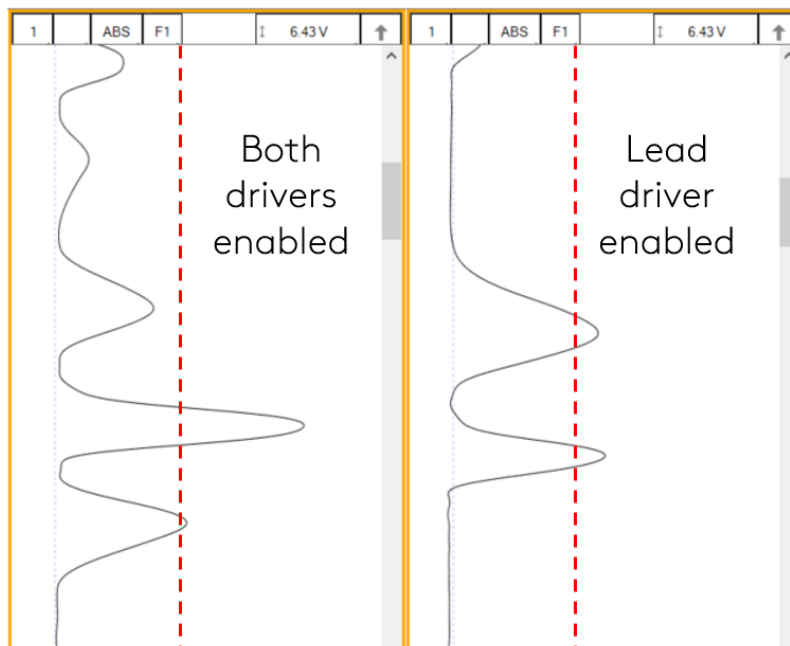

Should you need to change the drive voltage in single-driver mode, select the option Both, edit the voltage value and then select the option Lead or Trail again.

Click on *Next* when the desired parameters are entered.

## DATA PROCESSING

The *Data Processing* section is where post-processing software filters can be activated on the channels of the RFA probe.

The hardware parameters that were defined in the Data Definition page of the Wizard cannot be modified once the acquisition is completed. Therefore, it is crucial to validate those values before performing data acquisition. In the case of the Data Processing page, the available parameters allow you to enable and edit post-processing filters. Therefore, it is always possible to edit these parameters to fine tune the analysis after the data acquisition if needed.

The first page of the Data Processing section presents the list of available C-scans and their filters.

**Data Processing**  
Configure the processes to apply to the C-scans.

C-Scans

Name	Low Pass		Median High Pass		Periodic Noise	
	<input type="checkbox"/>	Cutoff (Hz)	<input type="checkbox"/>	Window Size (smpl)	<input type="checkbox"/>	Window Size (smpl)   Noise Threshold (V)
F1ABSA	<input checked="" type="checkbox"/>	20	<input checked="" type="checkbox"/>	401	<input type="checkbox"/>	35   0.030
F1ABSA-LargeSignal	<input checked="" type="checkbox"/>	20	<input type="checkbox"/>	401	<input type="checkbox"/>	35   0.030
F1DIFA	<input checked="" type="checkbox"/>	20	<input checked="" type="checkbox"/>	401	<input type="checkbox"/>	35   0.030
F2ABSA	<input checked="" type="checkbox"/>	20	<input checked="" type="checkbox"/>	401	<input type="checkbox"/>	35   0.030
F2ABSA-LargeSignal	<input checked="" type="checkbox"/>	20	<input type="checkbox"/>	401	<input type="checkbox"/>	35   0.030
F2DIFA	<input checked="" type="checkbox"/>	20	<input checked="" type="checkbox"/>	401	<input type="checkbox"/>	35   0.030

Before enabling the Periodic Noise filter, learn how to configure it adequately with the RFA probe user guide available in the Documentation section of Magnifi.

Cancel Back Next

The following table describes each of the C-scans:

Name	Description
F1ABSA-LargeSignal	Frequency 1, Absolute Array, Large Signal. Dedicated C-scan that should be configured (filters values and color palette range) to optimize the analysis of large indications such as taper defects
F1ABSA	Frequency 1, Absolute Array, Trail row of sensors (farthest from the cable)
F1DIFA	Frequency 1, Differential Array
F2ABSA-LargeSignal	Frequency 2, Absolute Array, Large Signal. Dedicated C-scan that should be configured (filters values and color palette range) to optimize the analysis of large indications such as taper defects
F2ABSA	Frequency 1, Absolute Array, Trail row of sensors (farthest from the cable)
F2DIFA	Frequency 2, Differential Array

Three types of filters are available. The low-pass filter eliminates part of the signal that is above a certain frequency. As an example, it is useful when a defect signal has a lower frequency content than the background noise. In this case, using a filter will remove part of the noise without removing the defect's signal. This may help with data analysis. However, a cut-off frequency that is too high won't remove much noise, and a cut-off frequency that is too low will filter out the defect signals.

The median high-pass filter is used to filter out low frequency noise or drift such as lift-off variations of the probe within the tube, or changes in material, geometry, or thickness. As a rule-of-thumb, the window size of the high-pass median filter should be set to at least three times the axial length of the longest flaw that may be encountered. This rule-of-thumb is specific to what you are looking for with the channel you are using. If, for example, you plan to use the differential channel to detect holes, you can adjust this setting to about three times the length of the largest hole you are looking for with this channel. The window size should be adjusted with care. If it is set too small, it could filter out defects of interest. Note that the size of the filter is set in samples and not in mm. For example, if you have set your parameters to have 2 samples/mm and you want to enter a length of 300mm, then you should use a value of 600 samples.

Pilger noise<sup>1</sup> is yet another type of noise that can be observed on tubing data that can negatively alter the amplitude and phase of the signal. The Periodic filter can be enabled to reduce the effects of this phenomenon. Similar to the other filters, there is always a trade-off between the noise reduction level and the side-effects of the filter on the indication signals themselves when adjusting the parameters of the filter. It is not recommended to apply this filter by default, but it can be used on tube data that contains a strong pilgering signal.

---

<sup>1</sup> Pilger noise is caused by the cold pilgering process in which the diameter and wall-thickness of a tube are reduced to form seamless metal tubing. Pilger noise is typically seen as spiral-shaped variations on a C-scan. Because of the helical shape of pilger noise in the tube, the noise is somewhat periodical, but not constant.

More details about the adequate configuration of this filter can be found in Appendix 2.

The second page of the *Data Processing* section presents the list of available bobbin channels and their filters.

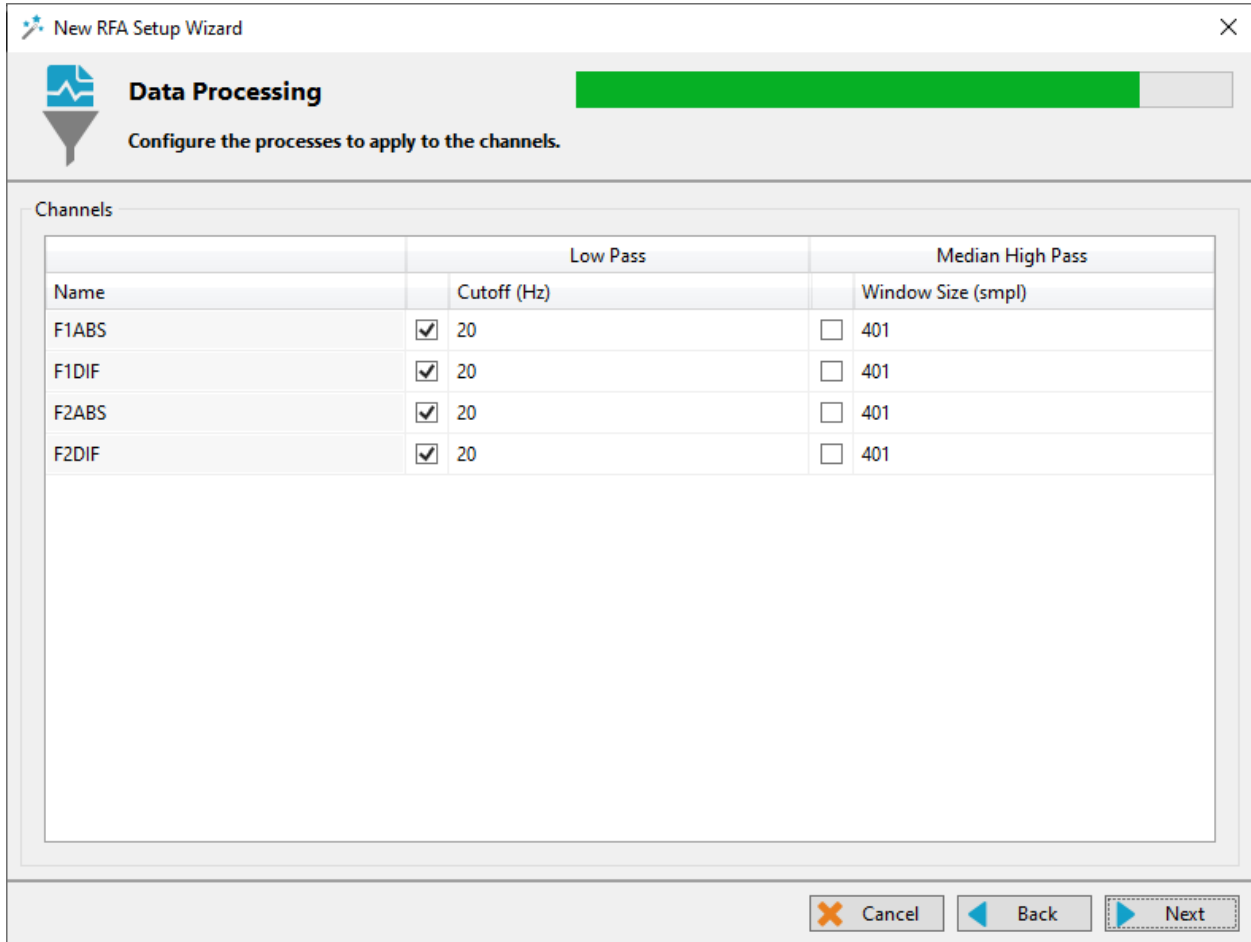

The following table describes each of the channels:

Name	Description
F1ABS	Frequency 1, Absolute Bobbin
F1DIF	Frequency 1, Differential Bobbin
F2ABS	Frequency 2, Absolute Bobbin
F2DIF	Frequency 2, Differential Bobbin

Low-Pass and Median High-Pass filters are available for these channels. The comments made for the C-scan filters above can also be applied with the channel filter.

Data should be examined in its filtered and unfiltered states. It is important to keep in mind that the filters can distort the phase and change the amplitude of the signals.

Click *Next* when finished.

## INDICATION CODES

The Indication Codes page is used to define the entries that can be added to the report when analyzing the data.

Code	Description	Type	Automatic	Color	
COR	Corrosion	Defect			X
CRK	Crack	Defect			X
DNT	Dent	Defect			X
DSI	Distorted Support Indicati	Defect			X
ERO	Erosion	Defect			X
NDD	No Defect Detected	No indication			X
OBS	Obstructed	Feature		Red	X
PIT	Pitting	Defect			X
PLG	Plugged	Feature		Brown	X
RST	Restricted	Feature		Yellow	X
WLL	Wall Loss Long	Defect			X
WLS	Wall Loss Short	Defect			X
WLT	Wall Loss Taper	Defect			X

When an indication is added, its abbreviation (code) is shown in the code pane, next to the data.

You can modify the default indication code list by changing the parameter in the table. New indications can be defined by clicking on the *Add* button.

Click *Finish* to complete the RFA setup wizard process.

## SETUP MODIFICATIONS

---

Some parameters or preferences may need to be modified after completing the Setup Wizard process. To modify a parameter previously entered, go to the Setup tab in the Frontstage and click on the button associated with the parameter you want to change.

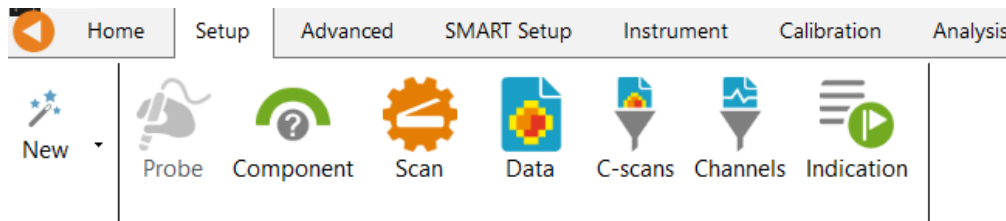

This will open one of the windows previously described, where you can change the values you originally entered. If applicable, go through the process by clicking on *Next*, and then click on the *Finish* button. This will apply the modification to the setup.

It is important to note that the parameters defined in the Probe Selection window cannot be changed after the initial generation of the setup. If you wish to change the probe model, the Calibration of C-scans option, or the representation for the Absolute channels, you must create a completely new setup.

Advanced setup modifications are also possible in the Advanced Setup section on page 315.

## DATA LIST

---

Magnifi will save a file for each inspected tube. The file names are defined by creating the list of tubes.

This list can be created in the *Data List* section of the *General* tab of the *Backstage*.

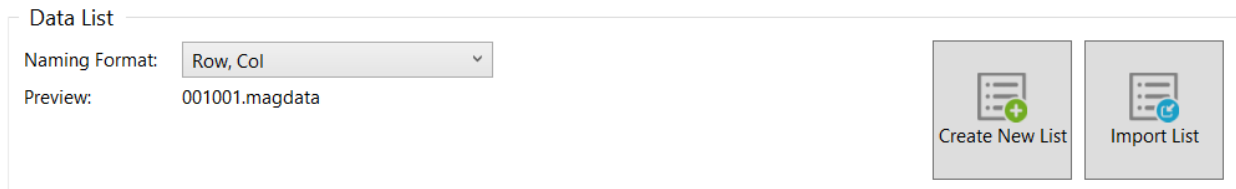

Four options are available to set the filename format:

- 1. Free format:**  
Each file has a custom name. Can also be defined from the Data tab of the Front Stage.
- 2. Prefix:**  
The file name includes a defined prefix followed by a sequential number.
- 3. Row, Col:**

Row number, Column number. Mostly used for tubing inspections.

**4. Zone, Row, Col:**

Zone number, Row number, Column number. Mostly used for tubing inspections.

Click on the *Create New List* button. The displayed window will be different depending on the chosen filename format.

For the *Row, Col* option, enter the number of rows, the starting row number and row interval. You can then enter the number of tubes per row in the *Nb. of Columns* fields of the table. Click on *Create* to generate the list of tubes. You can also use the *Create & New* button to add another set of tubes to your list.

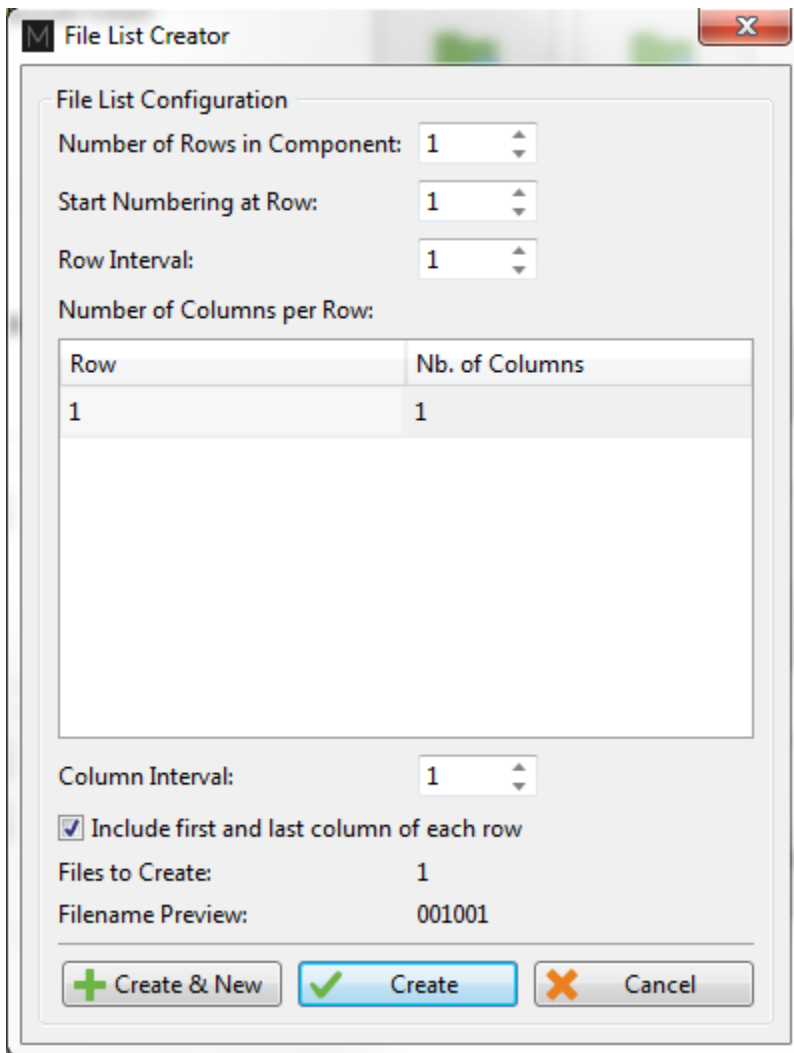

The same principles apply to the other file formats, except for the *Free format* option for which the file name(s) needs to be entered manually in the *Data* window of the *Frontstage*.

The tube list can also be imported from another project using the *Import List* button. The tube list file can be found in the Inspection folder. It is also possible to import a list created in the *TubePro* software (available from Eddyfi).

## PERFORMING AN ACQUISITION

1. If you are in the Backstage, move to the Frontstage by clicking on the Start/Resume button.
2. Click on the Connect button under the Instrument tab. This will open the Instrument Connection window. Click on the line showing the instrument to which you want to connect and then click Connect.

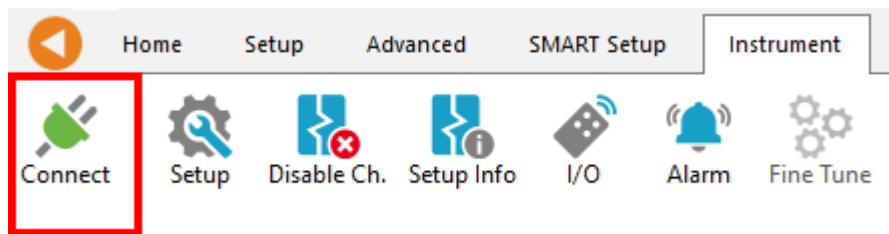

Note: Your Ectane firmware version may not match the version of Magnifi you are using. If this is the case, a red and white X icon will be shown in the Status field of the Instrument connection window. To send a matching version to your Ectane, click on the *Config.* button and then click the *Send firmware to the instrument* button of the *Instrument configuration* window.

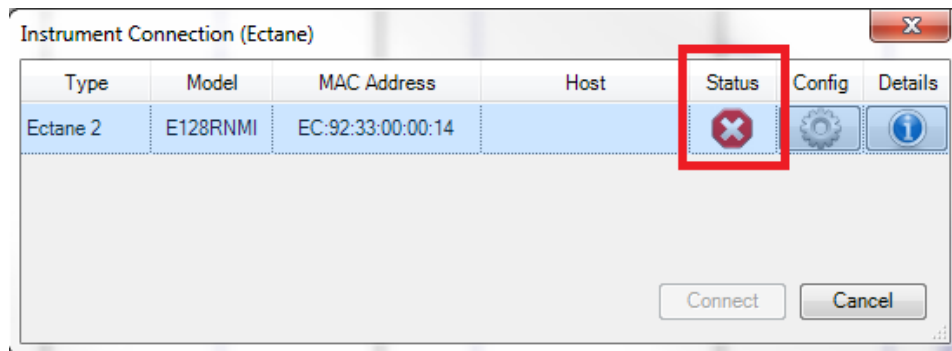



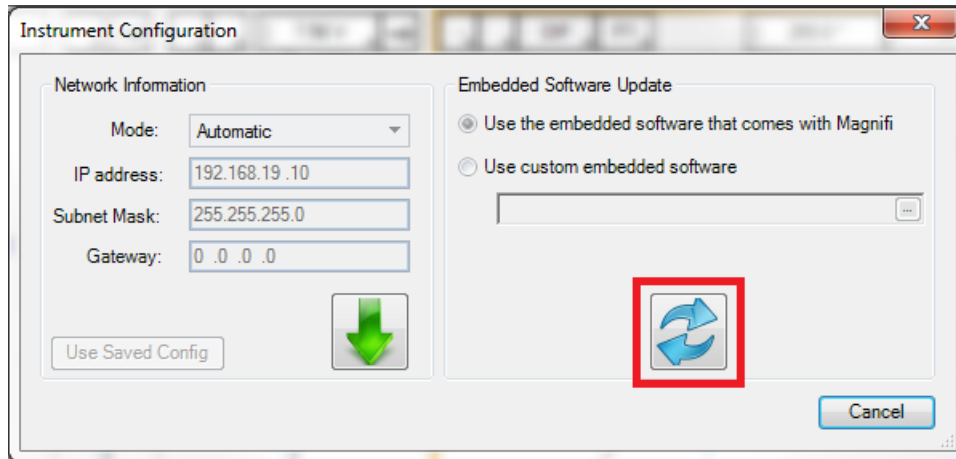

Two (2) acquisition modes are available in Magnifi: Setup Mode and Acquisition Mode. Setup Mode is used to scan your calibration tube and make the necessary adjustments on your setup without saving the data automatically. Acquisition Mode is used for the inspection. In this mode, the software automatically saves the acquired data using file names based on the tube list.

Follow the steps below to perform the acquisition of the calibration standard:

1. Enable Setup Mode by toggling on the Setup Mode button under the *Home* tab. This mode is active when the button is grayed.

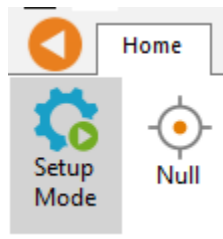

2. Plug the RFA probe into the Ectane 41-pin connector.
3. Bring the probe head in a clear area in your standard and balance the probe by clicking on the *Null* button under the *Home* tab, or press F6 on your keyboard.
4. Push the probe head all the way through the tube so that it exits the tube.
5. Start the acquisition by clicking on the *Acquire* button under the *Home* tab, or by pressing F2 on your keyboard.
6. Pull the probe at the recommended speed.
7. When the probe exits the tube, press the Stop button, or again F2 on your keyboard.

The image below shows a typical RFA scan of a calibration tube. No calibration has been performed yet.

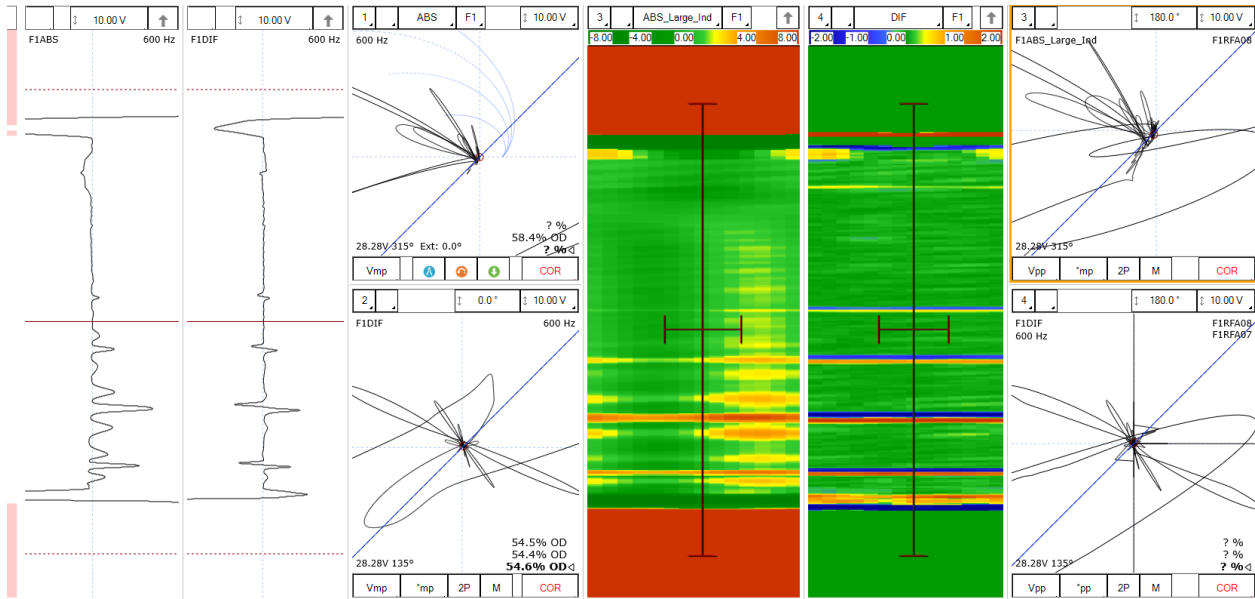

Note that a red zone in the code pane means that the raw signal from at least one of the channels is saturated. This is usually the case when your probe is not inside the tube.

## VISUALIZING THE DATA

### LAYOUT

By default, the setup generated with the RFA Wizard offers a layout that includes the following elements:

- 2 strip charts and Lissajous/Voltage plane corresponding to the bobbin (ABS, DIF) coils, similar to the conventional RFT setups generated with the Generic Wizard

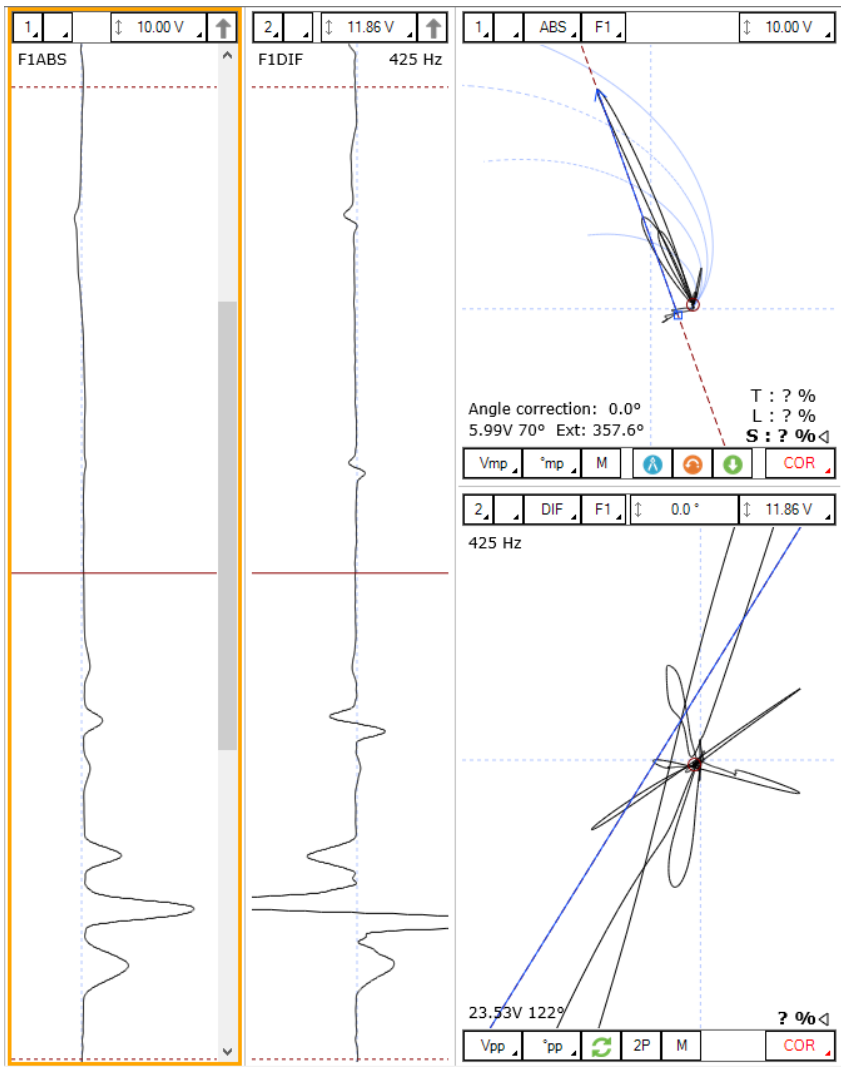

- 2 C-scans and 2 Lissajous corresponding to the array coils

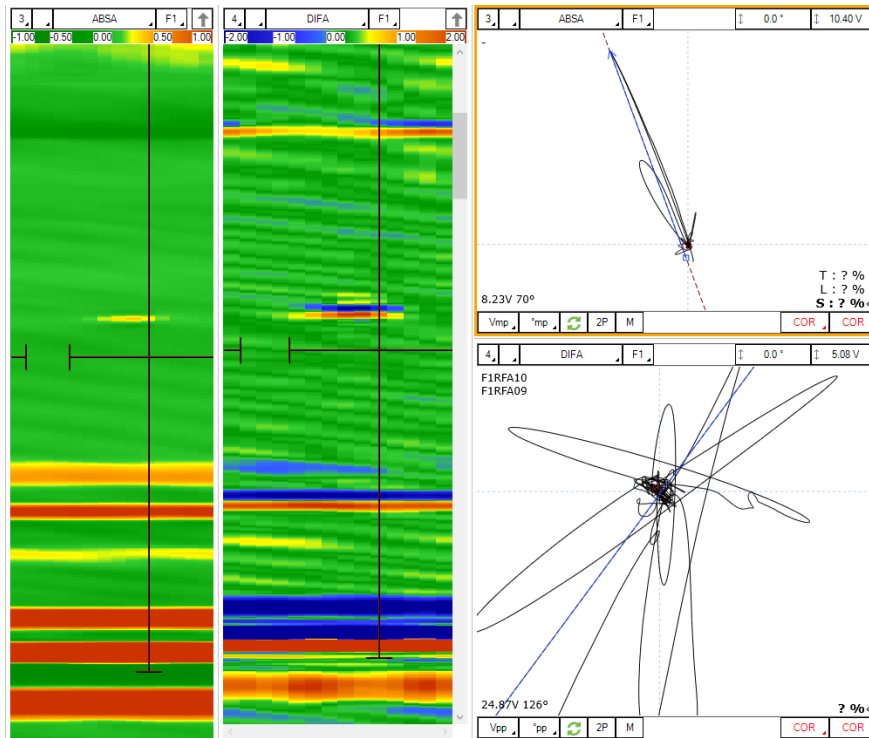

The tools found in the Layout ribbon can also be used to adjust the display settings to suit your preferences. Use the Replace, Remove or Split button to adjust the current display setting.

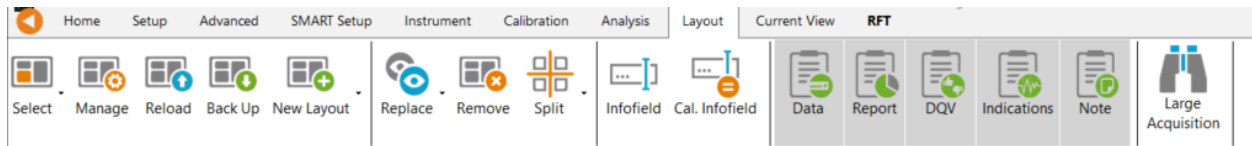

## DISPLAYED CHANNEL

There are four buttons at the upper left corner of the Strip charts and Lissajous windows. These buttons are used to adjust the display settings for a channel in the specified window.

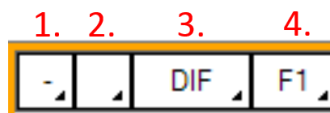

1. Links Strip charts and Lissajous to the same channel. For instance, if a Lissajous and a Strip chart are both set to 1, setting the Lissajous to DIF-F1 will also set the associated Strip chart to this channel.

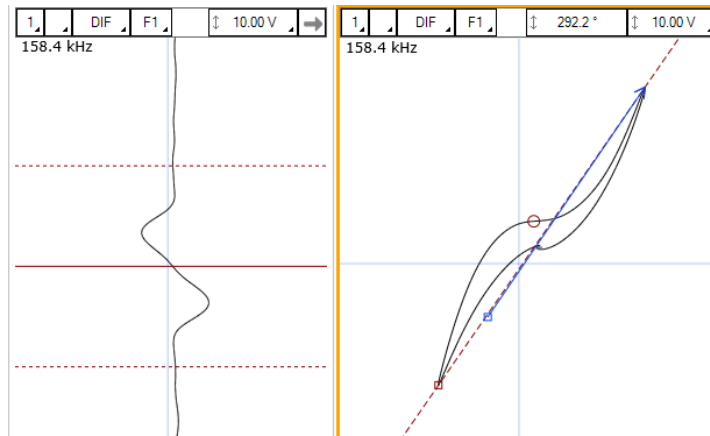

2. Clicking on the corner with the black triangle gives the list of available channels. Click on the desired channel to select it. Right-click or Left-click on this button to switch to the following or previous channel in the list.

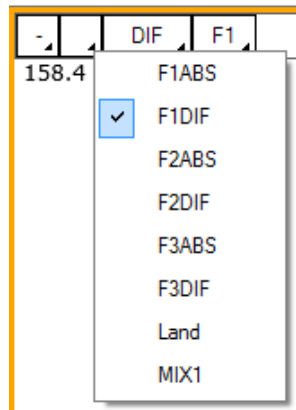

3. Same principle as 2., but for the type of channel only (absolute or differential).
4. Same principle as 2., but for the frequencies only.

## STRIP CHARTS AXIS ORIENTATION

The Strip charts are projections of the Lissajous on the vertical and horizontal axis. To switch from one axis to another, click on the box showing an arrow at the upper right corner of the Strip chart.



## ZOOMING

### BOBBIN CHANNELS

On the strip chart, hold the right button of your mouse and drag on the zone of interest to zoom in this section.

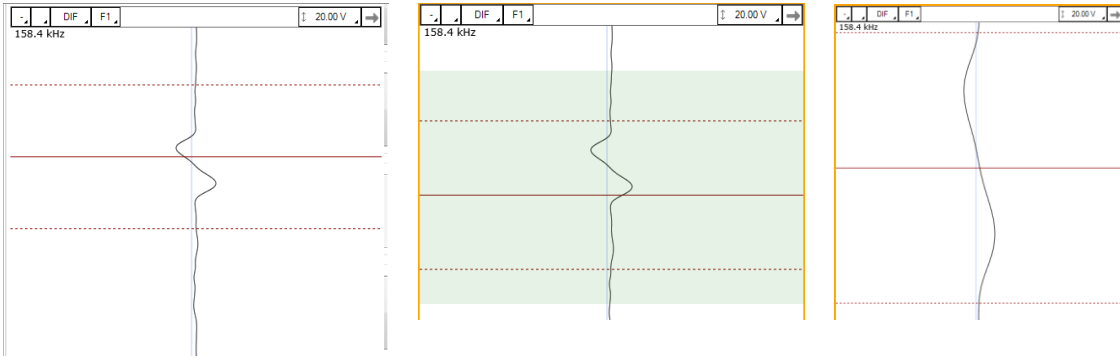

To zoom out, right-click on the Strip chart and select *Previous Zoom* or *Full Extent*.

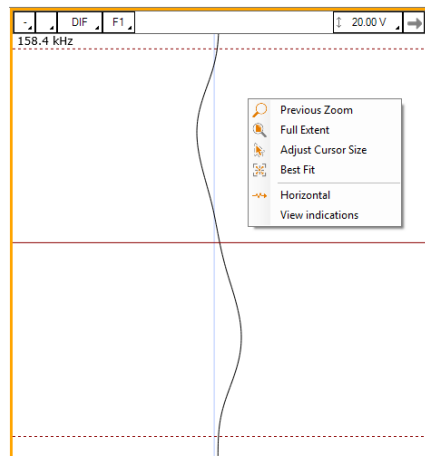

## ARRAY CHANNELS

On the C-scan, hold the right button of your mouse and drag on the zone of interest to zoom in on that section. You can drag your mouse either horizontally or vertically on the C-scan.

To zoom out, right-click on the C-scan and select *Zoom to Previous*, *Zoom to Content* or *Full Extent*.



## ADJUSTING THE CURSOR LENGTH

On the Strip chart, the cursor is composed of 3 lines. The dotted lines represent the limit of your cursor, and the solid line is the center of the selection.

Only the section bound by the dotted lines will be shown in the Lissajous.

Adjusting the cursor length is easily done using the mouse. Clicking and dragging on a dotted line with the left mouse button will adjust the 2 dotted lines symmetrically. To adjust only one dotted line, do the same operation with the right mouse button.

## ADJUSTING THE SCALE

The scale of a window (Lissajous or Strip chart) can be modified by clicking on the scale button with the left button (decrease scale) or the right button (increase scale) of your mouse.

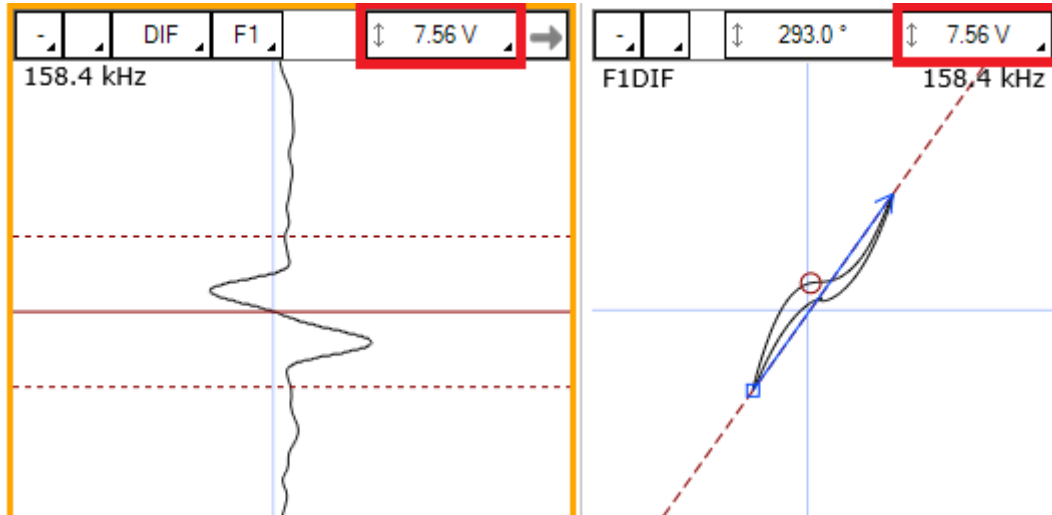

Another way to modify the scale is to click and drag (up or down) the right button of your mouse on the scale button.

## MEASUREMENT METHOD

The buttons at the lower left corner of the Lissajous windows are used to select the measurement method.



1. Clicking on the corner with the black triangle gives a list of measurement methods for the amplitude of the signal. Click on the desired method to select it. Right- or Left-click on this button to select the next or the previous method in the list.
2. Same as 1., but for the phase measurement.
3. Rotate the measured phase by 180°. This option can be used if the software doesn't measure the phase with the correct orientation.
4. Take the same two points in time to take the measurement in the other Lissajous.
5. Allow a manual measurement of the signal. Click and drag the left button of your mouse to draw a vector on your Lissajous.

## LISSAJOUS ROTATION AND PANNING

The signal in a Lissajous can be rotated by holding CTRL on the keyboard while holding the left button of your mouse and dragging it around the rotation axis. Note that this operation cannot be performed on the raw channels since these channels have no gain or rotation applied, by definition. Rotating the signal will affect your calibration, so if you perform this operation, make sure to recalibrate afterwards.



The origin point can also be moved by holding the left button of your mouse on the Lissajous background and by dragging it in the desired direction.

## DATA CENTERING

To center the data in the different windows, put your cursor at a point where you want the data to be centered and press on the space bar on the keyboard.

## C-SCAN DISPLAY ADJUSTMENT

Manual adjustments can be made to the C-scans to improve their display for the detection of defects.

One way of changing the display of a C-scan is by changing the color palette type and/or adjusting the scale of the color palette. To do so, double-click on the color palette ribbon at the top of the C-scan.

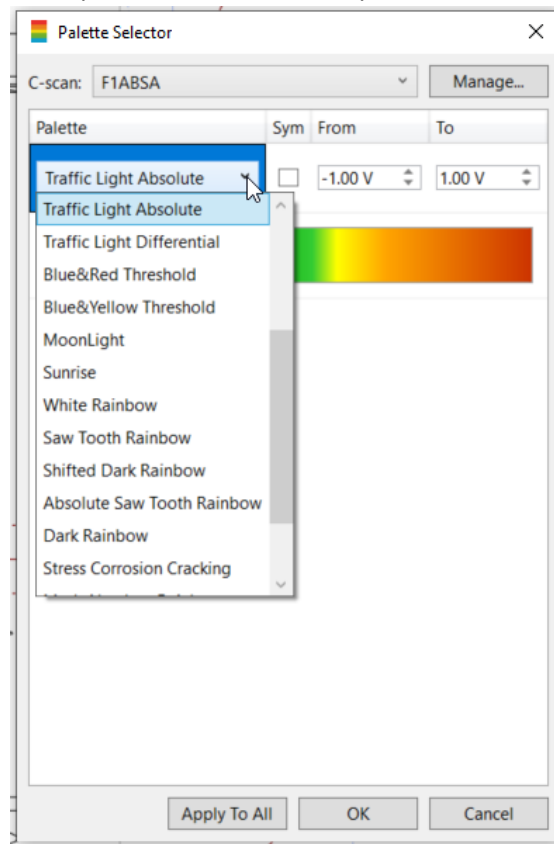
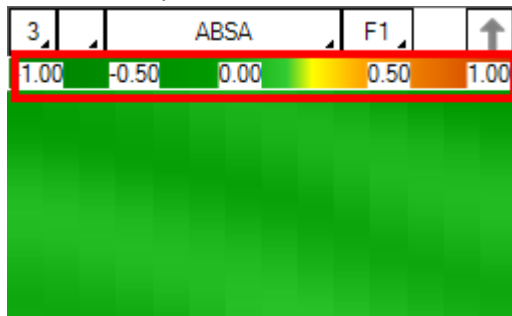

Another way of adjusting the display of the C-scan is to manually rotate the signal in the associated Lissajous. Below shows a C-scan with a pit signal circled in red. As shown by the arrow in the upper right corner of the C-scan pane, the C-scan shows the vertical components of the Lissajous.

On the Lissajous (below, left), the noise signal sits at approximately 60°. Manually rotating the Lissajous can be done by clicking and dragging the left-mouse button on the field highlighted in red. To minimize the noise signal, the Lissajous can be rotated such that the noise is horizontal.

After rotation (below, right), the pit signal becomes more prominent on the C-scan and the noise in the nominal sections of the tube (green) has been reduced.

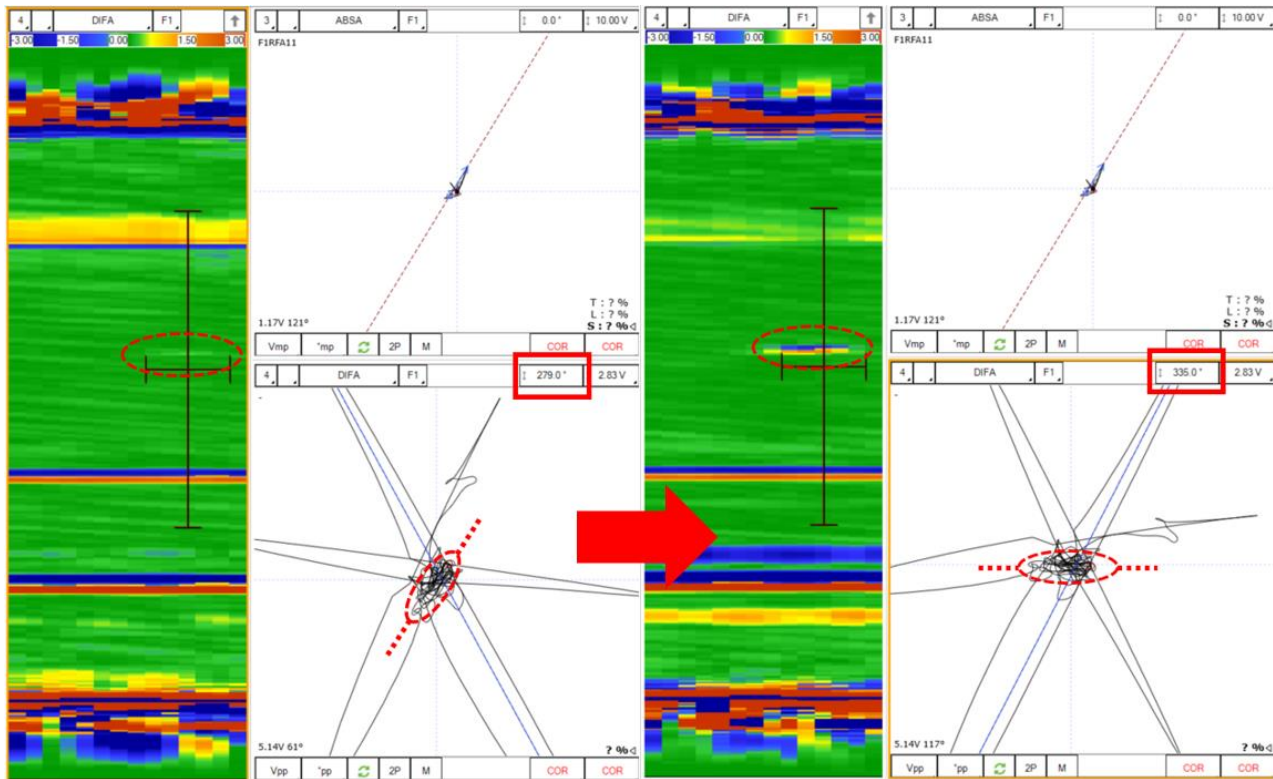

**Caution:** If you use sizing curves with the array part of the probe, it is necessary to readjust the manual rotation to zero so that the sizing curves give the expected values.

## SETUP ADJUSTMENT

### FREQUENCY VALIDATION

The injection frequency (set in the *Data definition* section) will influence the phase angle separation between flaws of different depths. It can also affect the signal-to-noise ratio of certain flaws.

If this frequency is too low, the phase angles of your flaws will be close to each other. Therefore, it will be difficult to build accurate sizing curves because a small variation of the phase will lead to a significant change of depth estimate.

Multiple methods can be used to validate that the injection frequency was correctly set. Here's two of them:

- There is approximately 1° of phase change per 1% of wall loss between two grooves of different depths. The two grooves must not be too close in terms of depth.

- There is approximately 65° of phase separation between a through-wall hole and a 4 x FBH 20% depth.

To adjust the injection frequency:

8. Click on the *Data* button under the *Setup* tab.

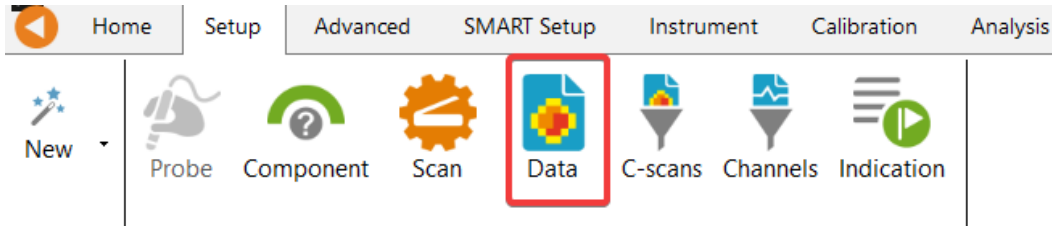

9. To increase the phase angle spread between your flaws, increase the injection frequency. Decrease the injection frequency to lower the phase angle spread.
10. Click on *Next* and then click on *Finish*.
11. Rescan your calibration tube.
12. Verify that your injection frequency is correct.
13. Redo steps 1 to 5 until you have an acceptable frequency.

### NOMINAL POINT VARIATION TOLERANCE

When renormalizing the support plane signal in the Voltage plane, the angle correction applied relative to the nominal point is displayed in the bottom left corner of the view. Magnifi offers the possibility to display this correction value in red if it exceeds an acceptable value.

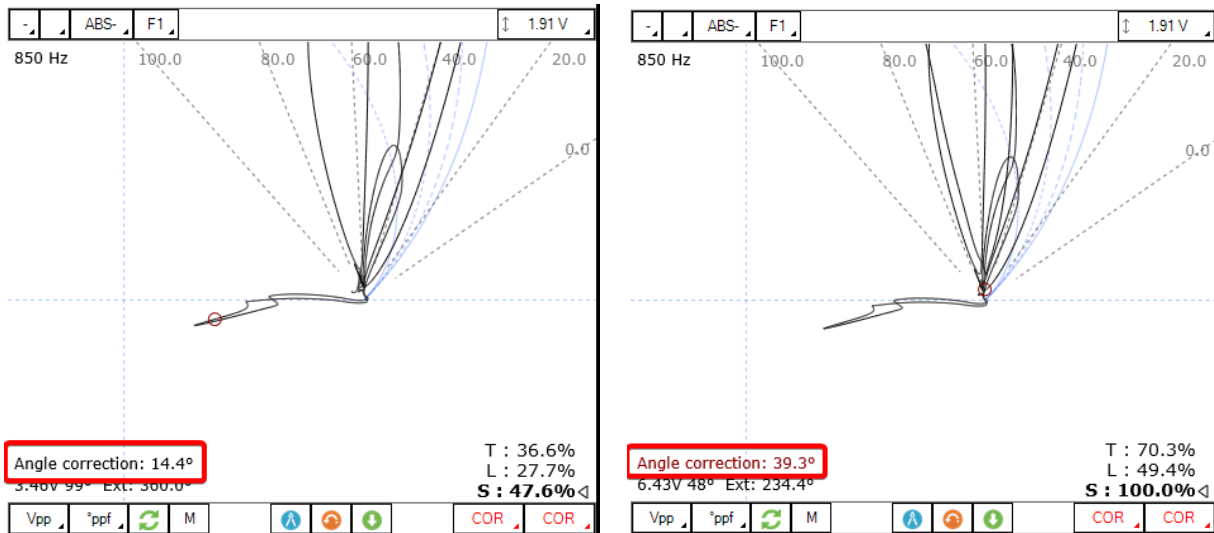

A common practice is to set the threshold angle correction value at +/- 30°. To change this default value, click on the Voltage Plane window to highlight its borders and change the Tolerance field under the Current View tab.

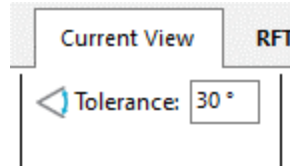

Outside this value, the inspection frequency should be adjusted. This is described in more detail in Appendix 1 of this document.

## CALIBRATION

Calibration is used to set the amplitude(s) and phase(s) of a channel using the selected measurement method. Given the options selected in the Probe Selection step of the Setup Wizard, the calibration of the bobbin channels can be performed with either the Lissajous or Voltage Plane, and the array channels can be independently calibrated if the *Manual* link type was chosen. All methods of calibration are shown below.

### LISSAJOUS

1. On either the conventional absolute (ABS\_F1 or ABS\_F2) or differential (DIF\_F1 or DIF\_F2) bobbin channel, position your cursor on the defect or feature corresponding to the calibration reference. In the picture below, the through-hole is selected. Make sure that the measurement vector includes the ends of the signal.

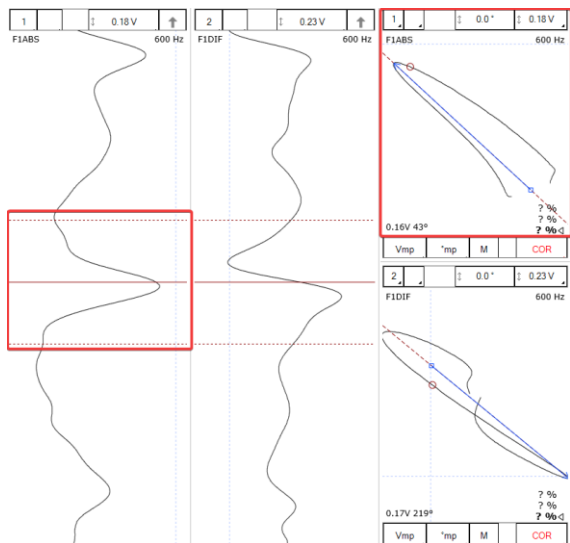

Absolute Lissajous before calibration

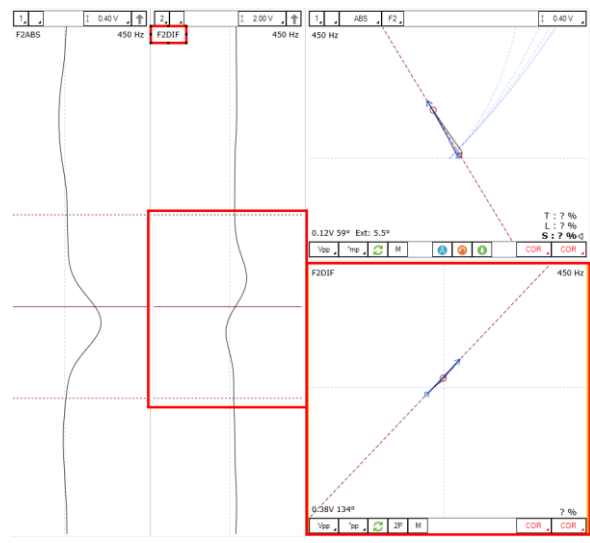

Differential Lissajous before calibration

2. Click the *System* button under the Calibration tab.
3. Select the *Channel* radio button.
4. Select the item that corresponds to your calibration reference from the list.

5. Then press the green arrow. This action tells the system that the previous measurement matches the selected reference.
6. Click Calibrate. This will apply the gain and rotation necessary to bring the reference signal to the desired value.

If you have calibrated the hole to 1V, 90°, the signal after calibration should look like the images below:

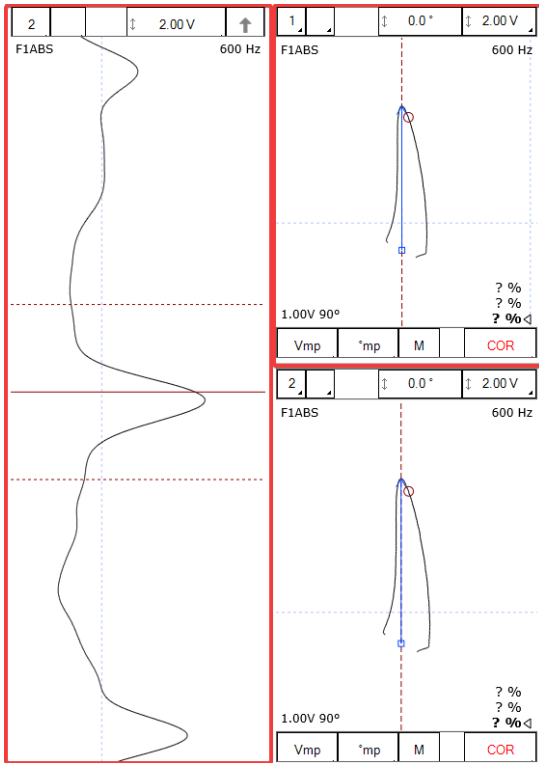

Absolute Lissajous after calibration.

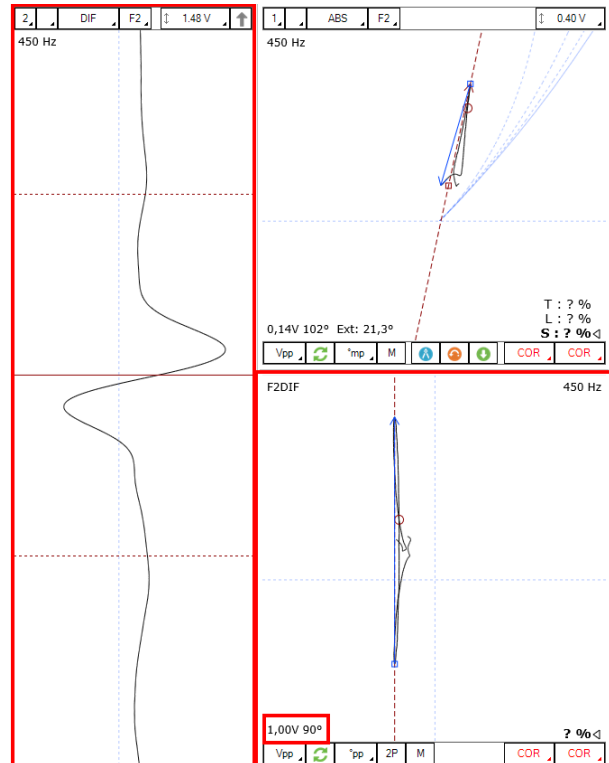

Differential Lissajous after calibration.

## VOLTAGE PLANE

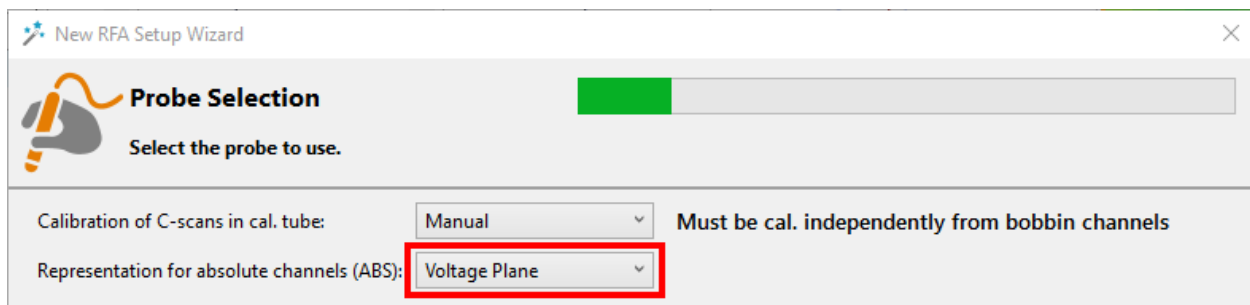

14. To adjust the signal, the user must manually draw a vector on the voltage plane from the nominal point of the calibration tube signal to the point of full attenuation (the effect of a completely blocked signal). Its length must initially be set to twice the length of the support plate, in the case of a Dual-Driver probe. To draw this vector, click on the manual measurement button "M", click

on the operation point of the signal, hold the left button of the mouse and drag it to the desired location. Once the vector is correctly drawn, click on the normalize button (blue compass). Magnifi will put the origin of the vector to the theoretical nominal point. It will apply a gain of  $1/(\text{vector amplitude})$  and a phase rotation of  $-(\text{vector phase})$ . If, for instance, the drawn vector has an amplitude of 0.8 and a phase angle of  $10^\circ$ , the system will apply a gain of 1.25 ( $1/0.8$ ) and a rotation of  $-10^\circ$  to the system.

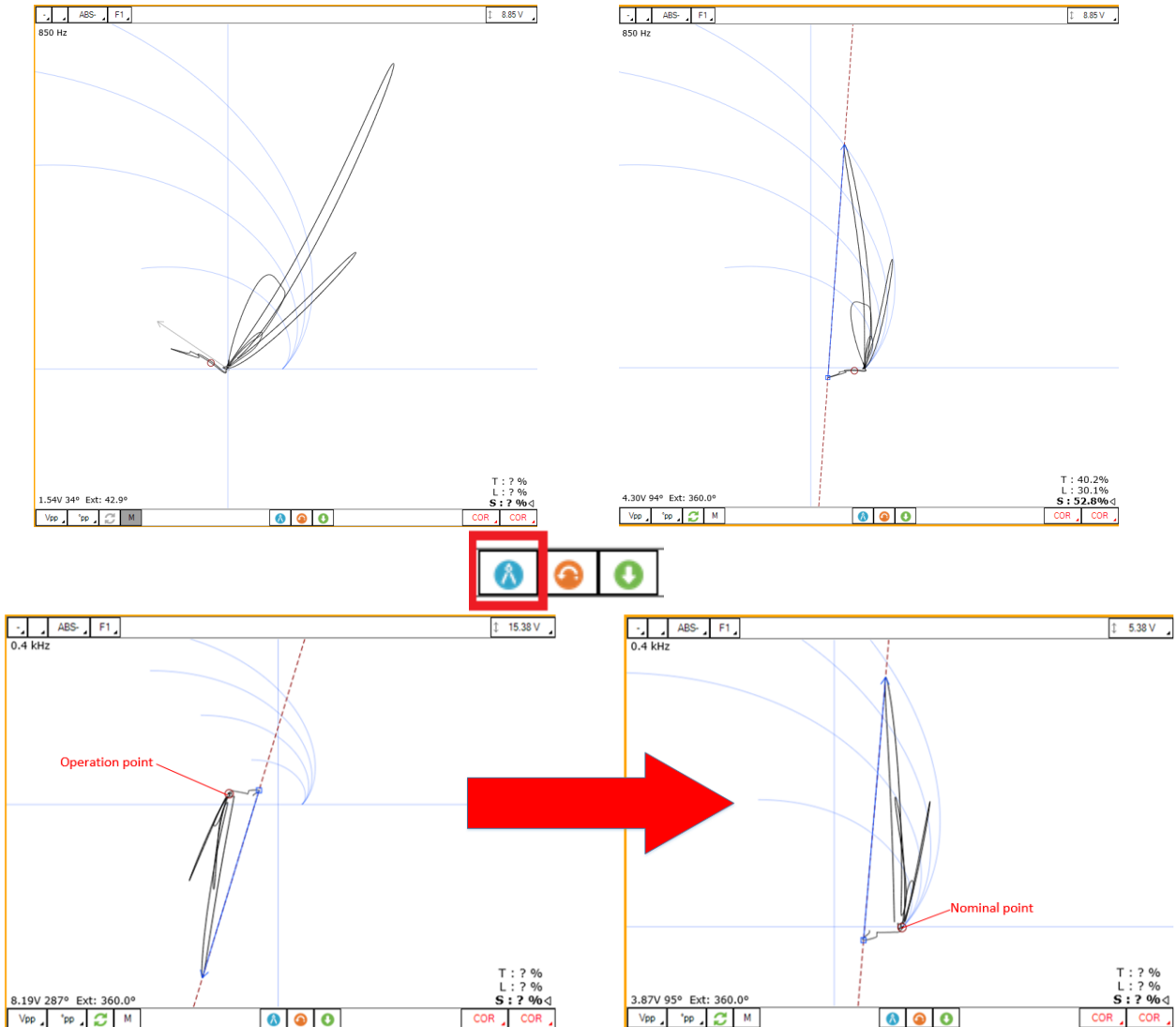

15. The signal may not be perfectly adjusted after the previous steps. You can adjust the signal again by drawing a new vector and by clicking on the normalization button until the signal is set correctly. In the examples below, the calibration tubes included two  $360^\circ$  grooves and we can see that both grooves reach the theoretical  $360^\circ$  coverage line. This can be a relevant indication to determine if a voltage plane is calibrated correctly.

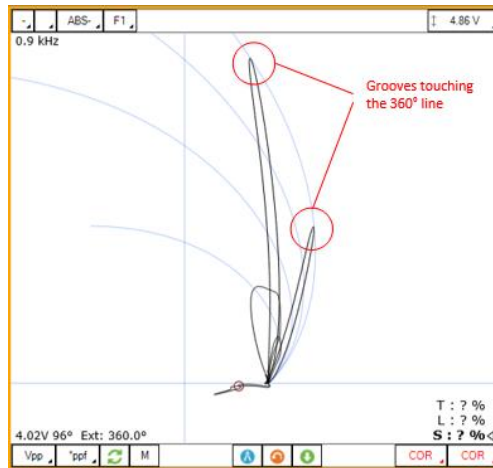

16. Save your calibration by clicking on the green *Save Nominal* button.



### ARRAY CHANNEL – AUTOMATIC LINK TYPE

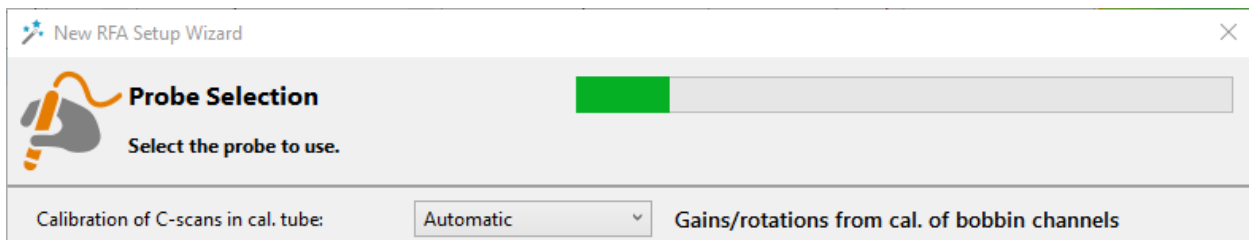

With the *Automatic* link type option selected during setup, the settings made on the bobbin channels will be copied to the array channels; meaning the gain and rotation applied to the bobbin channels (absolute and differential) will be also copied to the array channels. Therefore, no action needs to be taken to calibrate the array channels. The example below shows how the array channels get calibrated side-by-side with the conventional bobbin channels.

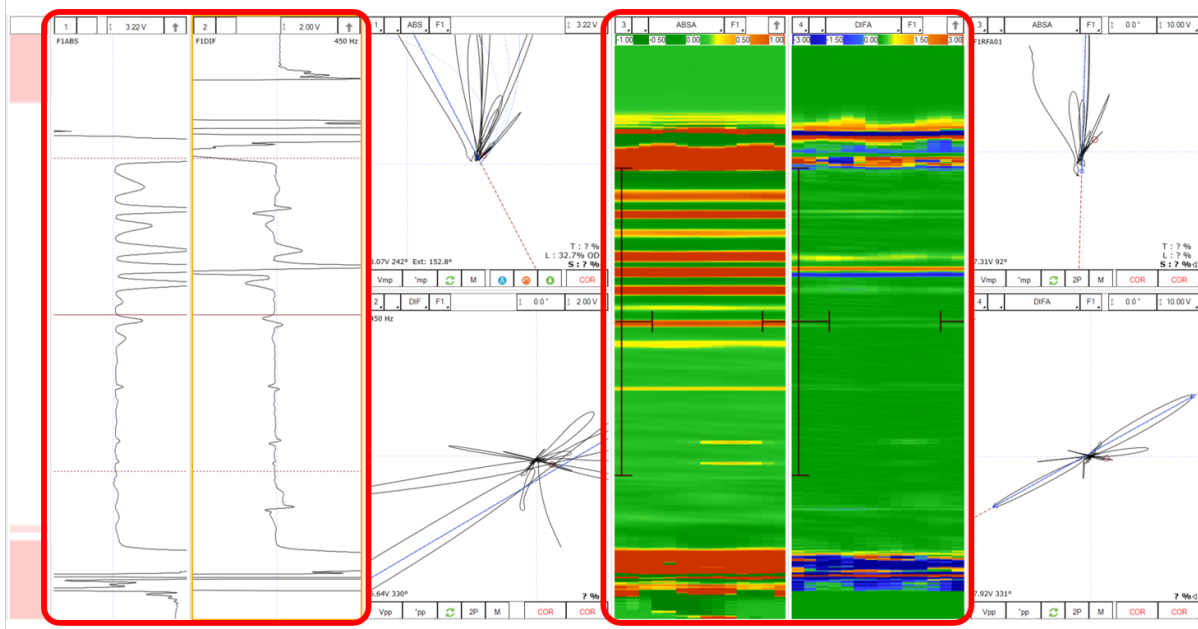

Above, calibration has not been applied to either channel. Below, the calibration was applied to the conventional bobbin channels which has been automatically pushed to the C-scan channels.

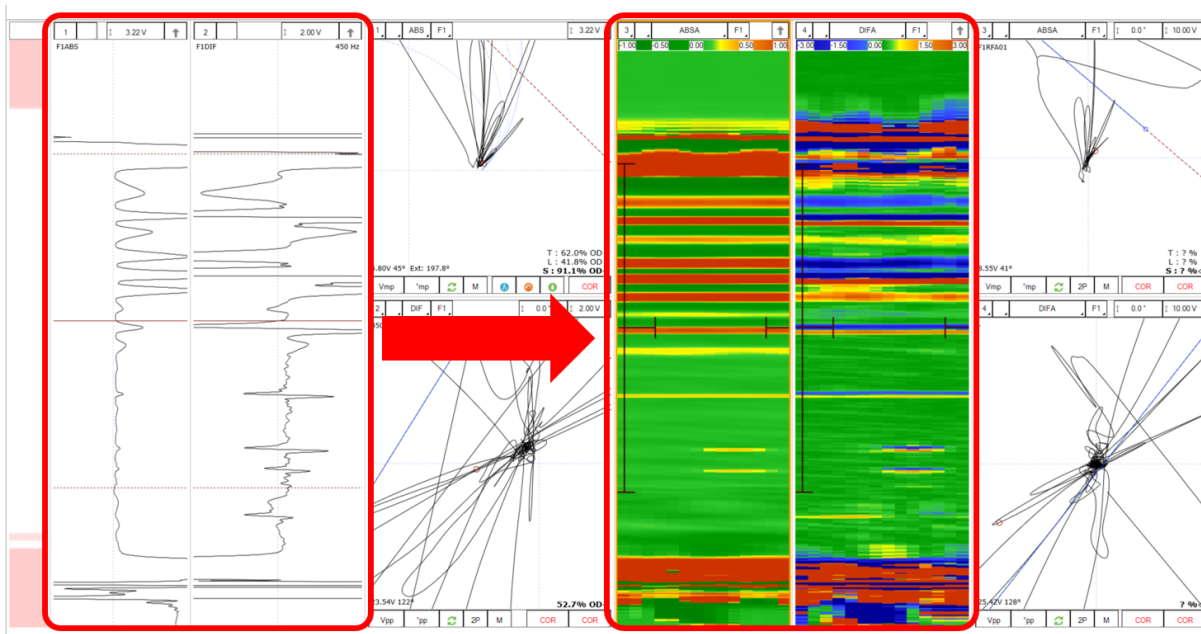

### ARRAY CHANNEL – MANUAL LINK TYPE

New RFA Setup Wizard ✕

**Probe Selection**

Select the probe to use.

Calibration of C-scans in cal. tube:

Manual

Must be cal. independently from bobbin channels



With the *Manual* link type option selected during setup, you must manually calibrate the array channels according to the following steps.

1. On an array channel, position your cursor on the defect or feature corresponding to your reference for your calibration. In the image below, the through-hole is selected on the array.
2. Make sure that the angle of the measurement vectors is oriented correctly on the array channels. The vector should include the signal ends on the differential. On the absolute, it should start from the nominal point and go to the signal end.

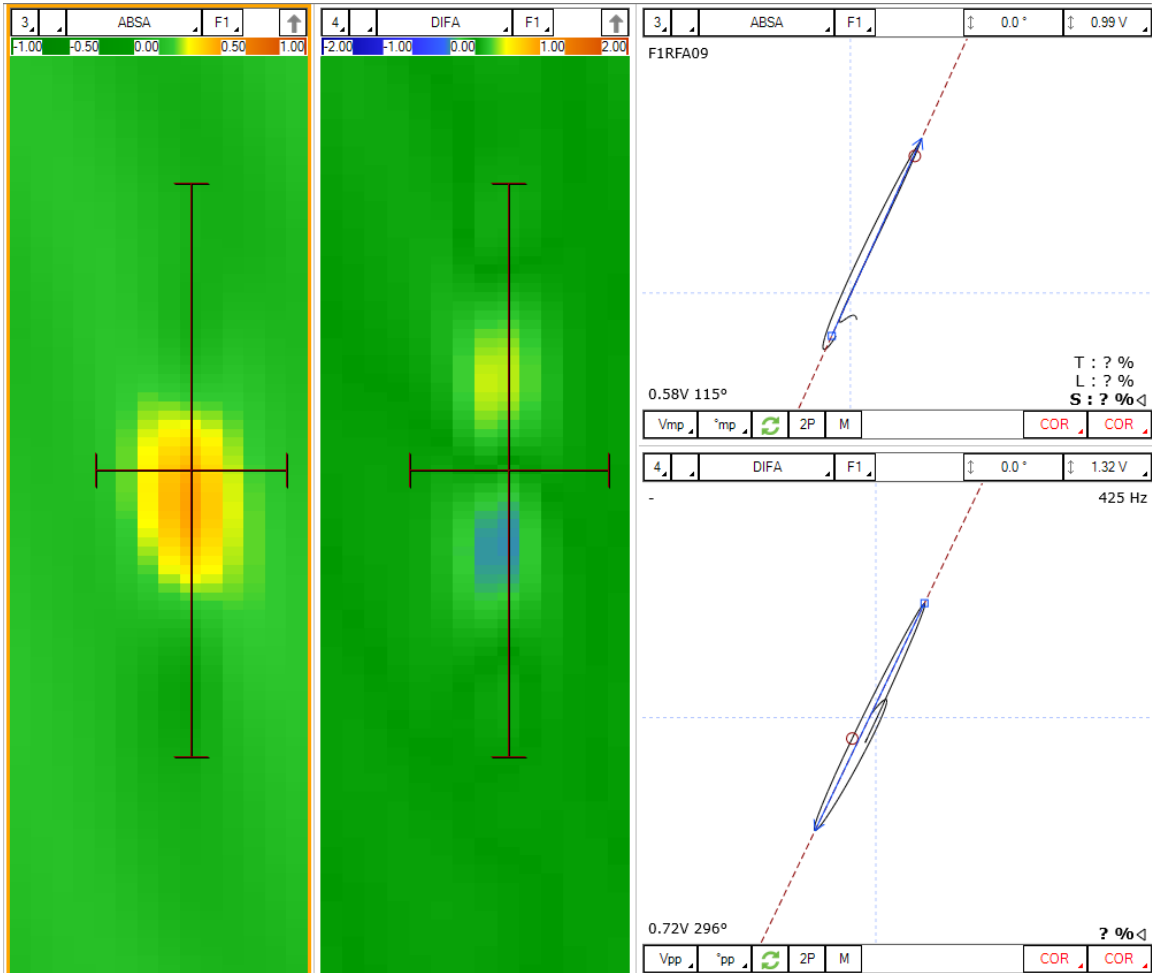

3. Press the *System* button under the *Calibration* tab.
4. Select the C-Scan radio button.
5. Select the item that corresponds to your calibration reference from the list.
6. Then click the green arrow. This action tells the system that the previous measurement matches the selected reference.

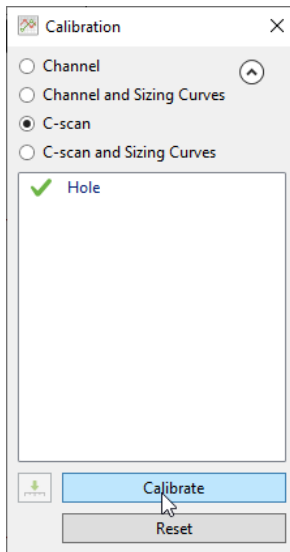

7. Click Calibrate. This will apply the gain and rotation necessary to bring the measured reference signal to the desired value

If you have calibrated the hole to 1V and 90°, the signal after calibration should look like the image below:

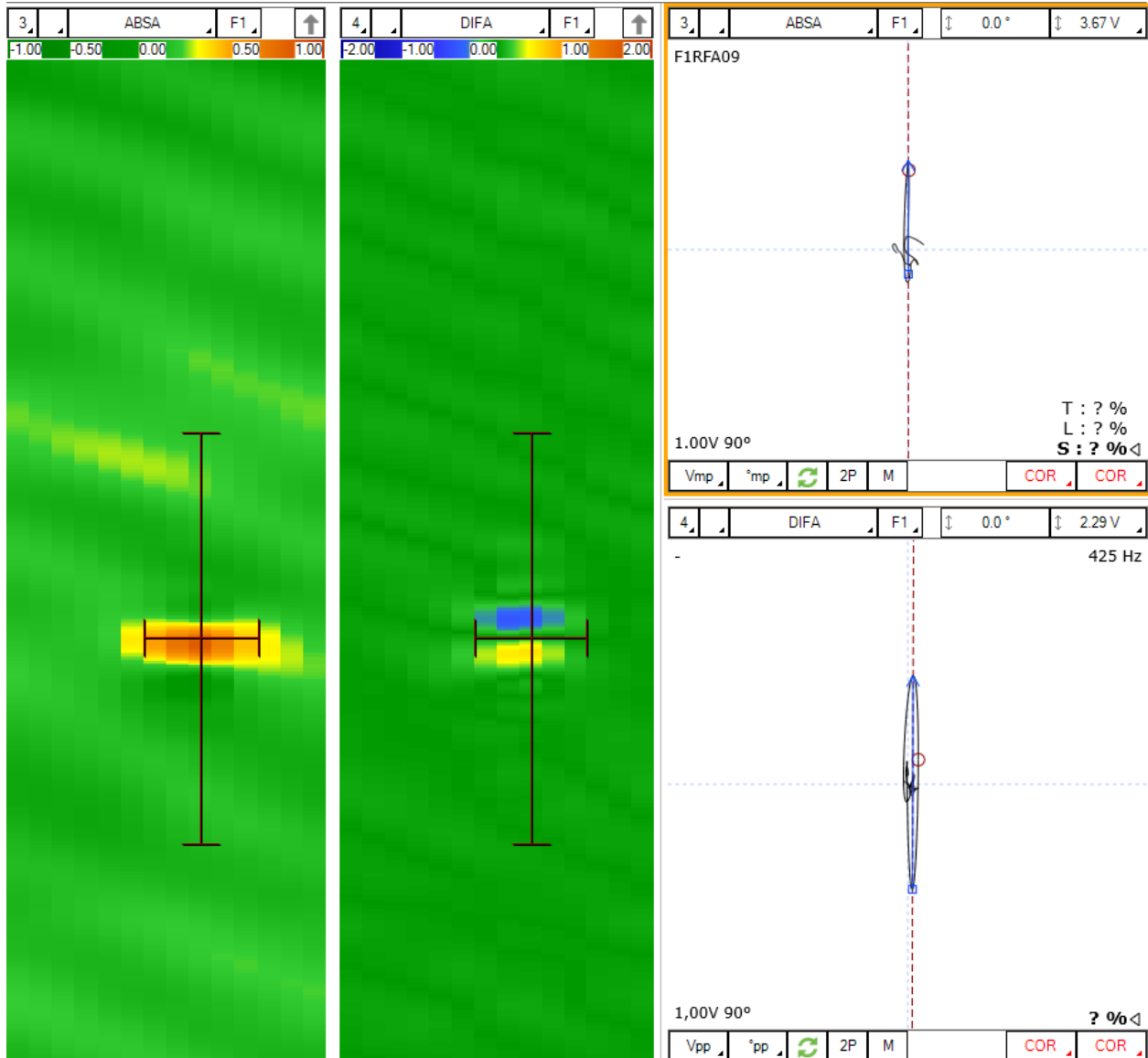

## CALIBRATION RESET

A calibration reset will reset changes made to the software gain and rotation, while preserving the sizing curves that have been previously created. To perform a soft reset, follow the steps below:

1. Under the *Calibration* ribbon, select the *System* menu. For both the *Channel* and *C-scan* radio buttons, click the “Reset” button to remove the stored information.

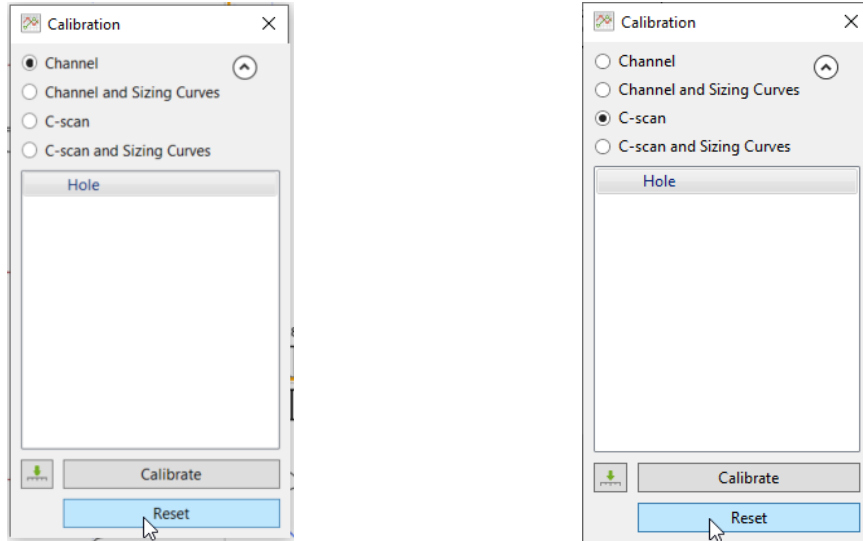

2. If you have chosen the Voltage Plane representation for your setup, select the voltage plane in Magnifi. Under the *Current View* ribbon, click on the “Reset Nominal” button. Note that you must perform this step individually for both frequencies. To do so, change the displayed frequency from the Voltage Plane view and then click on the Reset Nominal button again.

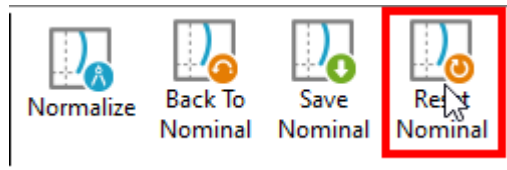

3. The final step to completely remove calibration information from the current setup is to reset the manual rotation applied to the C-scan Lissajous. To do so, click on the rotation button, hold the left button and drag the mouse up or down until the display value is 0. Do this for all array channels.

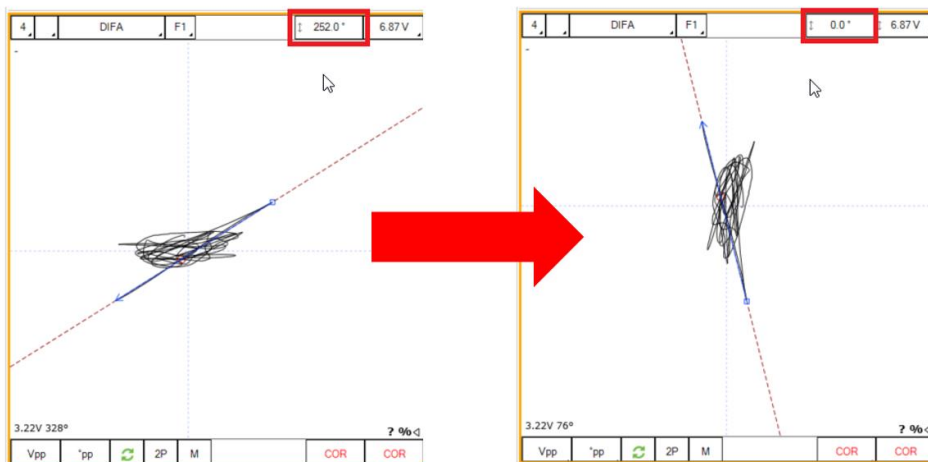

After performing the steps above, the calibration reset has been completed.

## SIZING CURVES CALIBRATION

The sizing curves allow the size of a defect to be estimated based on the calibration point signals (amplitude or phase) obtained with your calibration standard. Magnifi will give you the interpolated flaw size based on the sizing curves generated.

The default RFA setups come with predefined curves for bobbin and array channels.

To calibrate your sizing curves:

1. Go to Calibration tab and click on the System icon.

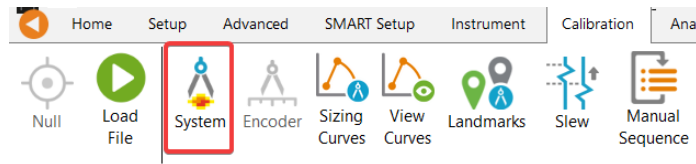

2. In the Calibration window,
  - a. If the sizing curve to calibrate corresponds to bobbin channels (ABS, DIF): Select Channel and Sizing Curves
  - b. If the sizing curve to calibrate corresponds to array channels (C-scan): Select C-scan and Sizing Curves

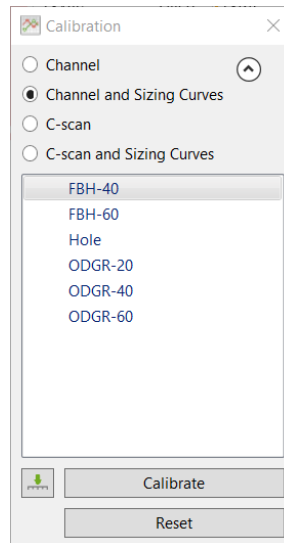

3. Place your cursor on the part of the signal that corresponds to an item in the list (on the strip chart or the C-scan).

*Note: The system calibrates the signal with a measurement method that is defined in the Sizing Curves Configuration page (under the Advanced tab). Therefore, it is recommended to read the data with the same method as the system when you select your calibration points. This will allow you to see what the system is using to make its calibration.*

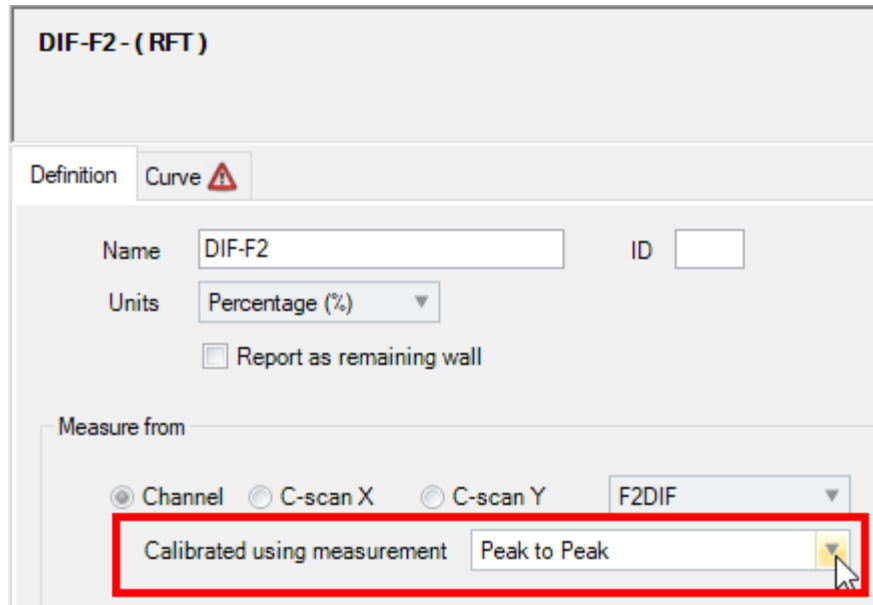

4. Select the associated signal name in the list.
5. Click on the green arrow.
6. Redo the previous steps for all the other indications in the list.
7. Click on the Calibrate button.

When one or more points were not measured correctly, Magnifi generates an error message to indicate the user that the sizing curve(s) could not be built. Here are some typical examples of problems that could arise during sizing curve calibration.

In the left image below, the blue measurement arrow is pointing downward towards the nominal point, instead of pointing up. In this case, the measured phase is rotated by 180° from the correct value. To correct the situation, the swap orientation button (green circling arrows) can be clicked before making the measurement during the calibration process.

In the image on the right, the arrow is pointing up towards the end of the defect signal, which is correct. However, the arrow starts quite far from the nominal point, which will cause an error in the measurement. In this case, we suggest adjusting the cursors until the measurement is taken from a point near the base of the defect signal.

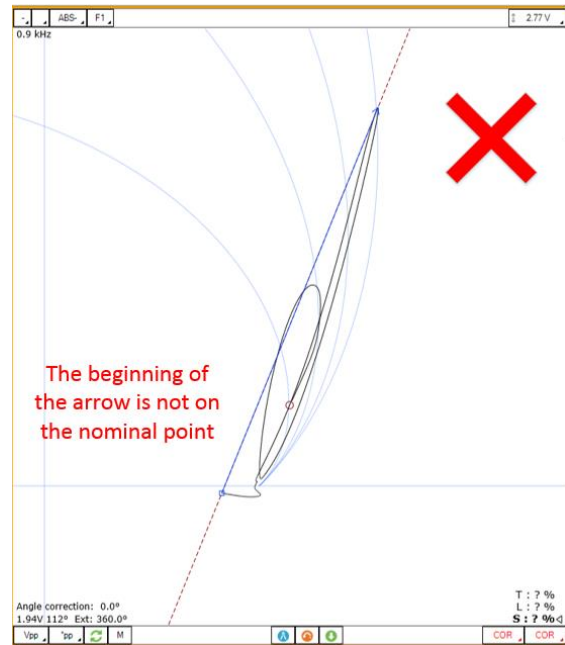
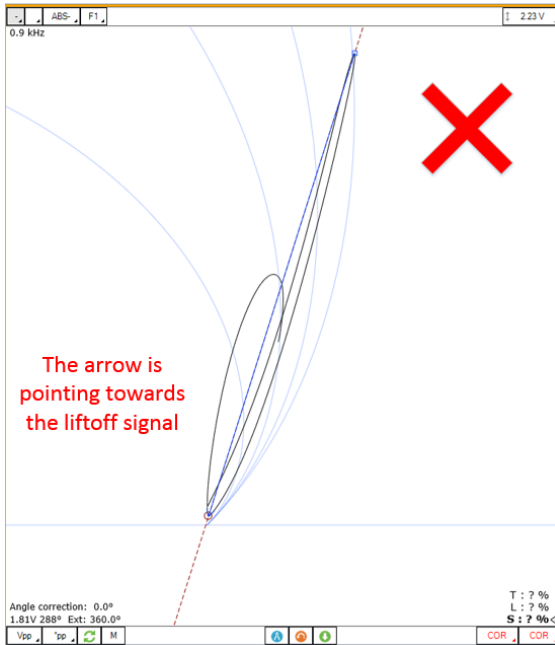

To readjust your sizing curves (e.g., if error messages were obtained during calibration), go the Calibration tab, and click on View Curves.

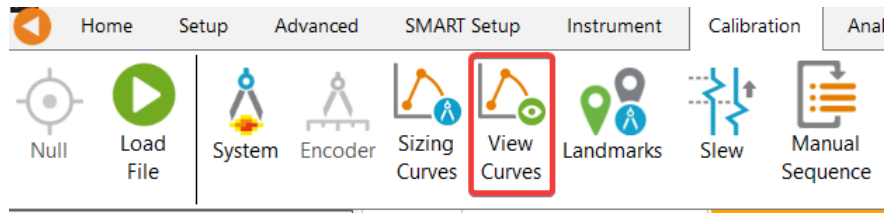

The sizing curve window will appear. Each sizing curve will be listed in the drop-down menu. If an invalid notification is present on the curve, it means that either the sizing points have not been entered yet or that Magnifi failed to create the curve. To adjust the sizing curve manually, enter the values in the table.

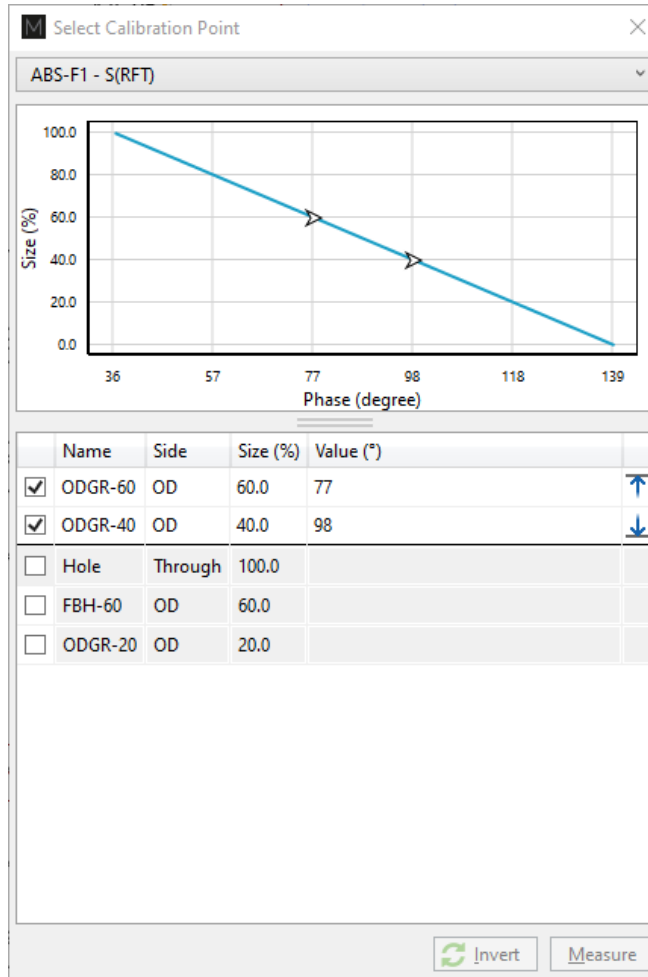

To validate that a curve works properly, bring the measurement cursor over a flaw's signal from your calibration tube and verify the value shown in the lower right corner of the Lissajous. It is recommended to use the same measurement method as the one that was used to build the sizing curve. To change the measurement method, click on the icons at the bottom left of the Lissajous.



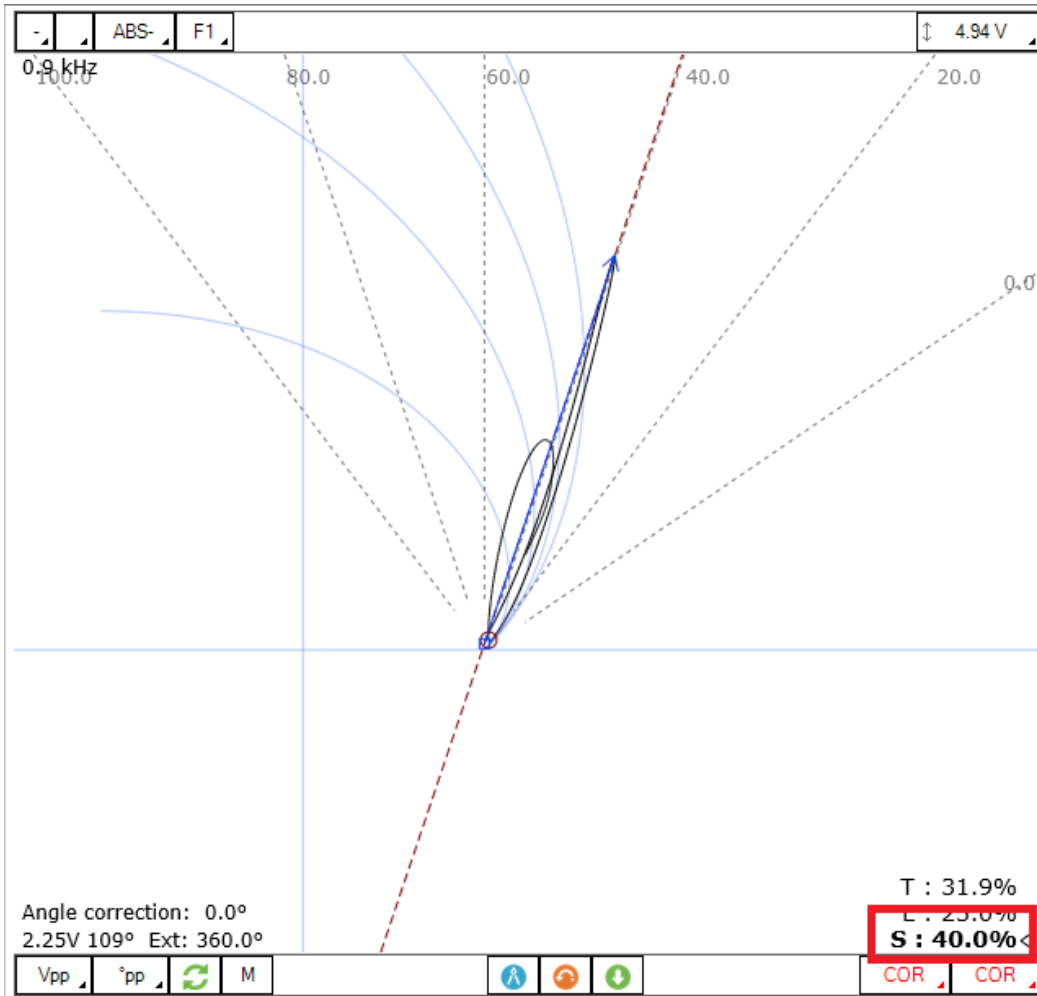

If the default size does not appear, it means that you are not displaying a channel where a sizing curve has been defined.

Built sizing curves can give you access to the phase-depth sizing overlays on the Lissajous and the Voltage planes. To activate this option, click on a window, go to the Current View tab and check the Depth-V. checkbox.

## LANDMARK CALIBRATION

This section describes how to calibrate your landmarks.

1. Go to the calibration tab and click on the Landmarks button.

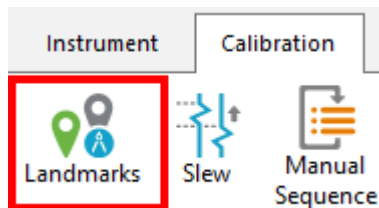

2. Calibrate the landmarks shown in the Landmarks window the same way the sizing curve(s) points were calibrated. You can use the Land channel to do so.

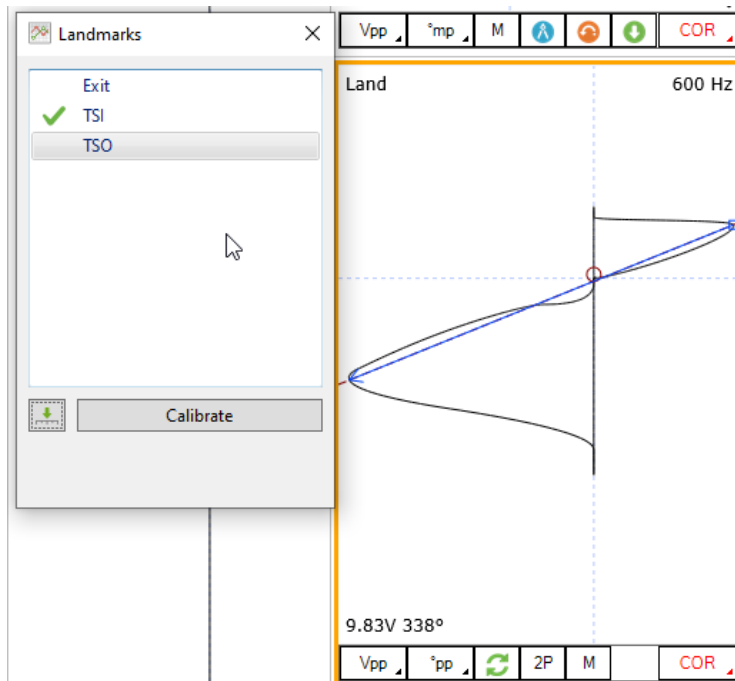

The positions of TSI and TSO are described in the Landmark window in the Setup tab (TSI is on the far-side tube sheet, that is, the first one encountered by the probe while pulling it during data acquisition; TSO is on the near-side tube sheet).

Once the landmarks are calibrated properly, the system should be able to recognize them automatically and the name of the landmark will appear in the Code view with a blue triangle.



*Note: In order to calibrate the default Exit landmark, data that includes the probe exit at the far end of the tube is needed.*

## FAST NORMALIZATION SETTINGS

Material properties, such as relative permeability, can change from one tube to another in the same tube bundle. This will cause a shift of the nominal point on the voltage planes and a rotation of the channels using a Lissajous. Consequently, the sizing curves calibrated with the reference tube will no longer be valid for these tubes. More information on this phenomenon can be found in Appendix 1 of this document.

If the angular movement of the signals is not too great (typically less than 30°), a common practice is to renormalize the absolute channels displayed on the Voltage plane (if this representation was chosen) and recalibrate the support plate signal to the reference obtained with the calibration tube for the differential channel.

As these operations are often performed several times during an inspection, Magnifi offers quick keys to facilitate the analysis.

To configure them, go the *RFT* tab and click on the *Settings Shortcuts* button. The displayed window will show the channels using voltage planes and standard scale process.

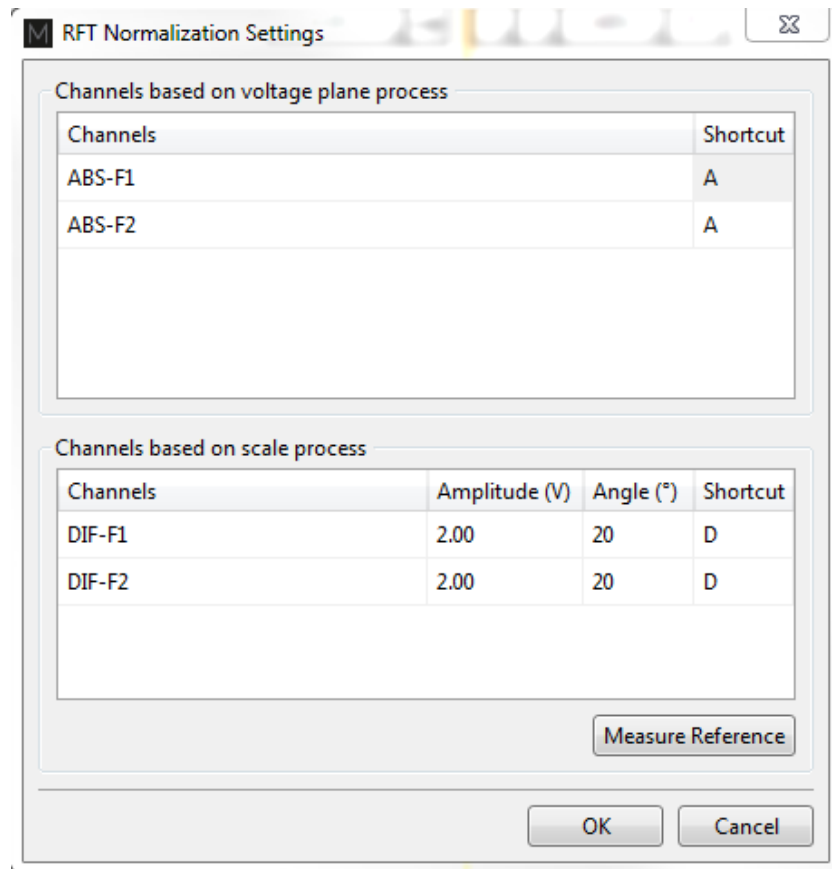

The keyboard shortcut next to the channels can be customized to normalize the associated channel. To set the reference values for channels using a Lissajous, select the reference indication signal with the cursors in your calibration tube data, then click on the Measure Reference button. The reference used in this case is normally the support plate.

## SAVING YOUR SETUP

Once all your setup adjustments are done, you can save your setup by clicking on the Save Setup button under the *Home* tab. The displayed window will allow you to give an appropriate name to your setup and to save it to the desired location. The save location is, by default, your inspection sub-folder. Note that when data are saved, the setup is also saved with it.

You can also save the data of your calibration standard by clicking on the Save As button under the *Home* tab.

## PERFORMING AN INSPECTION

Once you have used the Setup Wizard to create a setup, calibrated the data from your calibration standard, and created your sizing curves, you are now ready to perform an inspection.

Perform a preliminary scan of the tube bundle using the frequency estimated from the equation on page 271. Be sure to renormalize the signal again to ensure the selected frequency is appropriate by checking if the angle correction is within the set tolerance.

Renormalization and recalibration during the data-taking process is simplified with the shortcut keys you defined earlier. To renormalize the channels using the voltage plane process, select a sound area in the inspected tube and enter the keyboard shortcut you selected earlier for the fast normalization settings.

To recalibrate the channels using the standard scale process, select the reference (normally a support plate) and enter the keyboard shortcut. The system will adjust the selected reference to the value set in the *RFT Normalization Settings* window (*Amplitude* and *Angle*). Note that these operations should be performed using the conventional channels, not the array channels. The gains and rotations made on the conventional channels will also be applied to the array channels.

Whenever any hardware settings are changed, be sure to re-null the probe in the calibration tube before performing another acquisition.

## DATA LIST MANAGEMENT

For each acquisition, Magnifi can automatically save a file using the file name defined previously in the *Data List* section of this document. To do so, checkmark the *Automatic File Recording* option that can be found under the *General* tab of the *Preference* menu of the *Backstage*.

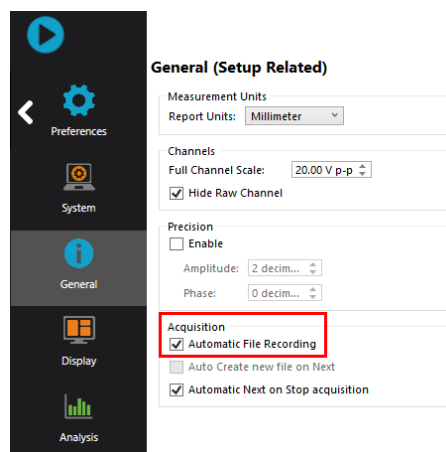

The list of tubes is also shown in the *Data* window.

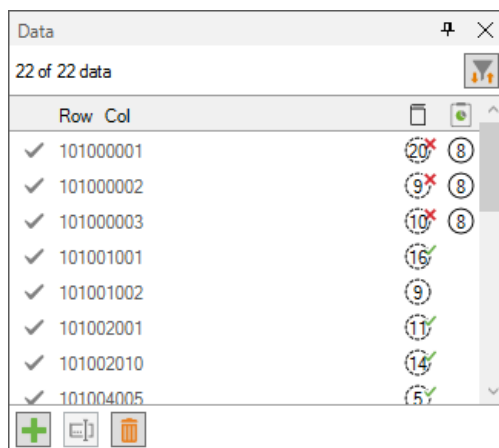

A common practice is to rescan your calibration tube and balance the probe periodically. You can save this new calibration tube data by adding a new tube in your tube list (999 001 for example). Or you can exit out of acquisition mode, scan your tube, and click on the *Save Cal As...* button under the *Calibration* tab to save your data. You can then go back to *Acquisition Mode* to continue your inspection and to automatically save the acquired tubes in your bundle.

Once a tube has been scanned, the "play" icon next to the file name will be replaced with a checkmark icon.

You can rescan a tube by selecting its name in the list and by clicking on the *Rescan* button in the *Home* tab.

A tube name can be changed by right-clicking on its name and by selecting the *Rename* option.

## LOADING A FILE

17. First disconnect your computer from the Ectane by clicking on the *Disconnect* button under the *Home* tab (optional step).
18. You can load a file by double-clicking on the file name in the *Data* window. It can also be done by selecting the file in the list and by clicking on the *Load* button under the *Home* tab. Note that double-clicking on a tube when you are still connected to an instrument will initiate data acquisition.
19. You can open the next or the previous file in the list by clicking on the *Previous* or *Next* button of the *Home* tab.

The data files can be filtered by using the *Filter* button of the *Data* window.

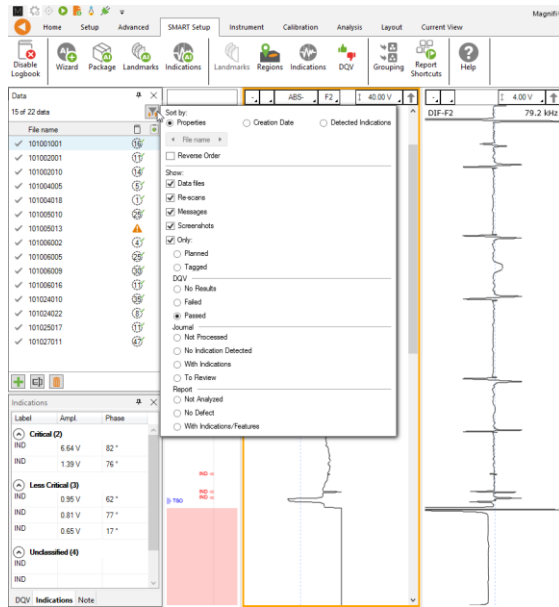

## REPORT

### INDICATIONS

The two *Indication* buttons in the lower-right corner of the Lissajous view can be used to add an entry to the report. These two buttons indicate the code that is associated with the defect being entered. Both buttons are identical, but can be set to identify different flaws.

To add an indication to the data:

20. Select the defect signal in the strip chart and adjust the cursor so that the signal in the Lissajous includes only the defect signal.
21. Then, click on the red triangle in the corner of the *Indication* button to select the type of defect to enter.
22. Click on the defect button to add an entry to the report.

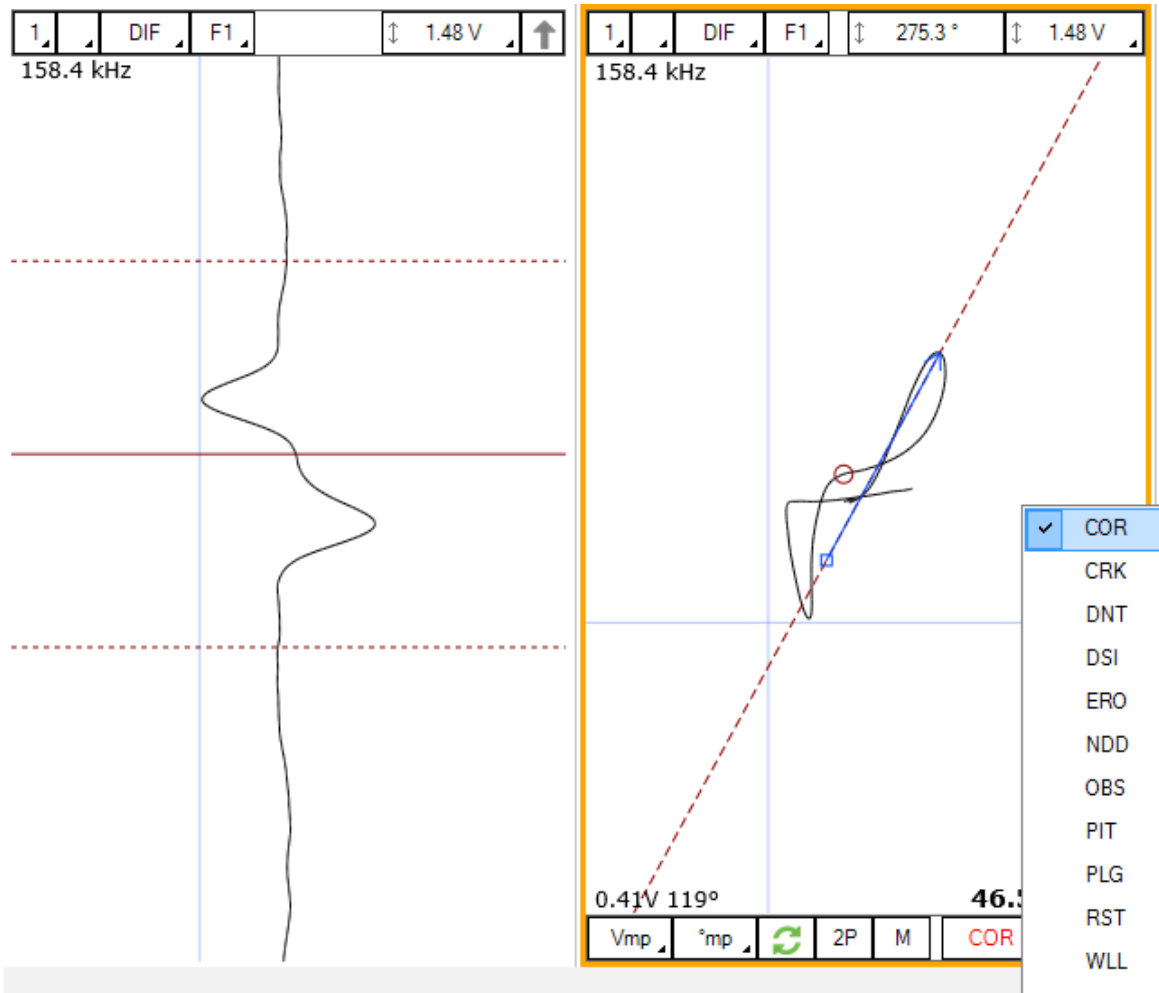

Report entries can also be added using keyboard shortcuts. The SMART Setup section of this manual explains how to configure them.

Another type of report entry, called “feature”, can also be added to a tube to indicate, for instance, that it has no flaw or that it is plugged. A feature is an indication that is general to the tube, it is not localized like defects, and therefore has no measurement or size associated with it. To add a feature to a tube:

23. Load the file

24. Click on the appropriate indication button available under the Analysis tab

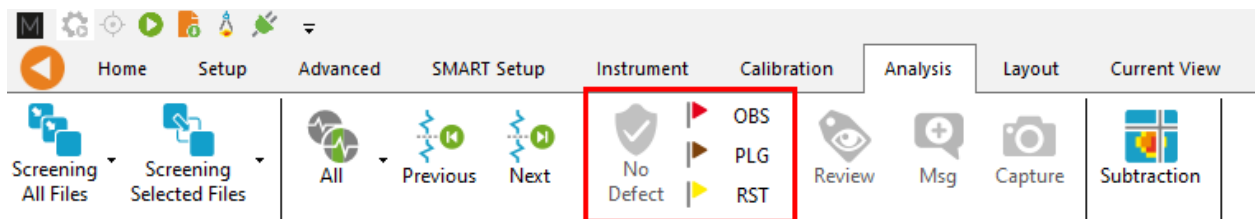

## REPORT TABLE

To access the list of indications entered:

25. Make sure that the Report option is selected under the Layout tab.

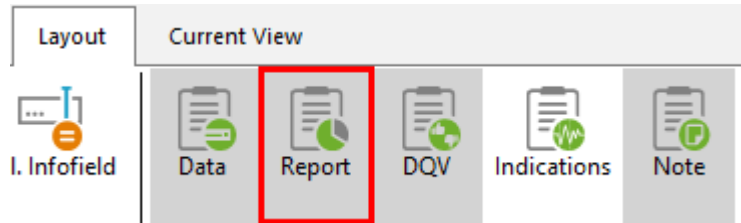

26. Click on the report tab at the bottom of the screen to make the list visible

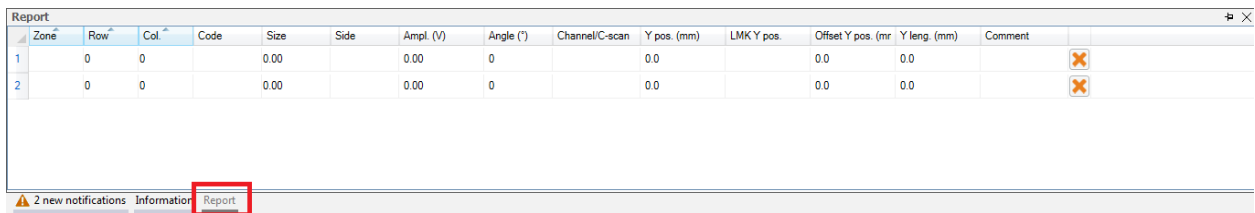

Zone	Row	Col.	Code	Size	Side	Ampl. (V)	Angle (°)	Channel/C-scan	Y pos. (mm)	LMK Y pos.	Offset Y pos. (mm)	Y leng. (mm)	Comment
1	0	0		0.00		0.00	0		0.0		0.0	0.0	X
2	0	0		0.00		0.00	0		0.0		0.0	0.0	X

Entries in the report can be modified by changing the value in the table. You can also delete an entry by clicking on the X next to it.

## REPORT GENERATION

Magnifi can automatically generate a full report with the report table.

To generate this report:

27. Go to the *Backstage* by clicking on the arrow at the upper left corner of the *Frontstage*.
28. Click on the *Generate Report* button under the *Report* section of the *General* tab.
29. Choose your preferences and enter the required parameters. The *# of tubes in component* is used to show the percentage of tube in each category.



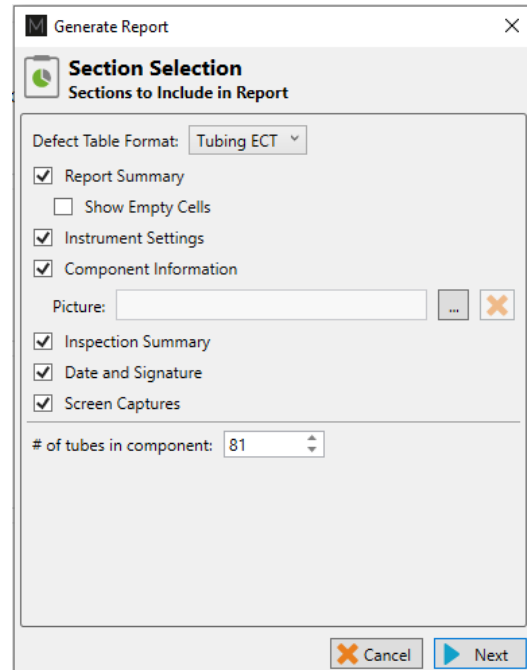
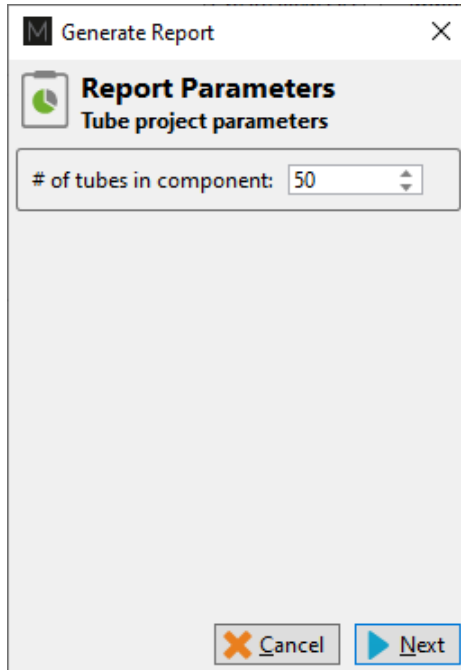

30. Click Finish to generate the report.

Once generated, the report is saved as a .html file in the current Inspection sub-directory. It can be viewed using any regular web browser.

There is a “copy” button next to each element of the report such as tables and images. When clicking on it, the element will be copied to the clipboard. It can then be pasted to another file such as an Excel or Word.

Name	Frequency (KHz)	Drive (V)	Gain (dB)	Low Pass (KHz)	High Pass (Cnt)
R_ABS-F1	160.0	2.50	46.0	400	
R_ABS-F2	80.0	2.50	46.0	400	
R_ABS-F3	40.0	2.50	46.0	400	
R_ABS-F4	20.0	2.50	46.0	400	
R_DIF-F1	160.0	2.50	46.0	400	
R_DIF-F2	80.0	2.50	46.0	400	
R_DIF-F3	40.0	2.50	46.0	400	

The Print button, bottom right corner on image above, can be used to either print a paper copy of the whole report or to save it as a .pdf document. The PDF generator available with the current web browser will be used.

10/10/2023 15:31 Magnifi Report

**Analysis Report**

Eddyfi Technologies

**Instrument Settings**  
Setup name: ECT-800bin

**Channels**

Name	Frequency (kHz)	Drive (V)	Gain (dB)	Low Pass (kHz)	High Pass (kHz)
R_ABS-F1	160.0	2.50	45.0	400	
R_ABS-F2	80.0	2.50	45.0	400	
R_ABS-F3	40.0	2.50	45.0	400	
R_ABS-F4	20.0	2.50	45.0	400	
R_DIF-F1	160.0	2.50	45.0	400	
R_DIF-F2	80.0	2.50	45.0	400	
R_DIF-F3	40.0	2.50	45.0	400	
R_DIF-F4	20.0	2.50	45.0	400	

Imprimer 4 pages

Destination Enregistrer au format f

Pages Tous

Mise en page Portrait

Plus de paramètres

Enregistrer Annuler

The report logo can be modified by clicking on the *Select Company Logo* that can be found under the *System* tab of the *Backstage*.

**System (Computer Related)**

Measurement Convention:  ASME,  ASME Inverted,  EDF

Measurement Units:  Metric,  Imperial

Readback:  Do not display data during loading

Speed:  Actual Inspection Speed,  Maximum

"Keep Current Setup" Button Behavior:  Retain check state,  Reset to checked after loading a data file

Setup Wizard Path: C:\Users\daube.QTEC\Documents\Magnifi\Setup

Automatic Features:  Allow to save setup in original location,  Ask to save setup when the first data file is recorded

Logo:  Preview: eddyfi

The report table file in the *Inspection* folder can also be imported into other reporting software such as *TubePro*.

## ADVANCED SETTINGS AND OPERATIONS

---

### ADVANCED SETUP MODIFICATIONS

The RFA Setup Wizard offers possibilities to generate your setup, but some options are not directly accessible with the Wizard. To access these modifications, it is necessary to use advanced menus.

#### MODIFICATION OF THE DEFAULT SCALE PARAMETERS FOR CALIBRATION

By default, if the absolute channels are represented with a Lissajous when generating setups with the RFA Wizard, and the calibration of the absolute channels is performed on the Support Plate indication signal by bringing it to 0.5V and 0°. For the differential channels, the calibration puts the signal of the Through-Wall Hole indication at 1V and 90°.

These settings are the same for both the bobbin and array channels.

If needed, these calibration parameters (reference point, amplitude or phase value and measurement method) can all be customized using the Advanced Channels and C-scans menus.

Reminder: If the conventional absolute channels are represented with the Voltage Plane, the calibration uses the Voltage Plane process. Therefore, it can't be customized.

#### Bobbin Channels:

1. To modify the calibration parameters for the bobbin channels: Click on Process Ch. under the Advanced menu.

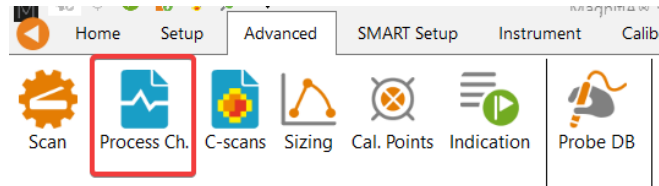

2. In the Data Processing page, select the page (ABS (Scale) or DIF) that you want to modify.

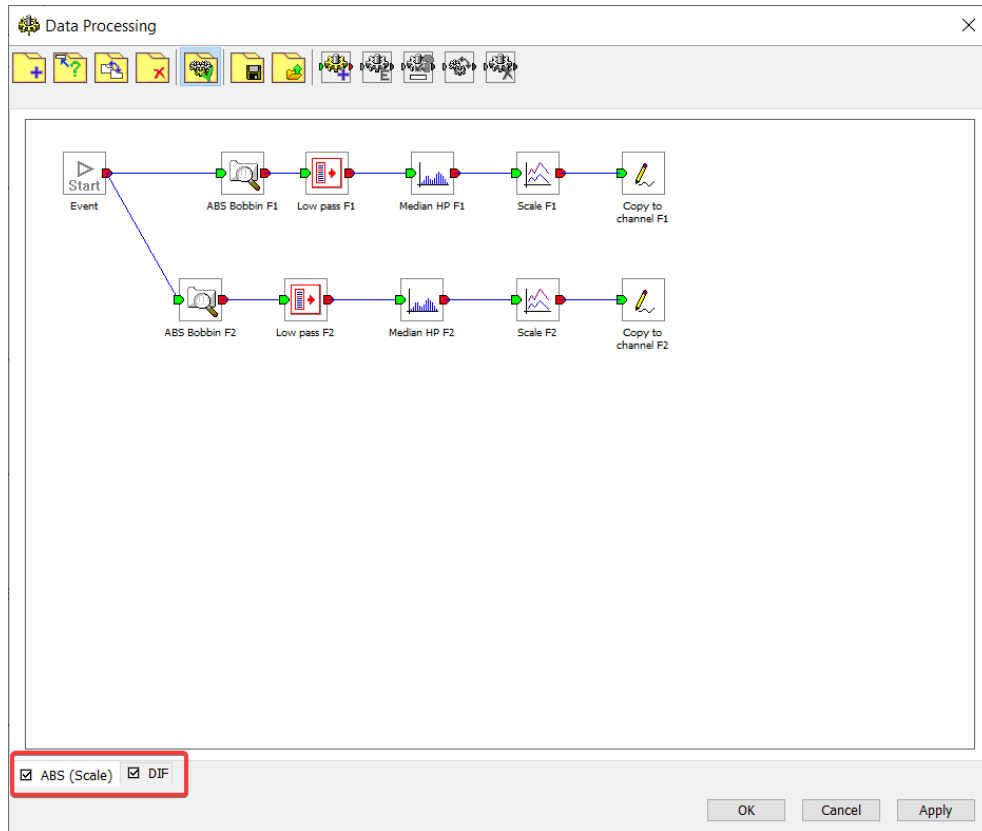

3. Double-click on the Scale icon for the channel that requires modification.
4. For both the Amplitude and Phase, you can change the targeted value, the reference point and the measurement method. Note that different reference points can be used to calibrate the phase and the amplitude independently.

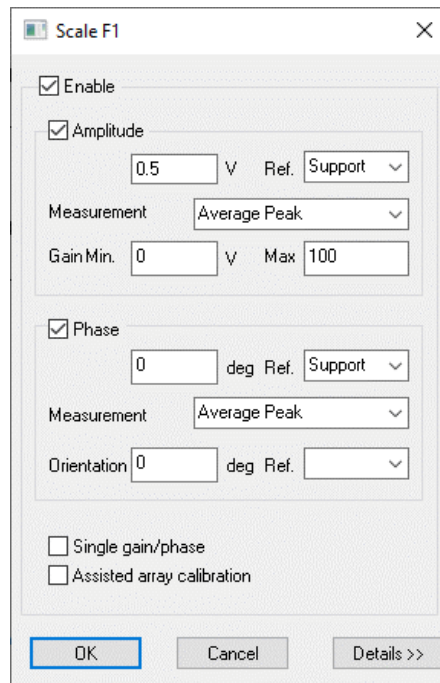
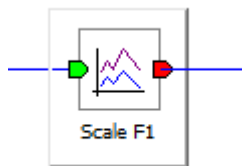

## Array Channels:

If the calibration mode for C-scans is set to Manual, the C-scans must be calibrated independently from the bobbin channels in the calibration tube. In that case, you might also want to modify the calibration parameters for the array channels:

1. Click on C-scans under the Advanced menu.

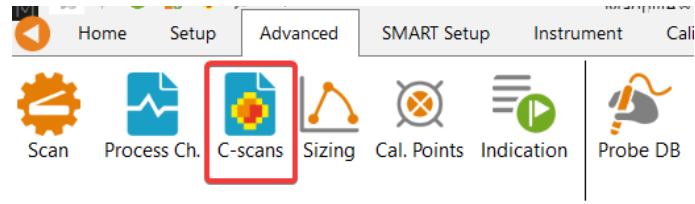

2. In the C-scan Configuration page, select the C-scan that requires modifications.

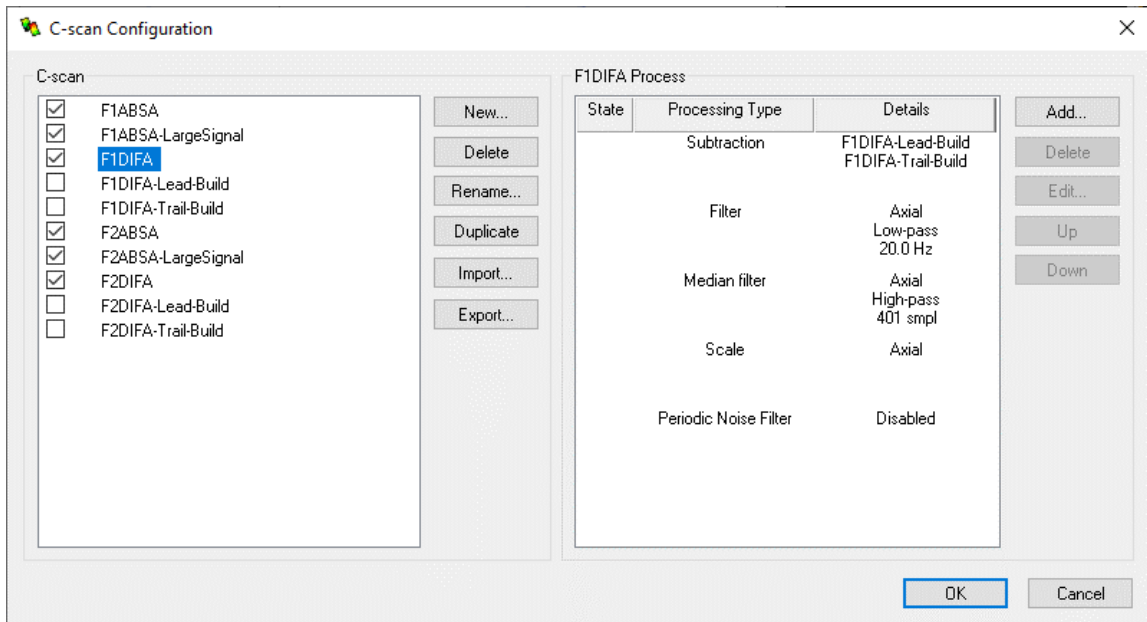

3. In the Process section associated with the selected C-scan, select the Scale process, then click Edit to open the Scaling Setup page.

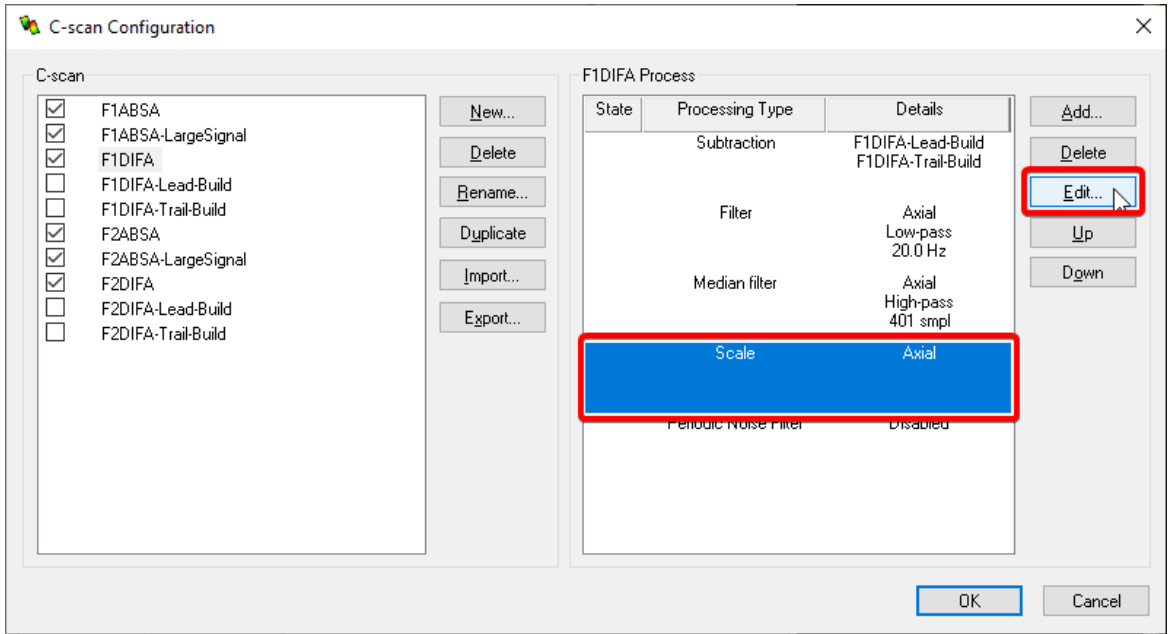

- For both the Amplitude and Phase, you can change the targeted value, the reference point and the measurement method. Note that different reference points can be used to calibrate the phase and the amplitude independently.

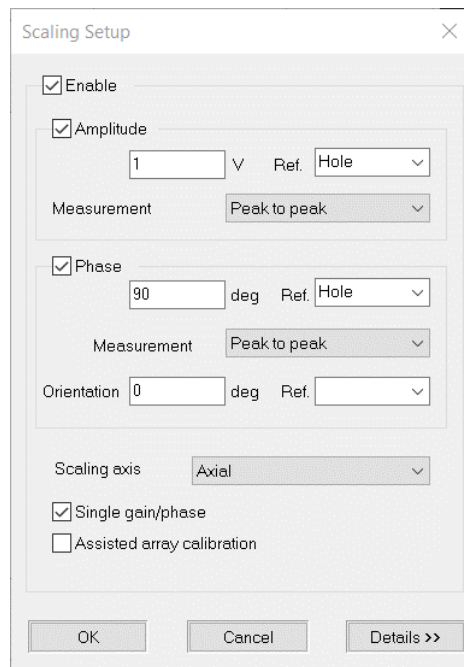

## SIZING CURVE MODIFICATIONS

In the Sizing Curves Configuration window (under the Advanced tab), you can either create a new curve by clicking on *Add*, or modify the general parameters of predefined curves such as measurement type,

channel source, etc. By default, all curves are measured using phase angle. However, they can be changed to amplitude.

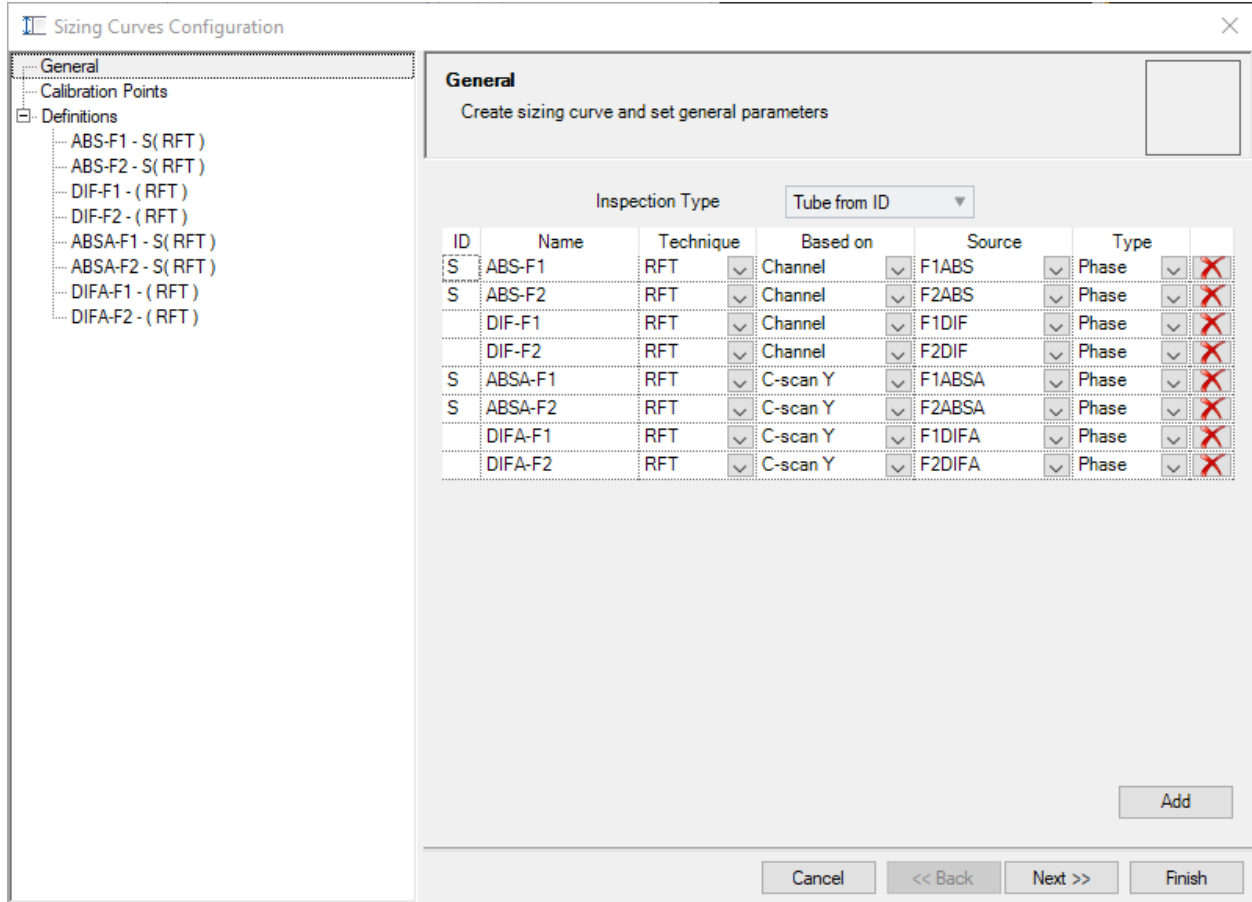

For every sizing curve seen under the General section, there will be a specific page in the *Definitions* section to configure the curve properties. By default, the Average Peak (MP) measurement method is set for the absolute channels, and the Peak to Peak (PP) option is used for the differential channels.

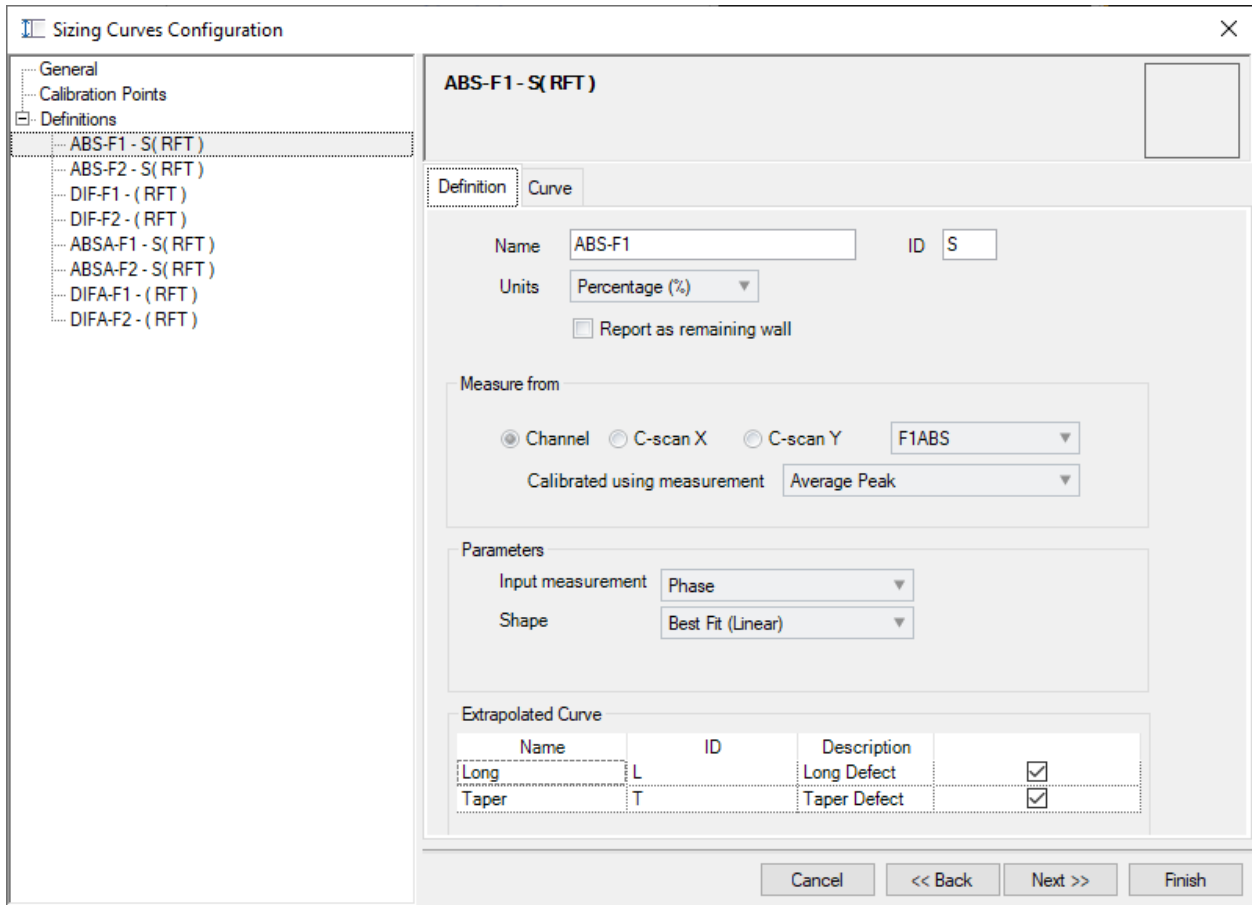

The plot of sizing curves for each individual channel can be seen by clicking on the Curve tab. From there, you can click *Select...* to see or modify the calibration points for each curve.

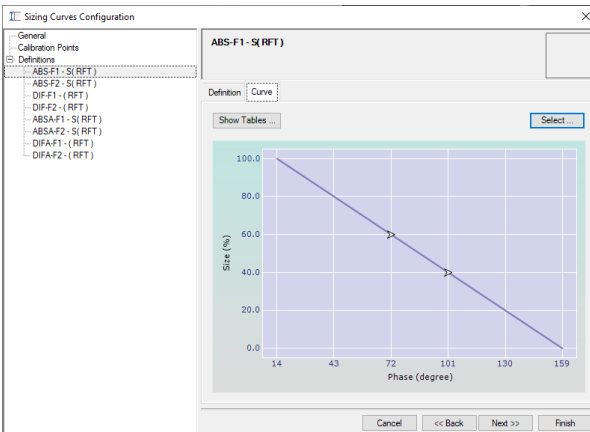

**Select Calibration Point**

	Name	Side	Size(%)	Value(°)	
<input checked="" type="checkbox"/>	ODGR-6	OD	60.0	72	↑
<input checked="" type="checkbox"/>	ODGR-4	OD	40.0	101	↓
<input type="checkbox"/>	Hole	Throu	100.0		
<input type="checkbox"/>	FBH-60	OD	60.0		
<input type="checkbox"/>	ODGR-2	OD	20.0		
<input type="checkbox"/>	Support	Unkno			

Reverse Order **OK**

*Note: When you modify an existing curve or add a new curve, you must recalibrate/calibrate all sizing curves (channels and C-scans).*



## RFA LINKS EDITOR

The RFA Links Editor menu can be found under the RFT ribbon. The drop-down menu available at the top of this window shows the selected mode of calibration for the C-scans in the calibration tube, as initially defined during the Setup Wizard.

In the Links table, the left column shows the conventional bobbin channels, and the right column shows the C-scans associated to them. When a channel in this list is calibrated, or its software gain or rotation is modified, the same changes are automatically applied to the C-scans linked to it.

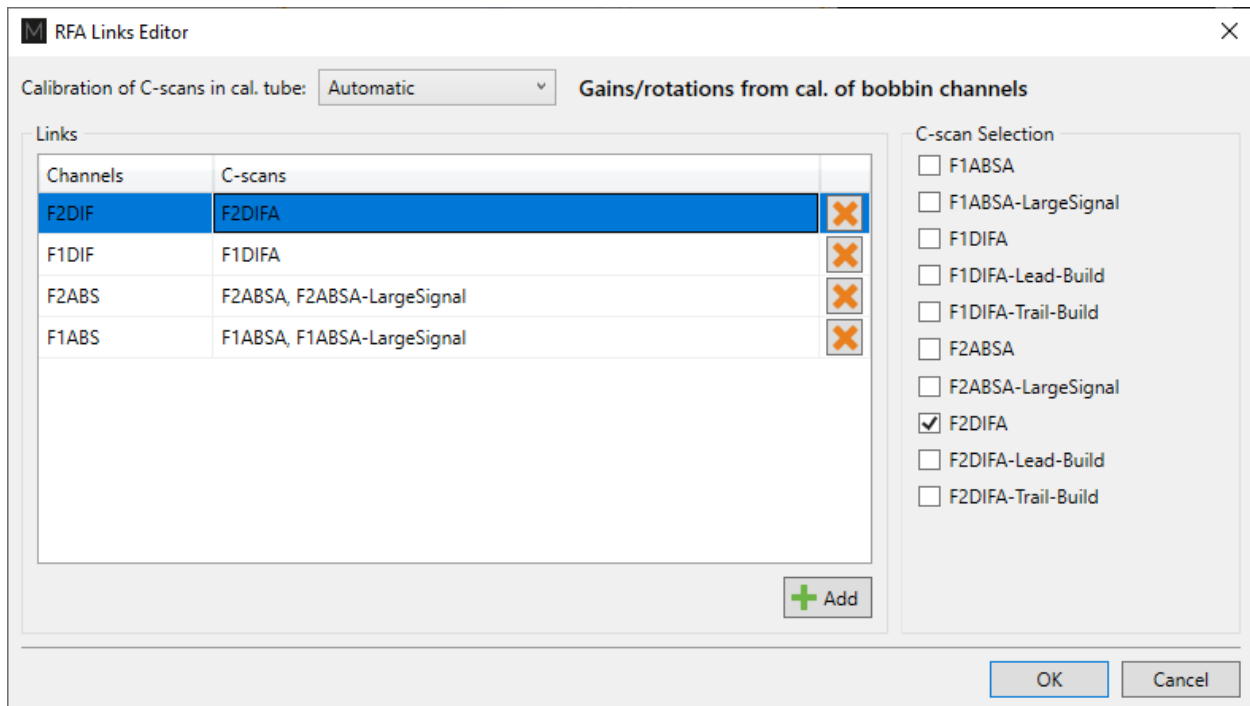

It is highly recommended to leave this menu as it is. However, it is accessible to allow for advanced customization of an RFA setups. For instance, should a new C-scan be added to a setup, this menu would allow to link it to the correct bobbin channel.

## LOSS OF COMPATIBILITY WITH THE RFA WIZARD

All the setup modifications covered until this point are considered as being a typical setup creation workflow for RFA technology. If additional customization of the setup is required for specific purposes, you should be aware that it might result in a loss of compatibility with the dedicated RFA Wizard.

Modifications made to the following menu would break compatibility:

- Advanced Scan Definition menu

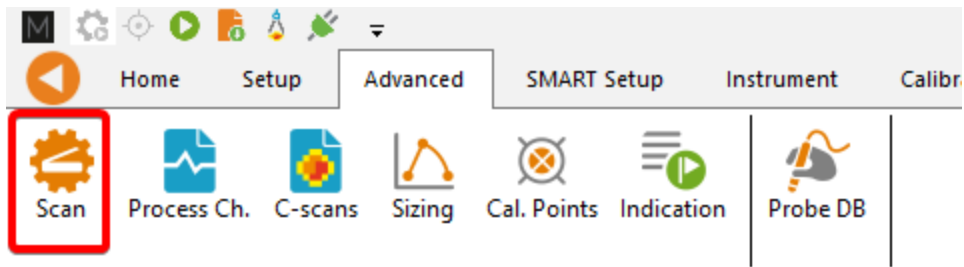

- Channels and C-scans Advanced Process menus: Modifications to processes other than the Scale (as shown previously)

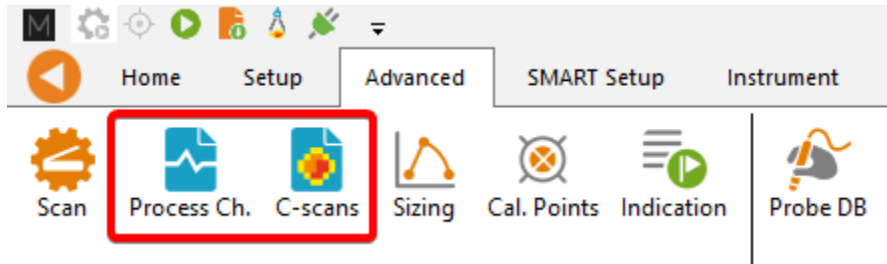

- Instrument Configuration menu

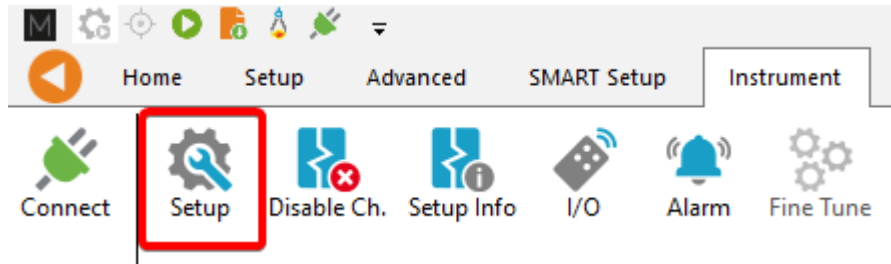

Important: If you need to make modifications to the above menu, you should stop using the RFA Wizard and only use the Advanced menus for all the adjustments to the setup, including the frequency selection, scan length, etc.

## SMART SETUP TOOLS

Additional functions, which facilitate data analysis, can be set up under the SMART Setup tab.

### LOGBOOK

The first button on the left side under the SMART Setup tab allows you to enable or disable the logbook.

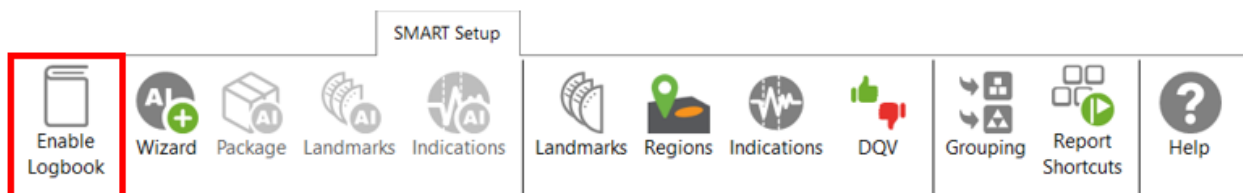

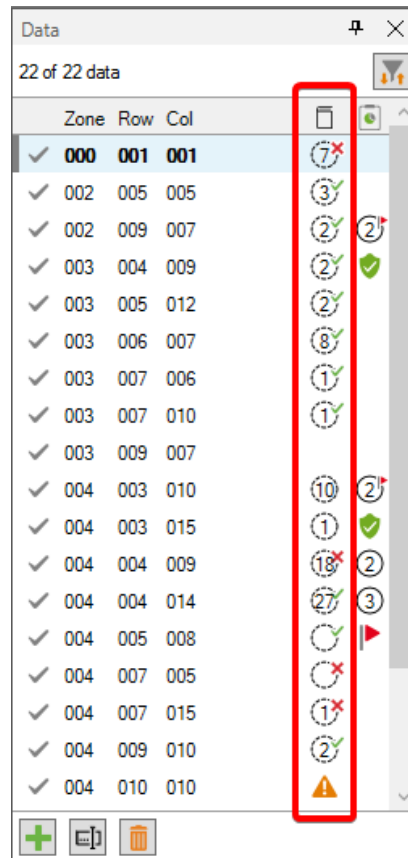

The logbook stores information about the analysis in addition to allowing the following functions: batch screening, seeing results at a glance from the data list pane, and saving manual modifications made to the landmarks during the analysis.

The logbook stores the following information: landmarks (type, position, dimension, including manual modifications), indications (AI and conventional, label, position, dimension, etc.), indication grouping, and data quality validation results. When enabled, an additional column is added to the data file list to allow seeing results and to filter, sort, or analyze according to these results.



The following table shows the possible icons and their meaning:

Icon	Description	Meaning
(empty)	Empty	No logbook entry associated with this file because it has not been screened yet.
	Dashed outline circle, without a number	Logbook entry associated with the file contains information such as landmark detection or regions. The absence of additional information on the icon reveals that no indication detection engine or DQV tests were enabled when the logbook was written.
	Dashed outline circle, with a number	Logbook entries associated with the file contains information such as landmark detection as well as

		detected indications. The number displayed inside the circle shows the quantity of potential indications detected. No DQV tests were enabled when the logbook was written.
	Dashed outline circle, with a green check mark	The green check mark indicates that the DQV test(s) passed on this file.
	Dashed outline circle, with a red cross	The red cross indicates that at least one DQV test(s) failed on this file.
	Dashed outline circle, with a number, with a green check mark	The logbook entries associated with this file indicates that potential indications have been detected by the detection engine and that the DQV test(s) passed.
	Dashed outline circle, with a number, with a red cross	The logbook entries associated with this file suggest that potential indications have been detected by the detection engine and that at least one DQV test(s) failed.
	Orange warning triangle	The AI detection tools identified an unusual situation. In this case, the level of confidence in the detection findings could be very low. Therefore, users should pay special attention when reviewing the detection results.

The logbook is saved within the inspection folder. Its data is written when a file is screened using the dedicated buttons in the Analysis ribbon. It is also automatically written when a file is loaded while the logbook is enabled, and no logbook entry existed for this file yet.

It is worth mentioning that the logbook also includes defects and landmarks, even if these have been detected with detection tools that do not use AI (conventional landmark detection and indication boxes). Also note that the automatic indication detection tools are not available if you use the acquisition license (ACQ).

**LANDMARKS**

The Landmarks button is used to setup the parameters for landmark detection with conventional tools.

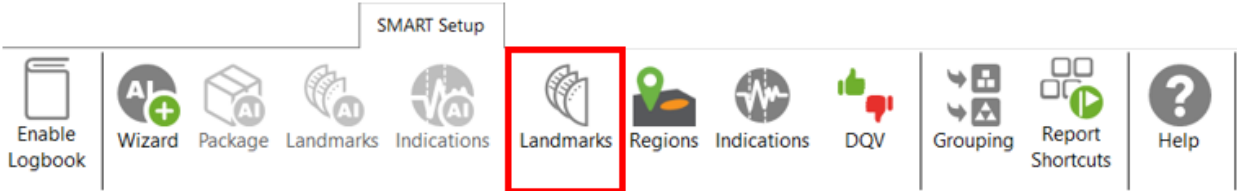

The Landmark Detection window is used to configure the automatic detection of features such as tube sheets and support plates. Landmarks are not mandatory and don't need to be set to have functional setup. They can, however, give a reference for the axial position in a tube. They can also be used by the software to trigger automatic acquisition sequences.

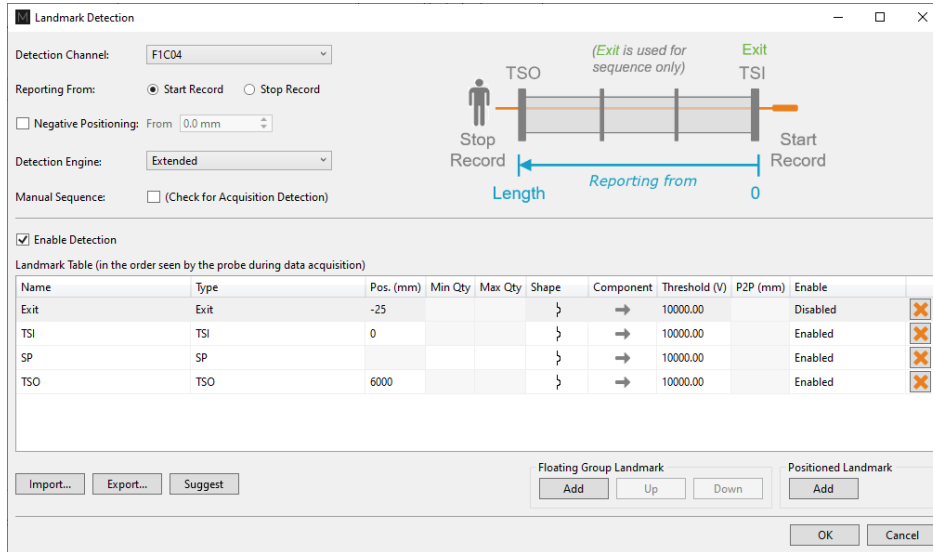

Three landmarks are created if you click on the Suggest button. The channel selected to detect these landmarks should be the lowest frequency absolute channel. The R\_ before the channel stands for Raw. This is the signal of the channel without software filter, rotation, or software gain applied.

You can base the position of your landmarks either on the location where you start to record (usually the tube entrance, opposite from the operator position), or the place where you stop recording (usually the operator side).

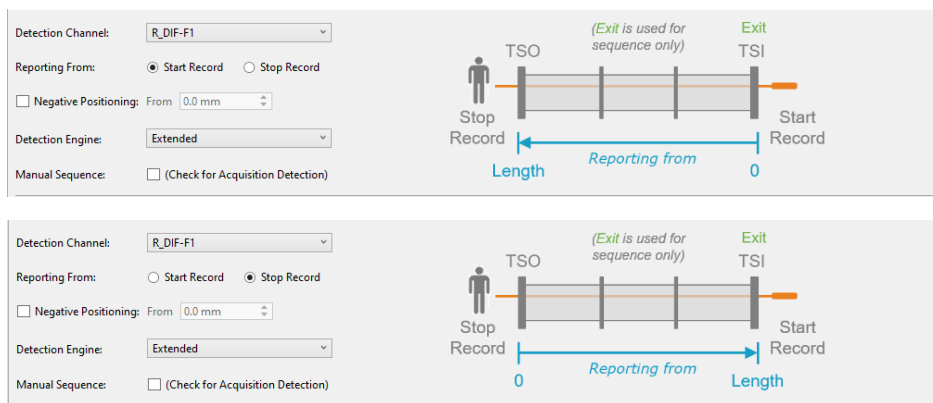

In the above example, the Exit landmark is detected when the probe exits the tube at its outer end. It has a negative position because this event happens before entering the tube. It is enabled only when doing the acquisition.

TSI is the first tube sheet encountered when the probe is pulled. TSO is the last tube sheet encountered at the end of the acquisition.

Landmark detection can be set up manually by describing the shape, component, and voltage threshold that will trigger the detection. The Shape describes the appearance of the signal when the landmark is reached. If a differential signal shape is chosen, the Peak-to-Peak distance (“P2P”) will also be needed. The Direction is the projection axis (horizontal or vertical) of the Lissajous signal that will be taken to trigger the landmark. The Threshold is the voltage amplitude threshold.

Landmarks can be calibrated on real signals; in this case, there is no need to change these parameters as they will be automatically measured by the software. It’s important to set the landmark positions as accurately as possible. If the position is not accurately set, the software might prevent their automatic detection since it won’t be at an expected position.

The Type field is a name that associates the calibration point with the landmark. If landmarks share the same Type, they will be calibrated at the same time using the same point and process. To associate two landmarks with the same Type, their signal must be the same. If support plates of the same geometry are present in a bundle, they can share the same Type. In the above example, TS1 and TS2 don’t share the same Type because one is triggered when the probe goes inside the tube and the other is triggered when the probe exits the tube.

The Detection Engine drop-down menu can be set to Legacy or Extended. With the Legacy mode, all the landmarks need to be entered with the correct position. The system will look for the exact number of landmarks entered at positions close to those entered in the table. With the Extended mode, the system will look for a number of landmarks between the Qty max and the Qty min. With this mode, the exact number of support plates doesn't need to be constant or known.

## REGIONS

The Regions option allows the user to define inclusion/exclusion zones based on Landmarks. This is used to categorize the data to process correctly. For example, they can be useful for restricting the detection of channel saturation to an area within the tube or specify an automatic analysis type for a given region (e.g., under the tube sheets).

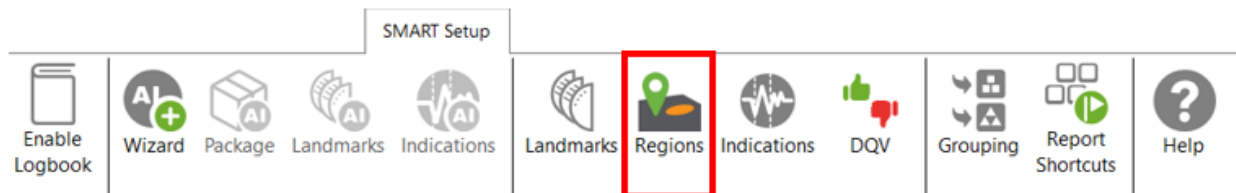

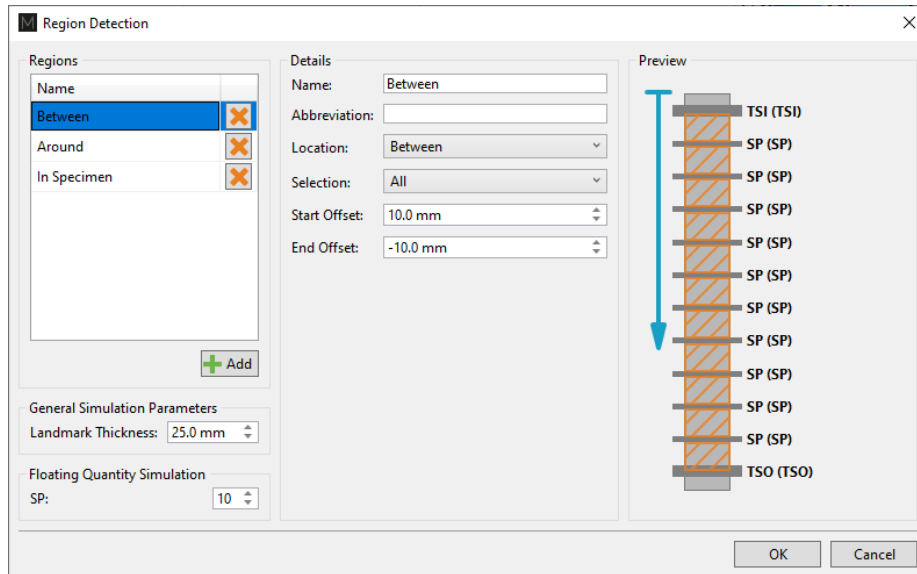

If you are using the conventional detection tools, you can set up the regions according to the automatic analysis tools you will use with the Indications and DQV buttons (described later).

## INDICATIONS



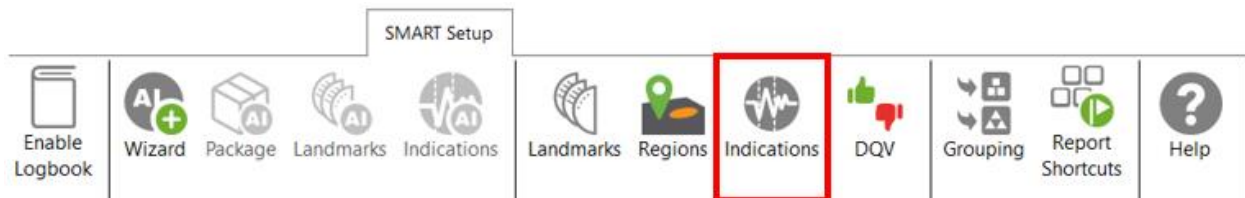

The Indications module allows the user to define various zones or even waveform types to trigger a certain detection threshold.

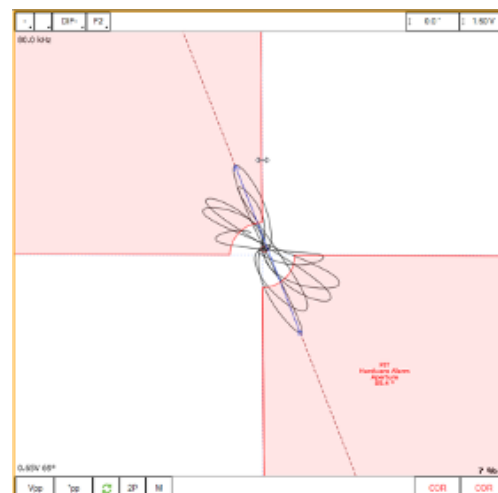
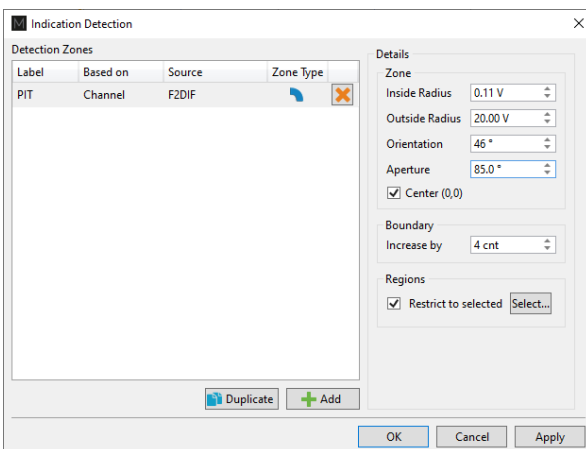







These detection zones can be applied to conventional channels and C-scan channels. The Label is the name that will appear in the Code view.



There are five zone types:

	Absolute pie
	Differential pie
	Centered rectangle
	Rectangle
	Over or under a horizontal or vertical threshold

And seven waveform types:

	Up
	Down
	Down-up
	Any direction
	Up-down
	Down-up-up
	Up-down-up-down

Each zone or waveform can be linked to a defined region, and thresholds can be set. The zone types also include the boundary setting to prevent signal oscillation from triggering unnecessary detections.

Detection zone parameters can also be set by clicking on the Lissajous of the used channel and activating the Edit Alarm option on the Current View tab.

The detected indication can be found in the Indication window, which can be activated in the Layout tab.

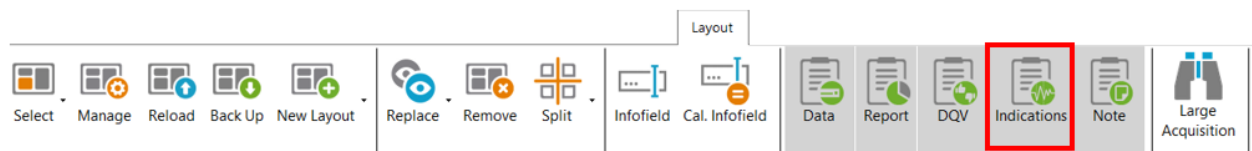

Clicking on an indication in the pane instantly positions the cursor on the selected indication in the Strip chart view. If you click on an indication in the code view (described later), the associated indication is highlighted in the Indications pane.



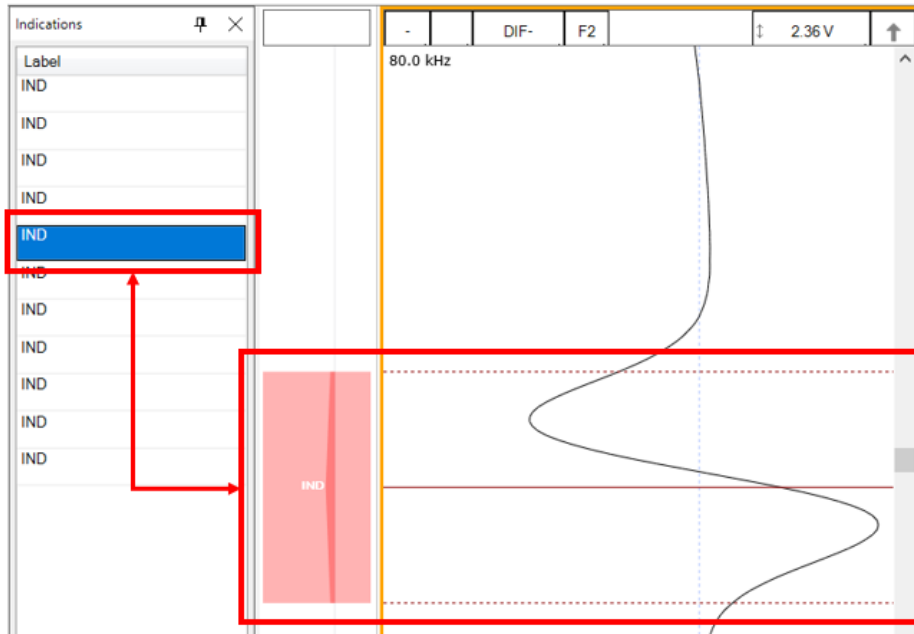

## DATA QUALITY VALIDATION (DQV)

Data Quality Validation allows defining tests to validate the quality of the data.

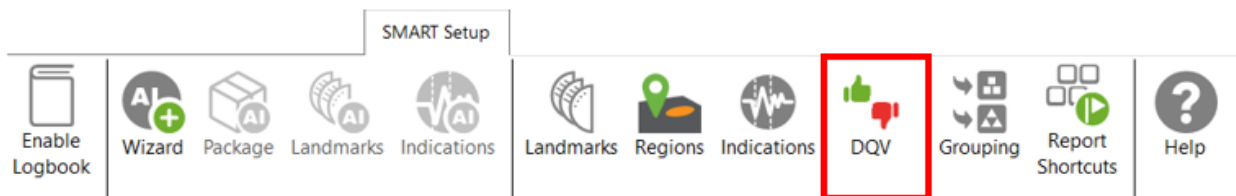

Five test types are available. To add a test, click on the Add button on the DQV page and select the test type with the drop-down menu. Parameters associated with this test can be changed in the Details section of the DQV window.

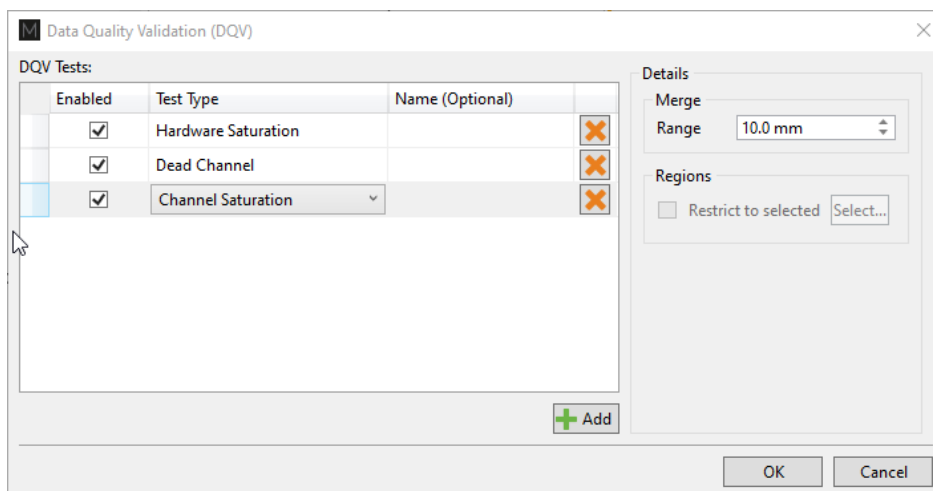

- **Dead Channel:** Verify that channels are reading a signal whose amplitude is above a defined threshold. An amplitude that remains below the threshold throughout the scan indicates a dead channel.
- **Landmark Detected:** Verify the presence of all the selected landmark names in the Details section. To validate full tube-lengths of straight bundles for ECT bobbin data using AI detection, select this option and check the TSI and TSO landmarks. When AI setup for landmarks is completed and the TWH calibrated, the DQV test will automatically use the AI results to perform the test.
- **Hardware Saturation:** Verify if signal saturation appears on raw channels. The merge field allows grouping a zone together in which the test has failed. This function avoids having many notifications if the test fails several times in one area. This test can be limited to a specific region, for example, the areas inside the tube.
- **Channel Saturation:** Verify if signal saturation appears on calibrated channels. The merge field allows grouping a zone together in which the test has failed. This function avoids having many notifications if the test fails several times in one area. This test can be limited to a specific region.
- **C-scan Saturation:** Verify if signal saturation appears on C-scans. The merge field allows grouping a zone together in which the test has failed. This function avoids having many notifications if the test fails several times in one area. This test can be limited to a specific region.

The results of the DQV tests can be found in the DQV window, which can be activated in the Layout tab.

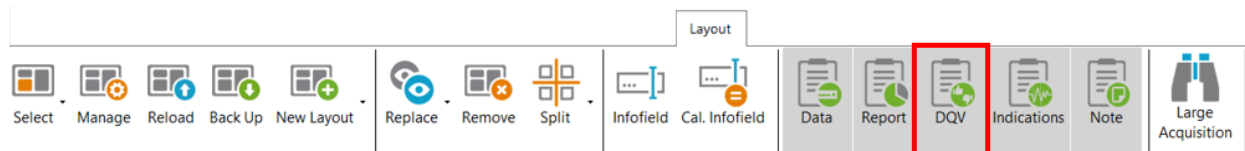

The screenshot shows a window titled 'DQV' with a table of test results and a section for failures.

Test	Result
Channel Saturation	✘ 8 errors
Hardware Saturation	✘ 2 errors

Below the table is a 'Failures' section with a table:

Criteria	
Hardware Saturation	!
Hardware Saturation	!

At the bottom of the window, there are tabs for 'Indications' and 'Note'.

## GROUPING

The grouping tool can help the analyst find critical indications for review as it categorizes and groups the automatically detected indications.

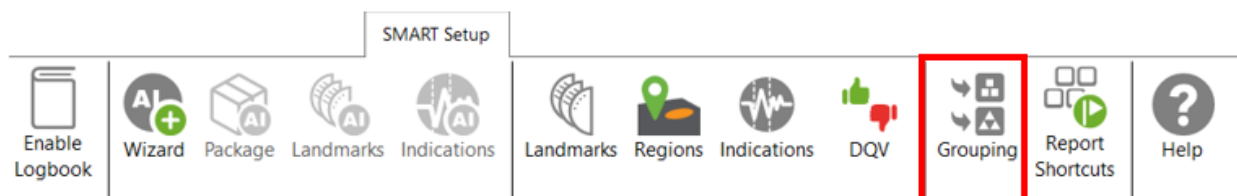

The Grouping menu offers a default configuration with three predefined categories:

- Support Plates
- Critical
- Less Critical

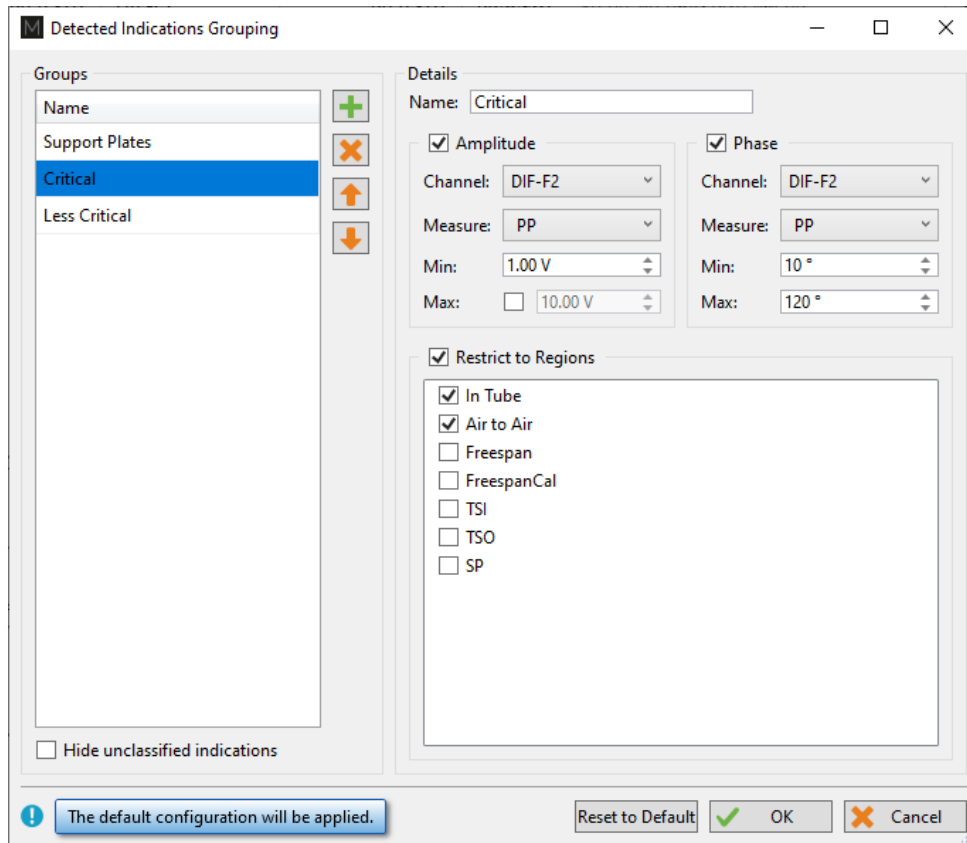

The Details section of each group shows the parameters defining the conditions that must be met for a detected indication to be classified in this group. The user can modify all parameters.

By default, the Support Plates group is configured with the mix channel with a Peak-to-Peak (PP) measurement method, and Max/Min threshold values are set for amplitude and phase. For this group, the criteria are limited to indications detected under the SP regions. As a result, the indications detected under support plates for which all conditions are true will fall into this category.

Critical and Less Critical are two other groups predefined in the Grouping window. Both groups are set on DIF-F2 channel, but with different Amplitude/Phase measurement settings. In both cases, the grouping criteria is restricted to In Tube and Air to Air (for calibration tubes) regions, which covers the full-tube length data.

It should be noted that each automatically detected indication can only be categorized in a single group. Also, the grouping operation is executed according to the order of the groups defined in the Groups list. Therefore, if a given indication meets all the criteria of the first group, it will be categorized in this group. If not, it will be passed to the next group. If it meets all the criteria of the second group, it will be categorized into this one. If not, it will again be passed to the next group, and so on. If an indication does not meet the criteria of any group, it will be placed in the Unclassified group. This implies that every single indication will be categorized, and none can appear simultaneously in more than one group.

New groups can be created with custom parameters.

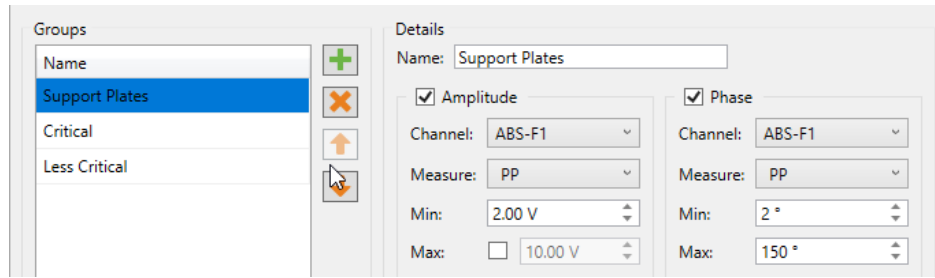

It is also possible to remove a group or use the up/down arrow keys to change the group priority within the list.

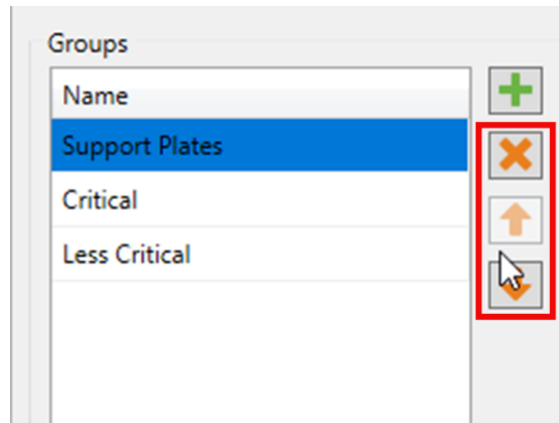

In the Front stage interface, the Grouping results will be displayed in the Indications pane.

Indications 10 of 10 results

Label	Ampl.	Phase
⤴ Critical (4)		
IND	14.15 V	82 °
IND	3.40 V	83 °
IND	2.78 V	106 °
IND	7.06 V	16 °
⤴ Less Critical (4)		
IND	1.02 V	111 °
IND	1.00 V	40 °
IND	1.27 V	56 °
IND	1.13 V	73 °
⤴ Unclassified (2)		
IND		
IND		

DQV Indications Note

To help the analyst focus on the most relevant detected indications furthermore, it is possible to hide the Unclassified indications. To accomplish this, check the box “Hide unclassified indications” at the bottom of the Grouping menu and click on OK.

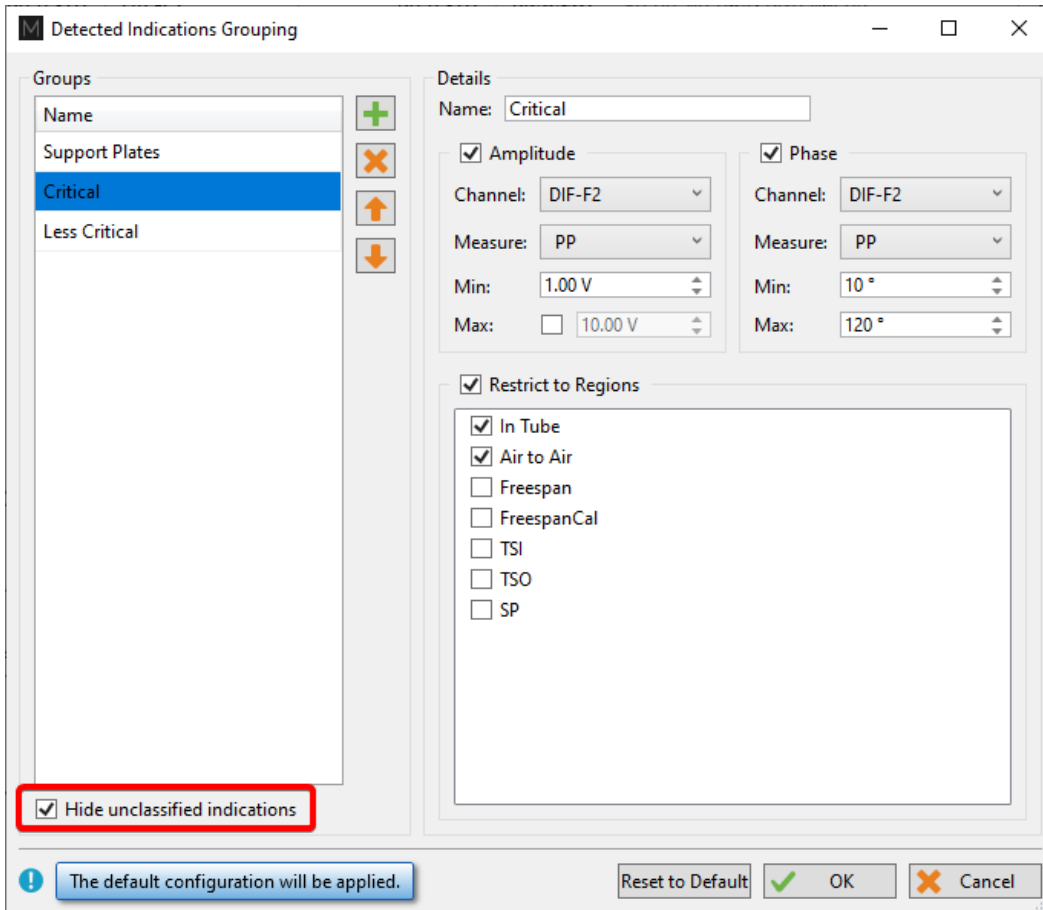

Enabling this option influences the following elements of the software:

- Indications pane;
- Code view;
- Logbook column.

The images below compare them when the Unclassified indications are shown (left) and when they are hidden (right).

When the option is enabled, the Indications pane will not show the “Unclassified” group. The count in the header serves as a reminder to the user that not all indications are currently shown.

Indications 26 of 26 results

Label	Ampl.	Phase
<b>^ Critical (1)</b>		
IND	1.53 V	17 °
<b>^ Less Critical (5)</b>		
IND	1.00 V	14 °
IND	0.93 V	10 °
IND	0.84 V	18 °
IND	0.76 V	17 °
IND	1.20 V	19 °
<b>^ Unclassified (20)</b>		
IND		
IND		
IND		
IND		
IND		

DQV Indications Note

Indications 6 of 26 results

Label	Ampl.	Phase
<b>^ Critical (1)</b>		
IND	1.53 V	17 °
<b>^ Less Critical (5)</b>		
IND	1.00 V	14 °
IND	0.93 V	10 °
IND	0.84 V	18 °
IND	0.76 V	17 °
IND	1.20 V	19 °

DQV Indications Note

In the Code view, the red markers from the Unclassified indications have been removed.

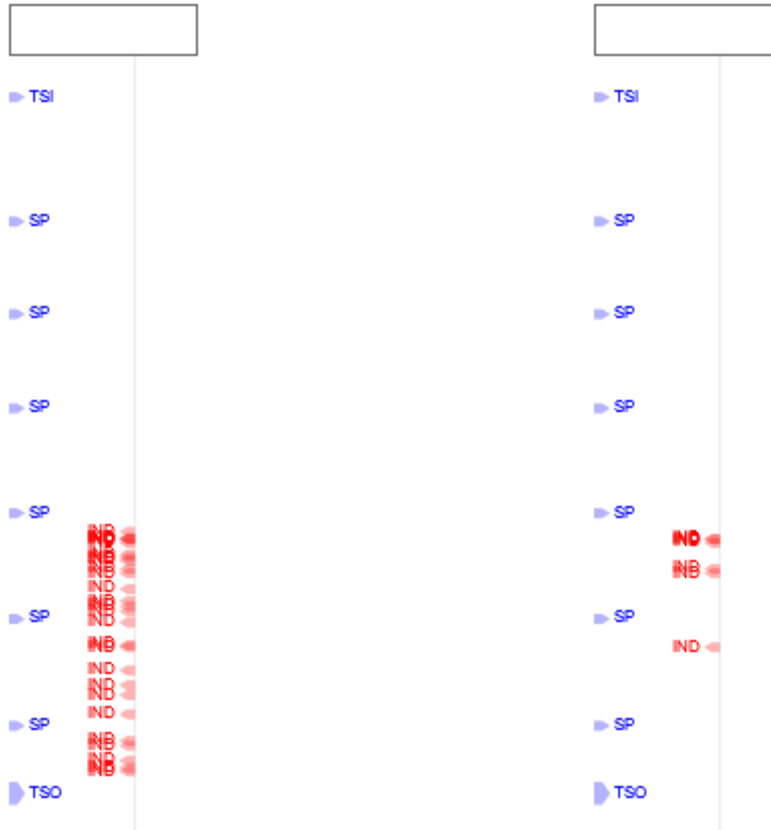

In the data file list, the number shown in the Logbook column represents the number of visible indications, matching the number shown in the header of the Indications pane.

Data		↑	×
7 of 7 data		⏏	
Row	Col		
✓	201000001		
✓	201004005		
✓	<b>201006009</b>	(26)	
✓	201006016		
✓	201024022		
✓	201025017		
✓	201025019		

Data		↑	×
7 of 7 data		⏏	
Row	Col		
✓	201000001		
✓	201004005		
✓	<b>201006009</b>	(6)	
✓	201006016		
✓	201024022		
✓	201025017		
✓	201025019		



## REPORT SHORTCUTS

Keyboard shortcuts can be used to make entries in the report. By opening the shortcut window, it is possible to select a channel with a measurement method and to associate an indication with it.

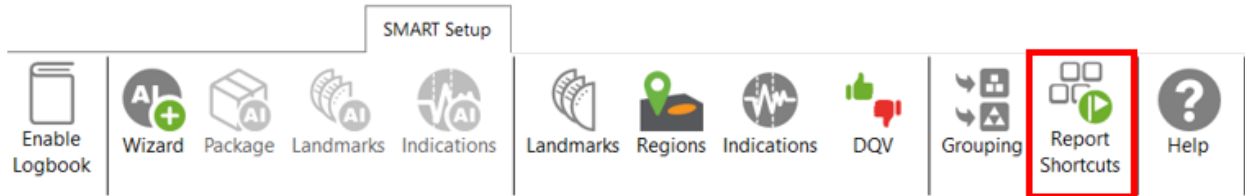

For example, we could use the differential channel F2 with a Peak-to-Peak measurement method to enter pits in the report.

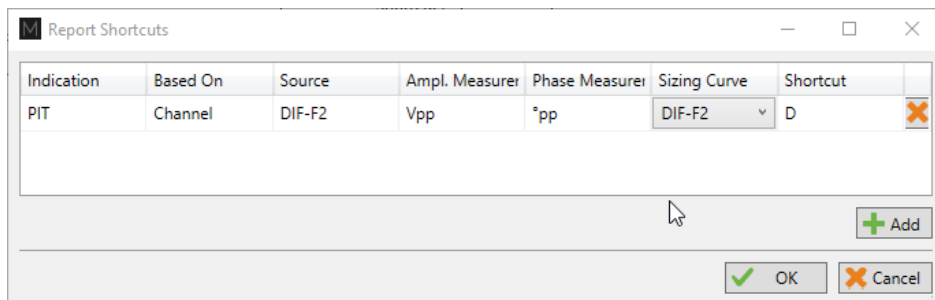

To select a key, press the Shortcut field and press the desired key on your keyboard. It is possible to use a single key or a combination of keys such as ALT+D, for example.

When a report entry is made with the keyboard shortcut, the abbreviation of the type of indication displays momentarily on the corresponding Lissajous.

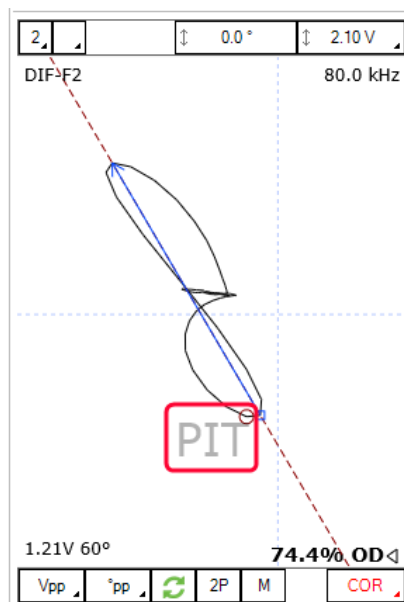

## DATA SCREENING

Data screening set up with the SMART Setup tools can be performed by the two buttons on the left under the Analysis tab.



It is possible to run analysis on a selection of files or all files. The analysis is typically performed on all files when the setup and calibration are adequate. The results are recorded in the logbook and can be viewed in the Data window.

## LIMITATIONS

Some operations, processes, and options are not available for the RFA probe and configuration in Magnifi. This section lists the limitations of the workflow in Magnifi.

- RFA setups can only have two frequencies. More frequencies cannot be added.
- The Absolute C-scan does not have a Voltage plane representation, only a Lissajous representation.
- Contrary to conventional RFT setups, it is not possible to link the Absolute and Differential conventional channels together with RFA setups when the Voltage plane representation is used.
- The RFA Wizard cannot generate encoder-based setups.
- If the Periodic Noise filter has been activated, it may take a few seconds to complete processing. This is normal - the process can take up to more than a minute for very long scans.
- The setup wizard does not suggest excitation frequencies based on the tube characteristics. This parameter must be determined by the user.

## APPENDIX 1 – VOLTAGE PLANE

---

The following two equations describe the through-wall transmission behavior of RFT:

The phase lag equation shows that the signal is not only influenced by the tube properties, but also

$$B = B_0 e^{-\phi} = B_0 e^{-d \sqrt{\pi f \sigma \mu_0 \mu_r}} \qquad \phi = d \sqrt{\pi f \sigma \mu_0 \mu_r}$$

depends on the frequency ( $f$ ) at which the tube is inspected. Given a tube of constant permeability and

$B$	=	Magnetic field strength at a depth corresponding to phase lag ( $\phi$ )	$\phi$	=	Phase lag
$B_0$	=	Initial magnetic field strength	$\mu$	=	$\mu_0 \mu_r$ = Permeability
$\phi$	=	Phase lag	$d$	=	Thickness
			$f$	=	Frequency
			$\sigma$	=	Conductivity

conductivity, and using a fixed inspection frequency, the phase lag will be proportional to the thickness of the tube.

The magnetic field strength ( $B$ ) will depend on this phase lag. For an infinite theoretical thickness, the resulting magnetic field will be null. The explanation being that the field is completely blocked and that nothing is caught by the receiver(s).

The voltage plane is a graphical representation of these formulas. The curves built on a voltage plane show the effect of the thickness variation on the signal. There are four curves that represent a flaw coverage of 90°, 180°, 270° and 360°. The point crossing the horizontal axis is the nominal point. This is the signal obtained when the probe is in a sound area of the tube. It has an amplitude of 1V and a phase of 0°.

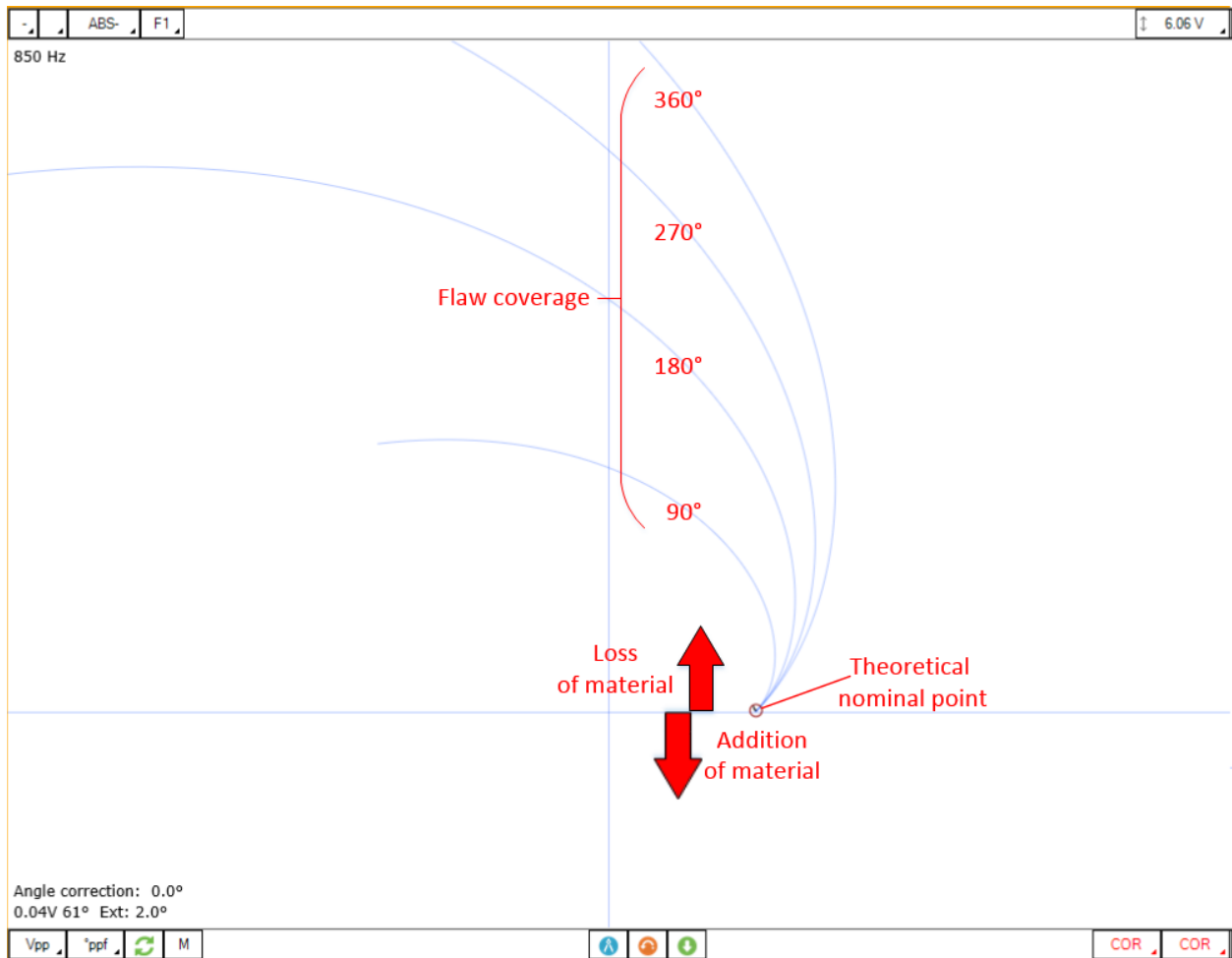

When you first scan your calibration tube, this point doesn't match the nominal point of your theoretical curve. You must calibrate the signal to match your probe signal to the theoretical curve(s). This operation is called normalization.

A bundle of tube may include tubes that have different properties. The permeability, for example, may be different for some tubes. This will affect the nominal point position and the built sizing curves won't be applicable to this tube.

If the nominal point has not moved too far from the theoretical nominal point, the common practice is to renormalize and to size the flaw with the built sizing curves.

If the nominal point has moved far from the theoretical value, it means that the tube properties are significantly different from the calibration tube. Therefore, the phase lag for a given flaw will also be significantly different and this will generate an error in the sizing that must be considered. In this case, it is recommended to change the drive frequency to put the nominal point back to the renormalization zone.

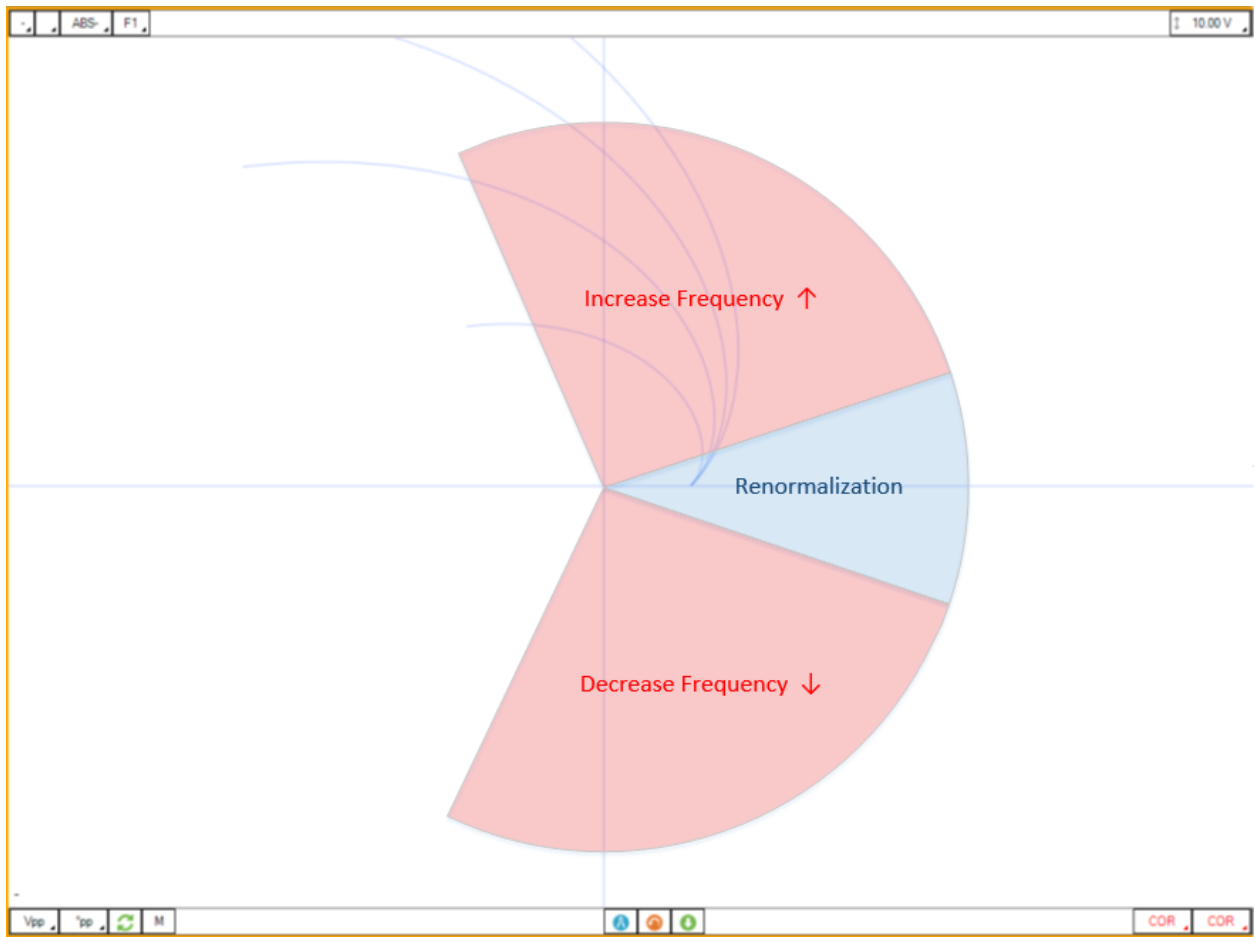

A common practice is to set the threshold angle at which the inspection frequency needs to be changed to 30°.

## APPENDIX 2 – PERIODIC NOISE FILTER

---

The *Periodic noise filter* addresses the presence of cyclic or periodic noise in C-scans caused by the tube manufacturing process.

The pilger process in tubing manufacturing may create a cyclic permeability change along the length of tubes. This in turn may cause noise that appears like visible diagonal stripes in C-scans. In most cases, this noise is low and will not prevent the analysis of the C-scan signal but in the instances where the noise is stronger, the *Periodic noise filter* may help to reduce it.

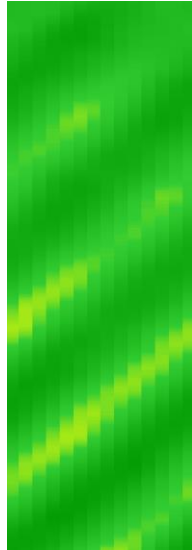

Pilger noise

By default, the filter is not enabled. All filters affect the signal to which they are applied to a greater or lesser extent, and improper use can lead to the creation of artifacts or can negatively affect the signal. It is recommended to use this filter only on data that has pilger noise that interferes with the analysis.

It is possible to enable the filter and to set most parameters within the “C-scans” step of the RFA setup wizard.

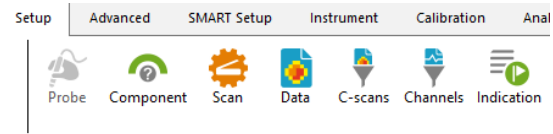

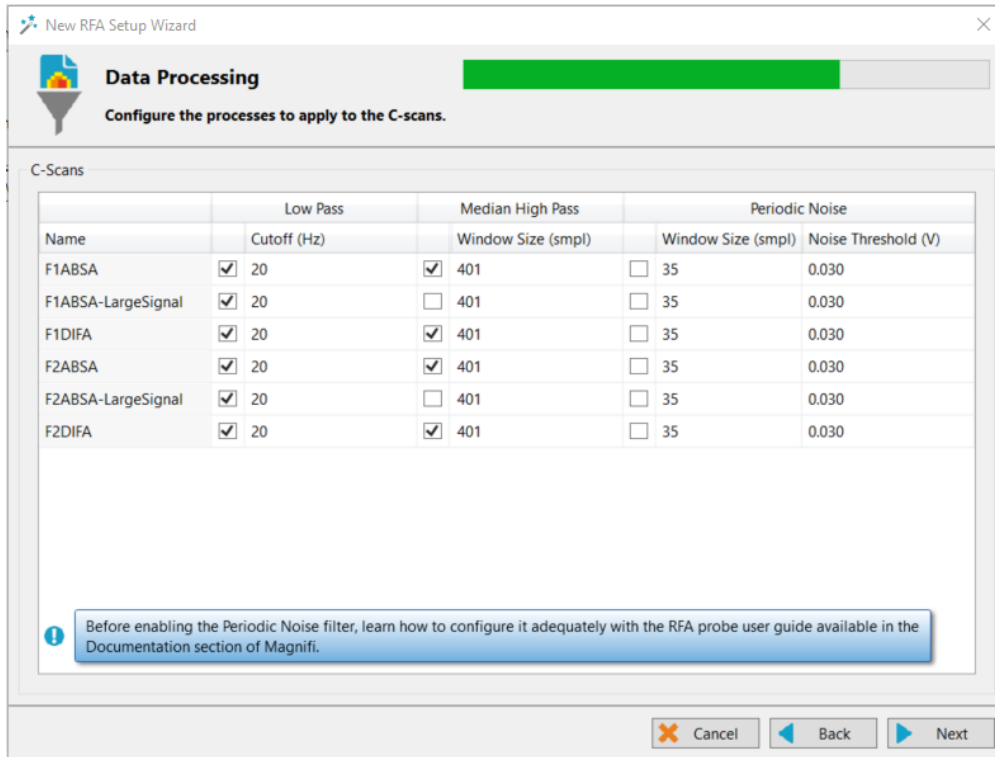

Checking the box on the desired C-scan line under the *Periodic Noise* column enables the filter. The other parameters are described below.

It is also possible to enable the filter and access the filter parameters by right-clicking on the desired C-scan and selecting the C-scan configuration menu. Double-clicking on *Periodic Noise Filter* brings up the *Periodic Noise Filter Configuration*.

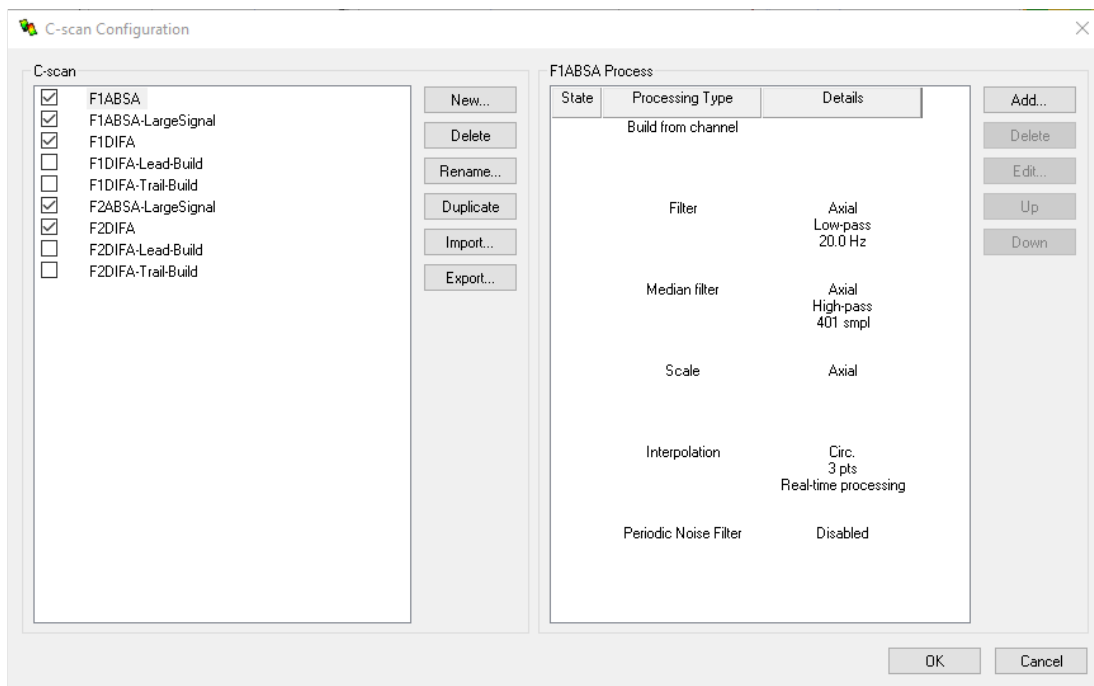

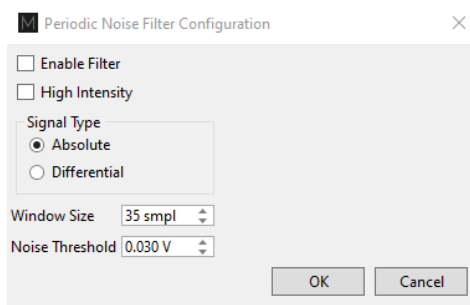

The "**Enable filter**" option allows you to activate or deactivate the filter.

The correct **signal type**, either "*absolute*" or "*differential*", must be selected according to the type of C-scan to which it is applied.

The **Window Size** is the axial direction zone size, in data samples, that is considered by the filter. The size of the window can be determined by measuring the axial length of a small defect, in samples, such as the through-hole in the calibration tube. For RFA probes, this value is then divided by 5 for absolute C-scans, and by 8 for differential C-scans.

$$\text{Window Size}_{\text{Absolute}} = \frac{\text{Target defect size in samples}}{5}$$

$$\text{Window Size}_{\text{Differential}} = \frac{\text{Target defect size in samples}}{8}$$

To measure the axial length of a defect, place the beginning and the end of the cursor at the defect's axial extremities and read the value displayed in the  $\Delta Y$  (smpl) field.

In the example below, on an absolute C-scan, the complete target defect signal is 185 samples long. Therefore, a *Window Size* value of  $185/5 = 37$  samples could be used.

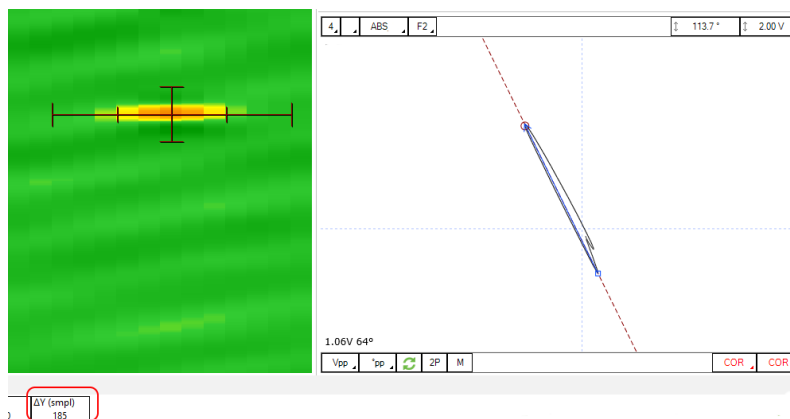

The **Noise Threshold** parameter allows the filter to process only noise that comes from a periodic source that needs to be reduced. Therefore, this threshold is set at an amplitude, in volts, between the observed



periodic noise level and other baseline noise. The absolute peak measurement method can be used to read the noise level.

Baseline noise can be measured when the probe is stationary in the calibration tube in an area free of defects. The signal coming from the pilger noise can be measured in a fault-free zone.

If, for instance, the periodic noise has an approximate amplitude of 0.100 V and the baseline noise is about 0.020 V, the *Noise Threshold* must be set between these two values.

The **High Intensity** checkbox does a more intense version of the filter. In the case of very high periodic noise, it will reduce the noise further, but may create signal discontinuities.

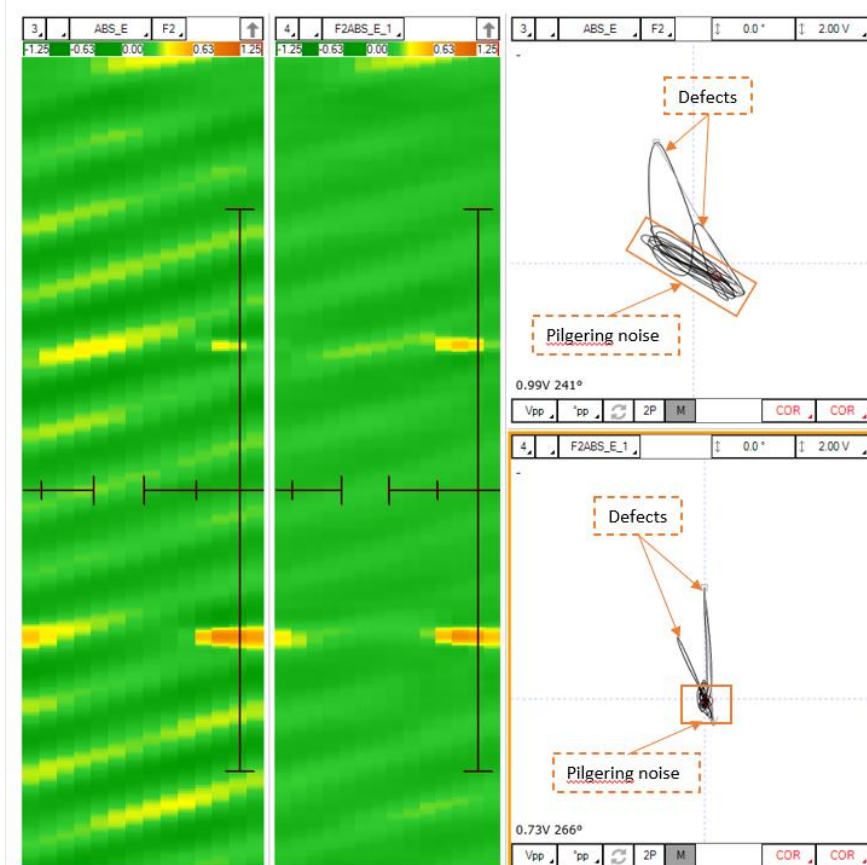

The example above (left) shows a relatively high noise level. On the right, the result after applying the filter is shown. On the unfiltered C-scan impedance plane (top), the cyclic noise (seen as overlapping ovals at the base of the defects) affects the signal to noise ratio and enlarges the defects such that the phase is difficult to measure. On the filtered C-scan impedance plane (bottom), the signal is cleaner, and the phases are easy to measure since the signals are narrow.

The Periodic Noise Filter does several operations in a row, and certain design constraints must be highlighted to understand how it behaves:

- As previously mentioned, low noise levels usually do not necessitate filtering. It might prove difficult to set a Noise threshold that would be consistently below the periodic noise and above other noises. If this value is not set correctly or the periodic noise is too low, the filter will not work correctly.
- The filter must be used on signals that are around the zero mark (nulled / high-pass median-filtered signals).
- The filter uses parts of the signal that only include pilger noise to determine its parameters. If there are very large defects in a zone, the software might not be able to find an adequate pilger noise signal and it will not be correctly filtered.
- Similarly, filtering might be inefficient at the beginning and end of the scan because there is not enough data to measure the pilger noise parameters.
- In the C-scan configuration window (seen above), each filter in the list sequentially processes the data
- The filter receives the signals obtained from the processes that precede it (see the C-Scan configuration window above). This means that any signal amplitude used to select a *Noise Threshold* must be measured on the signal that the filter receives. Since the periodic noise filter is last in the C-scan processing chain, measure the signal with the filter disabled to determine the correct value.
- Prior processes like median filters or other filters might in some circumstances generate artifacts (straight lines, data at zero) that will in turn affect the periodic noise filtering (seen below).
- This filter is computationally intensive, so the processing time for long files can be a minute or more for a single file.

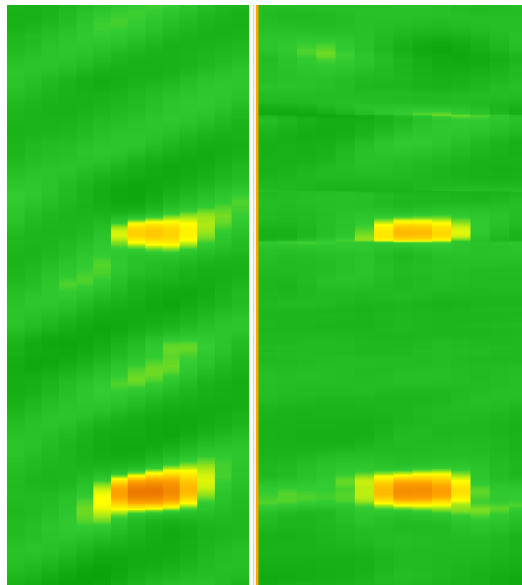

# NFT Application Guide

## NFT Bobbin Probes

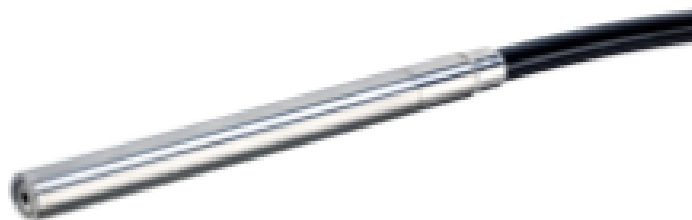

## INTRODUCTION

This document presents how to use an NFT probe with Magnifi on an Ectane test instrument.

## EQUIPMENT

NFT probes use a 19-pin connector that can be connected to an Ectane with the “ERNM” option. The absolute and differential signal from the probe will provide Strip charts and Lissajous.

As these probes need to fill an optimal portion of the tube inner diameter, a wide range of probe diameters are offered (see the tubing probe catalog for more details).

From the following table, the best standard probe for your application can be selected. Note that Eddyfi also offers custom products that are not shown in these tables.

Table 11 – NFT-BBAD probes diameter selection table

TUBE OD		TUBE WT			DIAMETER			FREQUENCY		POLY		PROBE PART NUMBER
mm	In	BWG	mm	In	CODE	mm	In	CODE	RANGE	CODE	LENGTH	
19.05	0.750	10	3.40	0.134	110	11	0.433	MF	50–2000Hz	20	20 m (66 ft)	PRBT-NFT-BBAD-110MF-Nzz
		11	3.05	0.120	120	12	0.472					PRBT-NFT-BBAD-120MF-Nzz
		12	2.77	0.109	130	13	0.512					PRBT-NFT-BBAD-130MF-Nzz
		13	2.41	0.095								
		14	2.11	0.083	140	14	0.551					PRBT-NFT-BBAD-140MF-Nzz
		15	1.83	0.072								
		16	1.65	0.065								
		17	1.47	0.058								
25.40	1.000	18	1.24	0.049	150	15	0.591					PRBT-NFT-BBAD-150MF-Nzz
		9	3.76	0.148	160	16	0.630					PRBT-NFT-BBAD-160MF-Nzz
		10	3.40	0.134	170	17	0.669					PRBT-NFT-BBAD-170MF-Nzz
		11	3.05	0.120	180	18	0.709					PRBT-NFT-BBAD-180MF-Nzz
		12	2.77	0.109								
		13	2.41	0.095	190	19	0.748					PRBT-NFT-BBAD-190MF-Nzz
		14	2.11	0.083								
		15	1.83	0.072								
		16	1.65	0.065								
		17	1.47	0.058	200	20	0.787					PRBT-NFT-BBAD-200MF-Nzz
18	1.24	0.049	210	21	0.827	PRBT-NFT-BBAD-210MF-Nzz						

31.75	1.250	8	4.19	0.165	210	21	0.827	MF	50–2000Hz	20	20 m (65 ft)	PRBT-NFT-BBAD-210MF-Nzz
		9	3.76	0.148	220	22	0.866					PRBT-NFT-BBAD-220MF-Nzz
		10	3.40	0.134	230	23	0.906					PRBT-NFT-BBAD-230MF-Nzz
		11	3.05	0.120								PRBT-NFT-BBAD-240MF-Nzz
		12	2.77	0.109	240	24	0.945					PRBT-NFT-BBAD-250MF-Nzz
		13	2.41	0.095								PRBT-NFT-BBAD-260MF-Nzz
		14	2.11	0.083								PRBT-NFT-BBAD-270MF-Nzz
		15	1.83	0.072	250	25	0.984					PRBT-NFT-BBAD-280MF-Nzz
		16	1.65	0.065								PRBT-NFT-BBAD-290MF-Nzz
		17	1.47	0.058	260	26	1.024					PRBT-NFT-BBAD-300MF-Nzz
18	1.24	0.049	PRBT-NFT-BBAD-310MF-Nzz									
38.10	1.500	8	4.19	0.165	270	27	1.063					PRBT-NFT-BBAD-270MF-Nzz
		9	3.76	0.148	280	28	1.102					PRBT-NFT-BBAD-280MF-Nzz
		10	3.40	0.134	290	29	1.142					PRBT-NFT-BBAD-290MF-Nzz
		11	3.05	0.120	300	30	1.181					PRBT-NFT-BBAD-300MF-Nzz
		12	2.77	0.109								PRBT-NFT-BBAD-310MF-Nzz
		13	2.41	0.095	310	31	1.220					
		14	2.11	0.083								
15	1.83	0.072										

The NFT calibration tube used in this document includes the following flaws:

- Internal groove, 30% of wall loss
- Internal round bottom holes (RBH), 6.35mm diameter, 75% of wall loss
- Through wall hole, 6.35mm diameter
- Internal round bottom holes (RBH), 6.35mm diameter, 50% of wall loss
- Internal round bottom holes (RBH), 6.35mm diameter, 25% of wall loss
- Internal groove, 60% of wall loss

Other combinations of flaws can be used to calibrate the probe and to build sizing curves.

## PROJECT AND INSPECTION FILES

---

In this section, we will create a folder structure that will manage the saving location of your setup, data and report. This management is operated through the creation of a *Project*.

Magnifi suggests two levels of file. The first level is the *Project*. It is meant to include different inspections that are related in some way. For instance, it can include all the inspections done at a refinery shutdown and be named *Refinery\_Shutdown\_May\_2018*. The second level of the file is the *Inspection* folder. Inspection folders are saved in the project file. An inspection folder can include data specific to the inspection of a tube bundle with a specific technology and could be named *CS\_075x0.065\_NFT* for instance. This inspection folder groups the setup, the tube list, the data files and the Magnifi report.

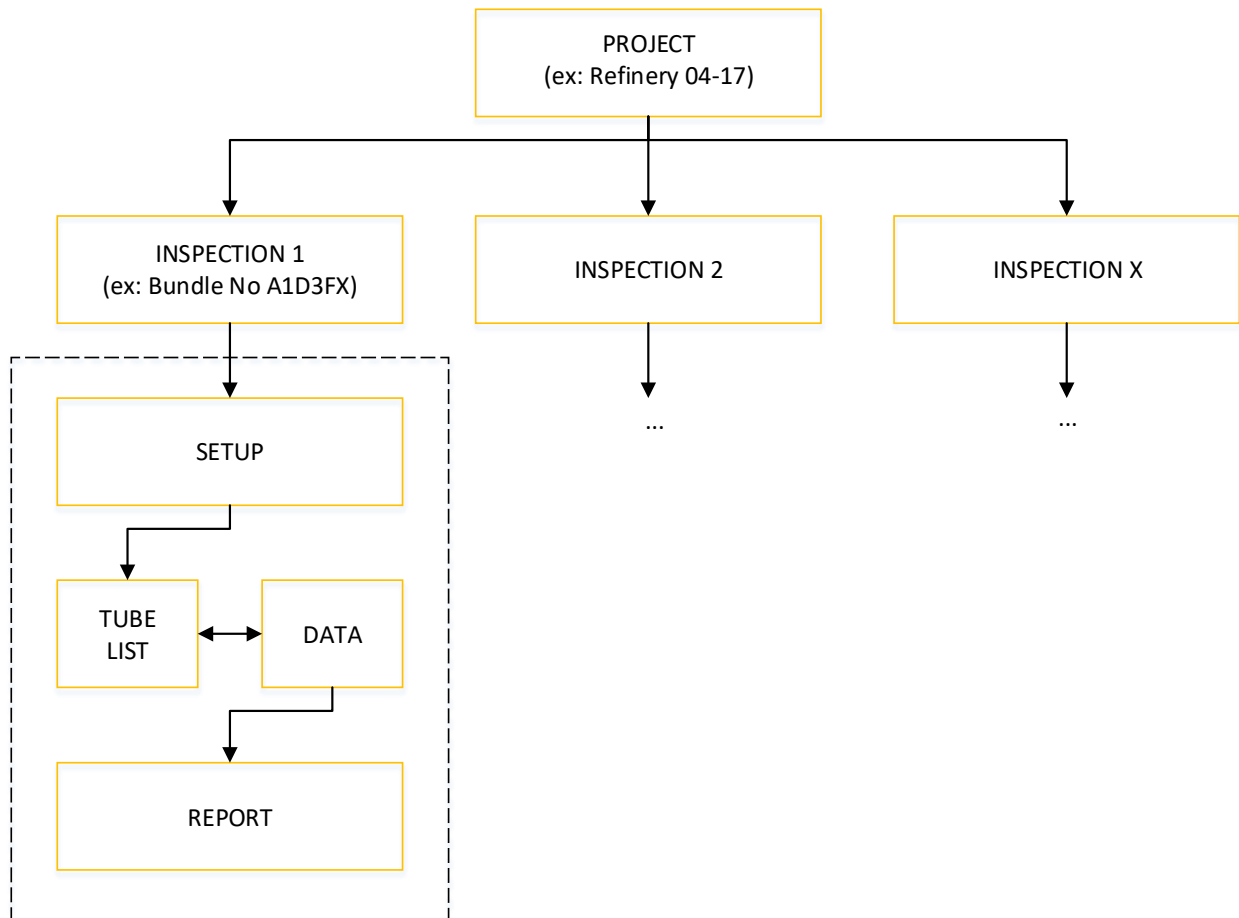

When you open Magnifi, the first page displayed is called the *Backstage*.

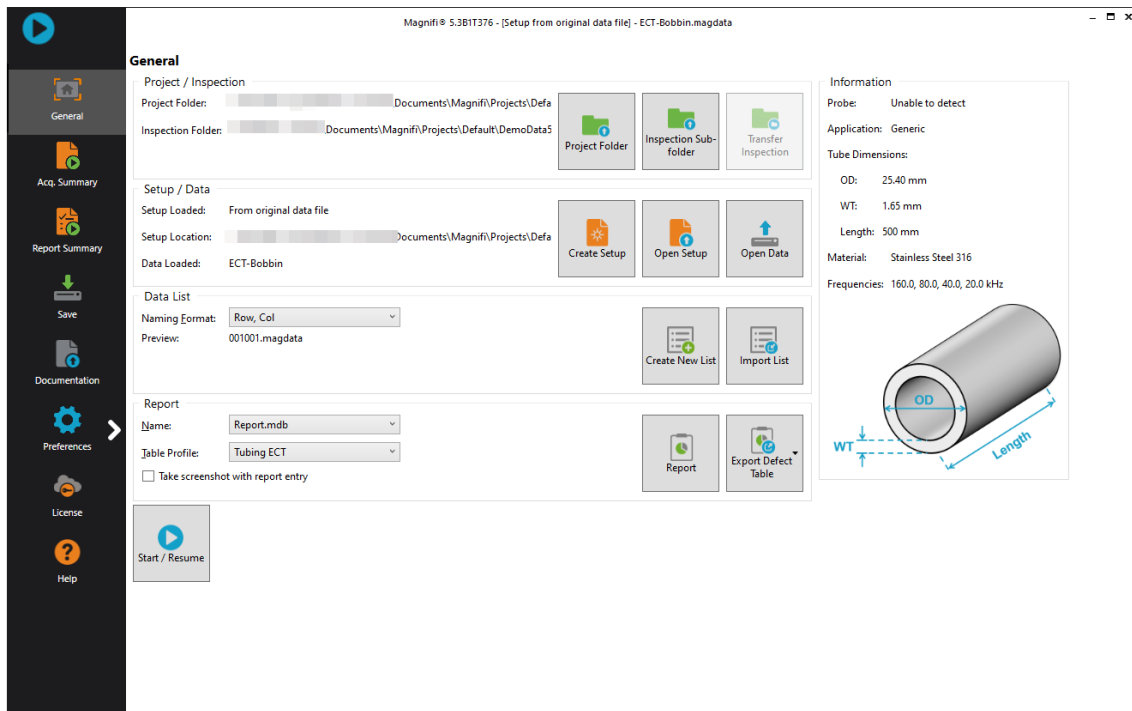

To create or open a project, click on *Open/Add Project* in the backstage. You can select an existing project/folder or you can create a new folder.

1. Create a folder by right-clicking on the location where you want to add your project file. Select *New, Folder* and enter the chosen name. You can then select the newly created folder and click on *Select Folder*.

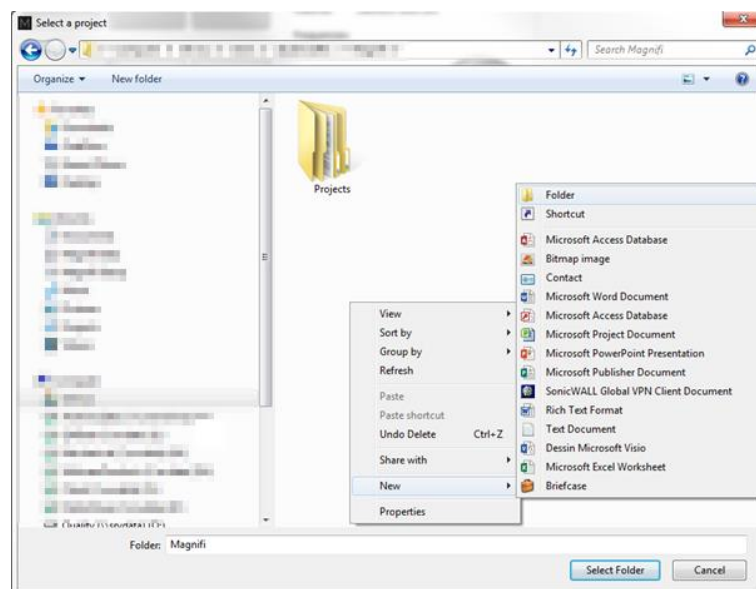



2. Click on *Add/Open Inspection* in the backstage, then click on *Add* and enter the name of your inspection.

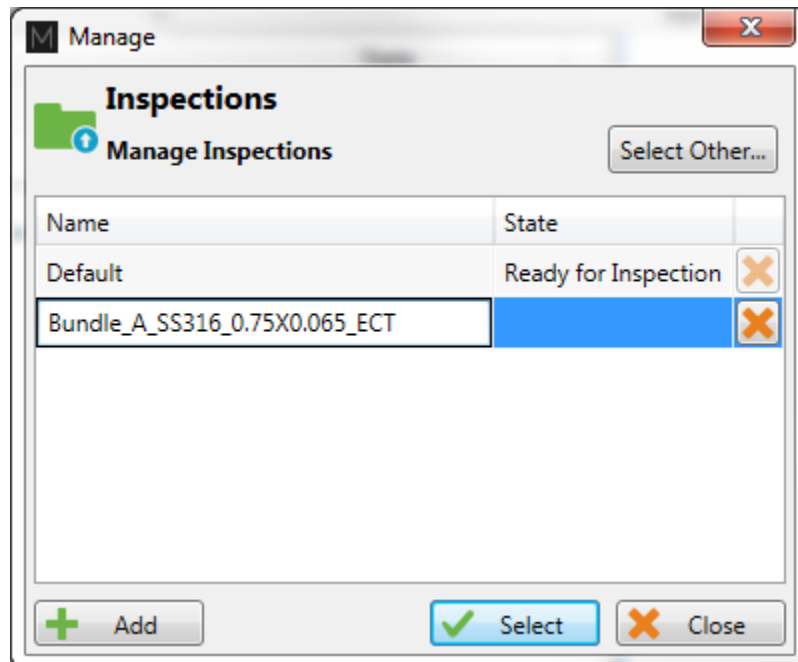

3. Click *Select*. This will define the position where the setup(s) and data will be saved.

## SETUP WIZARD

In this section, we will show how to create a setup using the *Setup Wizard* in Magnifi.

Before going further, you can change the measurement unit. To do so, click on *Preferences*. In the *System* tab, you can change the measurement units from metric to imperial and vice versa. For the metric units, you can choose to use meters, centimeters, or millimeters in the *General* tab. The default measurement for imperial units is inches. When finished, click on *Preferences* again to go back to the *General* window.

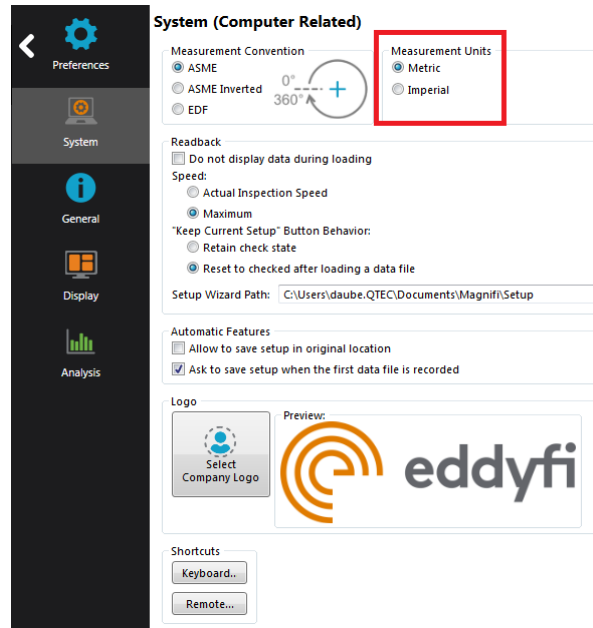

To create a new setup, it's strongly suggested to use the *Setup Wizard* process. Click on *Create Setup* to start the *Setup Wizard*.

## COMPONENT DEFINITION

The first page shown by the Setup Wizard is the Component Definition.

Click on the Material field to open the drop-down menu. Select the material of the tube to be inspected. If the material is not in the list, you can click on Manage... to open the List of Available Material window.

**New Setup Wizard** ×

**Component Definition** █

Configure the geometry and material of the component to inspect

**Geometry:**  Surface  Tube from ID

**Application:**  Generic  Air Conditioner

**Material:** Carbon steel Manage...

Resistivity: 21  $\mu\Omega\cdot\text{cm}$   
Permeability: 450  $\mu$   
Velocity: 5890.000 m/s

**Wall thickness:** 1.65 mm

6 16 24 BWG

**Outside diameter:** 19.05 mm

**Length:** 6000 mm

**Note about selected material:**  
ASTM: A178, A179, A192, A210, A214

✗ Cancel ◀ Back ▶ Next

To add a new material to the list, click on *Add*. A new line will appear in the list. Give the material a relevant name and set the material resistivity and permeability to its theoretical value. The ultrasound velocity is used to set IRIS parameters only, and it doesn't need to be set if an IRIS inspection is not performed on this material.

It's possible to add a note about the material to specify information such as its application or composition. When you are done, click *OK*.

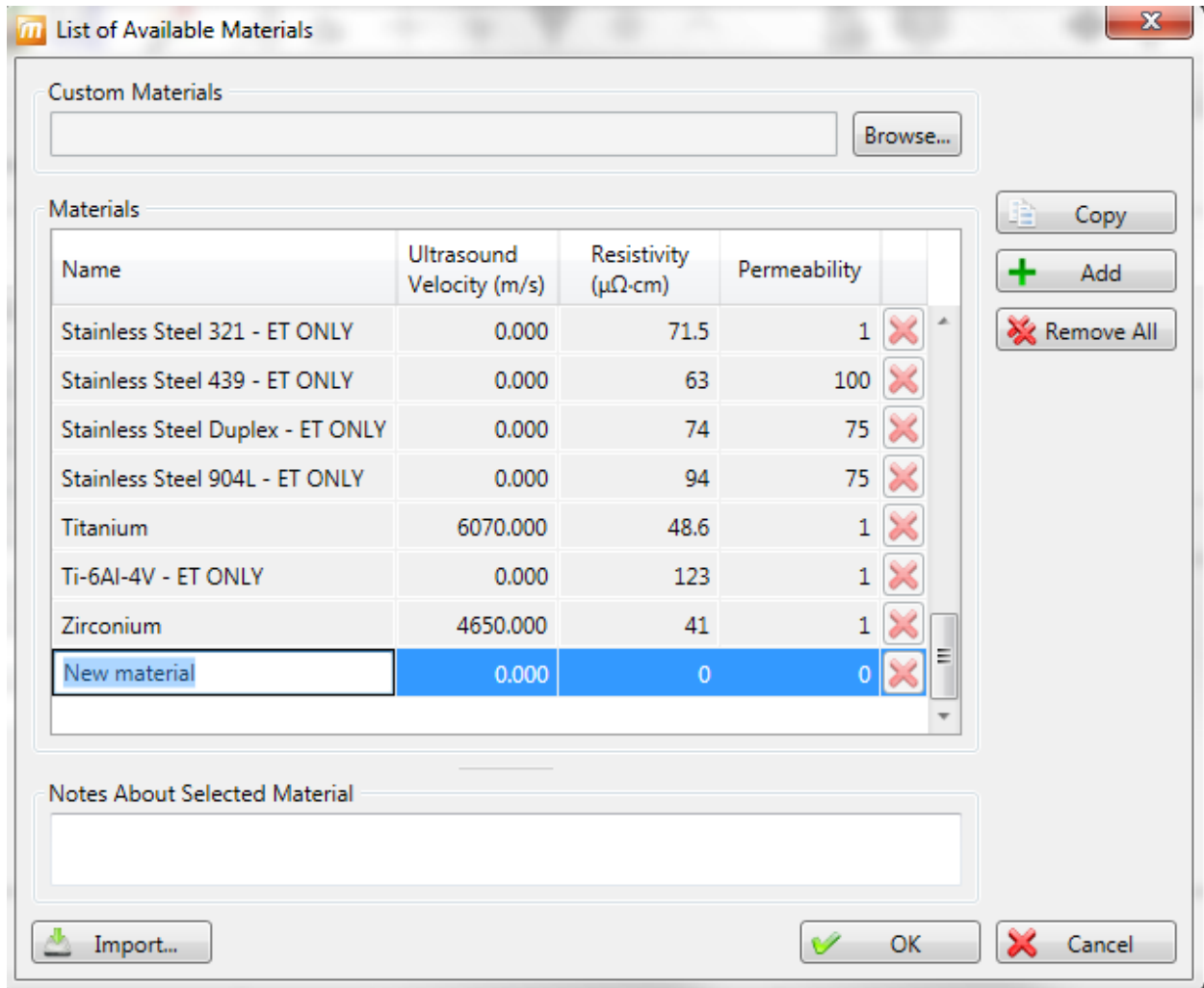

You will be back to the *Component Definition* window. If you add new material, it will be available in the material list.

Adjust the tube wall thickness by entering the value in the *Wall thickness* field or by moving the slider. Enter the tube's outer diameter and length.

These tube properties will help Magnify to suggest the optimal scan parameters.

Click *Next* when everything is set correctly.

## PROBE SELECTION

In the *Probe Selection* window, select the probe you will be using for your inspection.

You can filter the probe list by choosing an inspection technique from the *Technique* drop-down menu. More precise filtering can be done by using the *Model* drop-down menu. You can then select your probe by its catalog number (PRBT-NFT-BBAD) and then click *Next*.

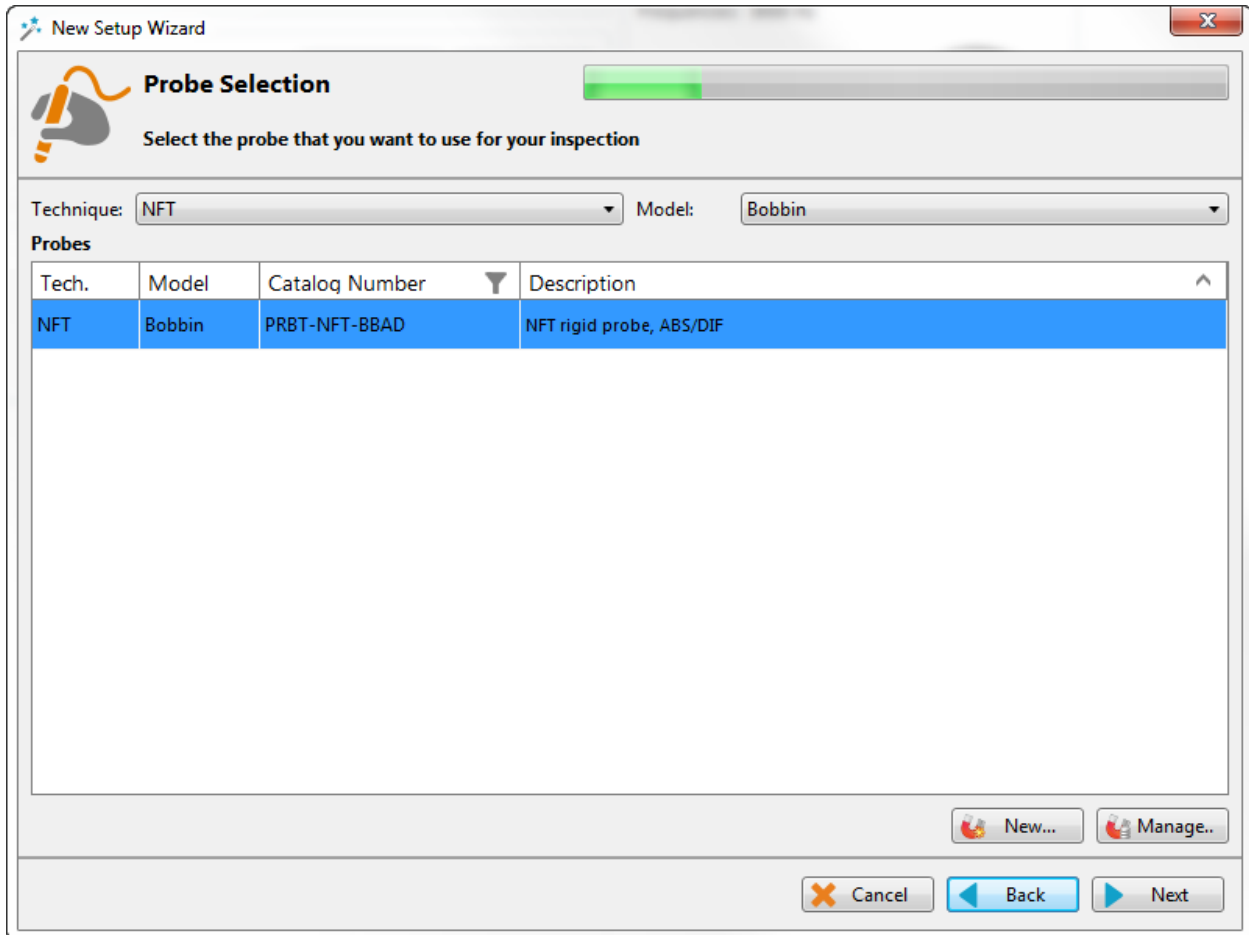

## SCAN DEFINITION

The *Scan Definition* window is used to configure the axial position measurement method, the acquisition rate and the typical probe speed.

**Scan Definition**  
Configure the type of scan you will be performing with your probe

Scan: Single Pass

Main Scan Axis: Y Axis

Position from: Clock

Acquisition rate: 800 Hz

Typical probe speed: 300.0 mm/s

Acquisition Size: 600.000 s  Maximum

Cancel Back Next

The position along the tube can be defined by using either the internal clock of the system, or by using an axial encoder. If you use the internal clock, the default position will be given assuming that the probe is always pulled at the typical probe speed. If the typical probe speed is set to 300mm/s, and the time since the acquisition began was 2 seconds, then the system will indicate a position of 600mm. Using an encoder will give you the exact position of the probe. Note that the position can also be obtained by using the landmark tool, but this feature will be shown later.

The acquisition rate is the number of acquisition points taken per second. By default, the acquisition rate is set to 800 Hz for NFT, but depending on the drive frequency used to inspect, the actual acquisition rate may differ. The system will automatically readjust this value if needed. For standard NFT probes, the acquisition rate can always be set to 800 Hz.

The axial resolution will depend on the combination of the acquisition rate and pulling speed. For instance, with an acquisition rate of 2000 Hz, the pulling speed needs to be less than 1m/s to have at least two points per millimeter. If you do not use a pusher-puller device such as the Probot, the pulling speed won't

be constant. Therefore, it is recommended to target a lower pulling speed to be able to reach your axial resolution target. The typical probe speed should be set as close as possible to its real value. This will help the algorithm that automatically detects landmarks (this will be explained in the Landmarks section). The recommended pulling speed for NFT is approximately 300mm/s.

If you select to measure the position from Encoder, different fields will appear, and a second *Scan Definition* page will become available.

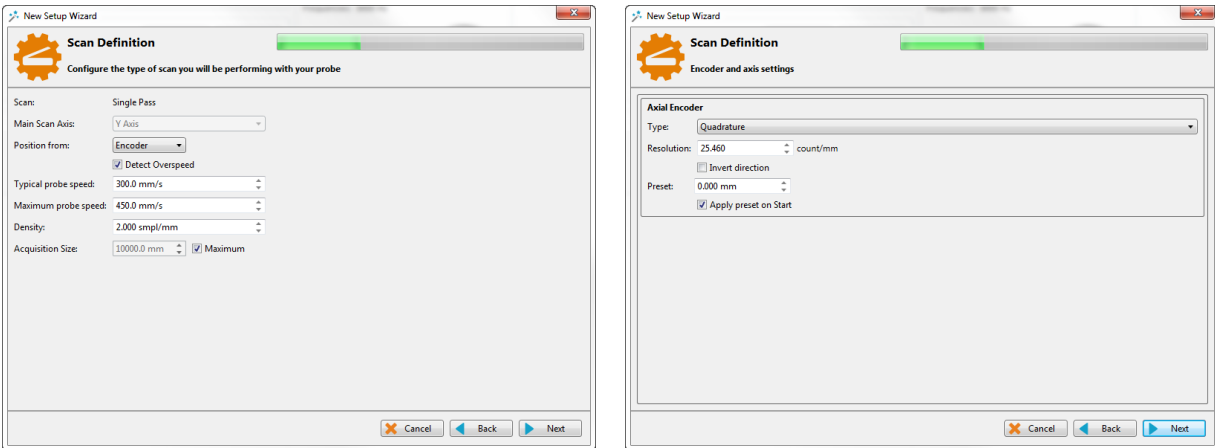

On the first page, the *Typical probe speed*, *Maximum probe speed* and the *Density* will have to be entered. The *Maximum probe speed* is the maximum acceptable speed for your probe and the *Density* is the number of acquired points per millimeter (axial resolution). These values will be used to set the acquisition rate and to optimize the acquisition processes used by the Ectane. Note that if your probe is pulled at a speed exceeding the *Maximum probe speed*, there will be gaps in the data.

The second page includes the type of encoder and its resolution. A preset can also be specified if your acquisition doesn't start at 0 mm.

Click *Next* when you're finished.

## DATA DEFINITION

The *Data Definition* window is used to set the hardware gain, frequency and drive voltage for the *Absolute* and *Differential* channels. It is important to set these parameters correctly before acquiring the data since they are driven by the instrument and cannot be modified during the analysis.

**Data Definition**

Select the channels you will be using and the necessary frequencies

Connector: 19 pins

Channels		
Name	Prefix	Gain (dB)
<input checked="" type="checkbox"/> Absolute	ABS-	60.0
<input checked="" type="checkbox"/> Differential	DIF-	60.0

Required frequencies		
Prefix	Val (Hz)	Ampl (V)
F1	300	5.00

Suggest      + Add

Cancel      Back      Next

By default, Magnifi suggests a frequency of 300Hz. The frequency and the drive voltage can be changed by replacing their values in the *Required frequencies* table. Up to 4 frequencies can be set at the same time. And the sum of their amplitude cannot exceed 10V.

Make sure that the chosen frequencies are within the probe limits that you can find in Table 1. If one of the suggested frequencies is not within the recommended probe frequency range, you can either remove it by clicking on the X or change it within the recommended range.

Click on *Next* when the desired parameters are entered.

The next window is used to build mixed channels. Mixes are processed channels that are mainly used to detect indication close to support plates. They are built with 2 frequencies of the same channel type to attenuate the effect of the support plate and to be able to size an indication at this location more accurately. Mixes are **not** typically used with NFT since this technology allows the detection of inside diameter indications only. Therefore, the support plates are not typically detectable.



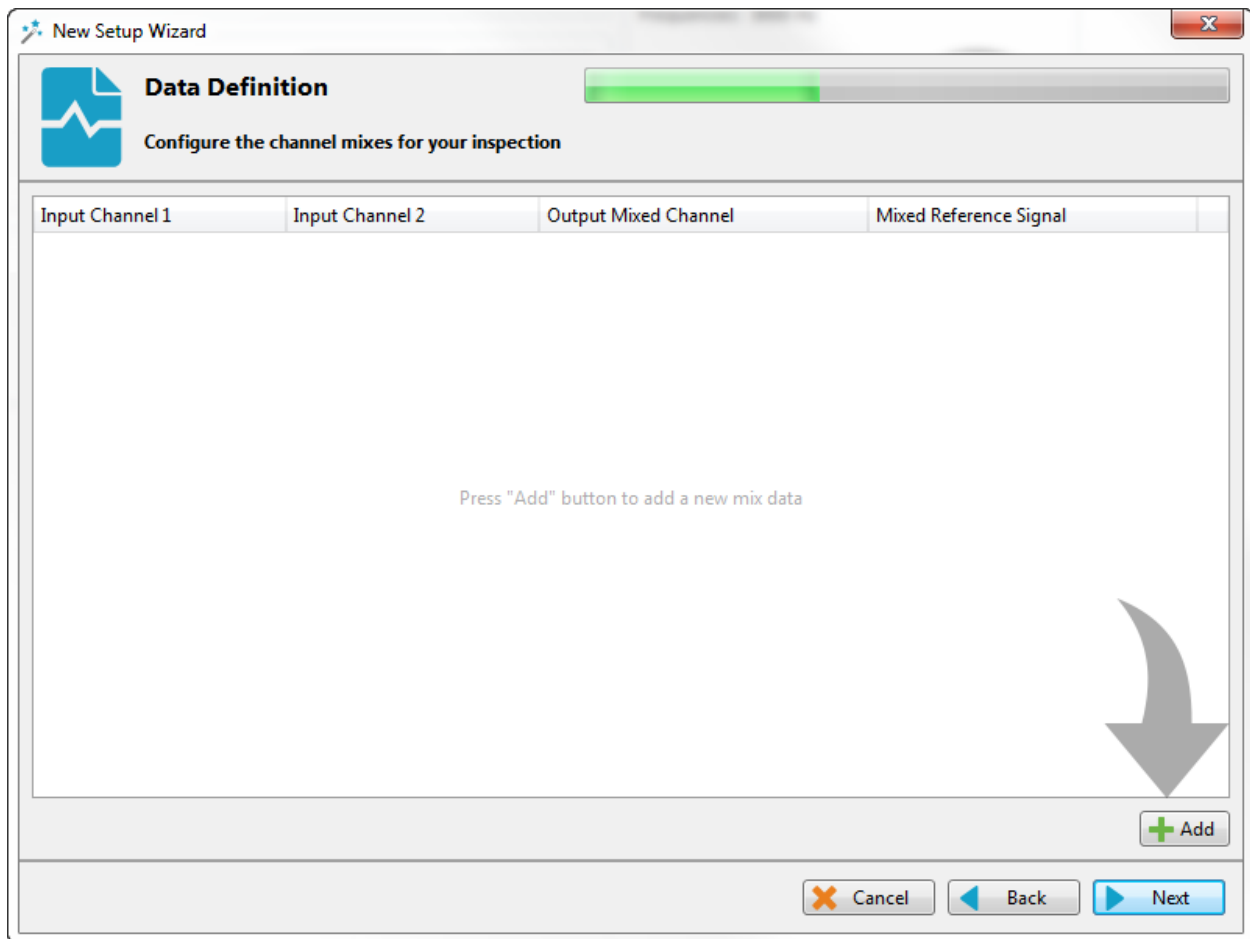

Click on *Next*.

## DATA PROCESSING

The *Data Processing* window is used to configure the signal processing to apply to the channels.

You can choose to configure every frequency individually or you can apply the same filters to every channel with the *Individually configure all the channels* check box.

Note that the signal processing is done after the data acquisition. An inappropriate parameter choice can be changed without any problem during data analysis, while wrong parameters choice for the data acquisition can mislead the analysis. It is possible to change the filters parameters after data acquisition, so it is always possible to fine tune the filters parameters during analysis.

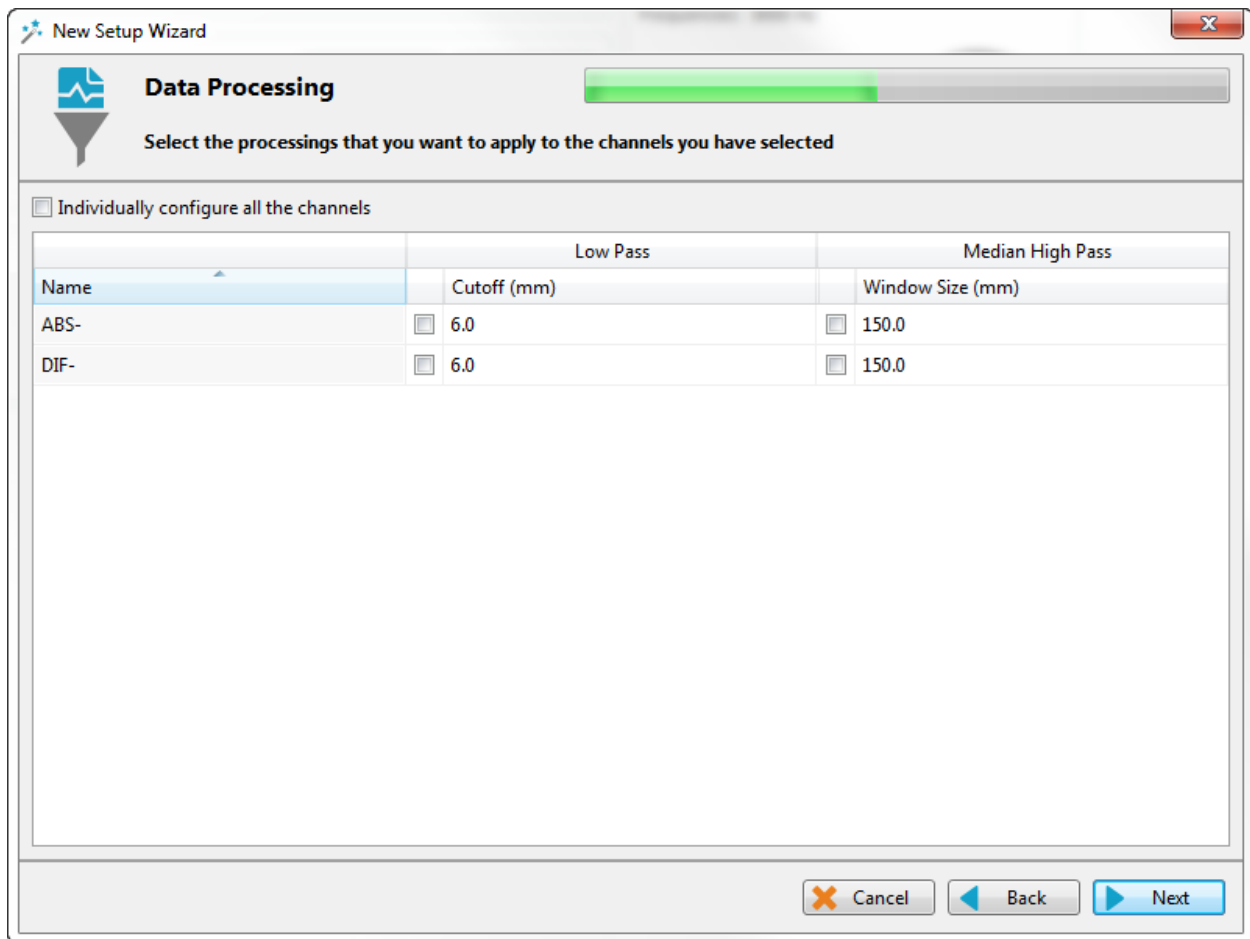

The low pass filter eliminates part of the signal that is above a certain frequency. As an example, it is useful when your defect signal has a lower frequency content than the background noise. In this case, using a filter will remove part of the noise without removing the defect's signals. This may help with data analysis. However, a cutoff frequency that is too high won't remove much noise, and a cutoff frequency that is too low will filter out the defect's signals.

The median high pass filter is used to filter out low frequency noise or drift such as lift-off variations of the probe within the tube, changes in material, geometry or thickness. As a rule-of-thumb, the width of the high-pass median filter should be set to at least three times the axial length of the longest flaw that may be encountered. Data should be examined in both its filtered and unfiltered states. It is important to keep in mind that the median high-pass filters can distort phase. More information about median filters for NDT analysis can be found on Eddyfi's blog.

Click *Next* when you are done.

## CALIBRATION POINTS

The *Calibration Points* page is used to define the points in your calibration tube. These indications will later be used to calibrate your probe and to build sizing curves.

The units of measurement can be set in percentage or in depth (millimeters or inches).

You can add calibration points by clicking on the *Add* button. Specify the calibration point name, side and size. The side and size of the flaw will be used to position the calibration point on the sizing curve(s).

Calibration points can also be imported with the *Import* button.

New Setup Wizard

### Calibration Points

Configure calibration points used for channels and sizing curves

Units of measurement: Percentages (%)

Name	Side	Size	
HOLE	Through	100.0	X
RBH-75	ID	75.0	X
RBH-50	ID	50.0	X
RBH-25	ID	25.0	X
GR-30	ID	30.0	X
GR-60	ID	60.0	X
SUPPORT	Unknown	0.0	X

Import Add

Cancel Back Next

Click *Next* when you have set the required calibration points for your calibration(s) and sizing curve(s).

## CALIBRATION

The *Calibration* page is used to define reference signal(s) that will be used to set the amplitude(s) and phase(s) of each channel using the selected measurement method.

By default, the calibration is performed on the Hole signal by adjusting it to 1V and 90° on the differential channel. The absolute channel is calibrated on the 60% groove by adjusting it to 6V, 90°. However, the calibration can be done differently on each channel type. It can also be done individually for each frequency by selecting the *Individually configure all the channels* option. Different reference signals can be set to calibrate the phase and the amplitude independently.

New Setup Wizard

### Calibration

Configure parameters to calibrate channel amplitude and phase

Individually configure all the channels

Name	Amplitude			Angle (°)	Phase	
	Voltage (V)	Reference	Measurement		Reference	Measurement
ABS-	6.00	GR-60	PP	90.0	GR-60	PP
DIF-	1.00	HOLE	PP	90.0	HOLE	PP

Cancel Back Next

When you select the reference signal, the system will use the selected measurement method to apply a rotation and a gain. Here is a short description of the available options:

- 1. Absolute (A):**  
Uses a straight line from the Lissajous origin to the main cursor position to measure amplitude.
- 2. Absolute Horizontal (AH):**  
Uses only the horizontal component, from the Lissajous origin to the main cursor position to measure amplitude.
- 3. Absolute Vertical (AV):**  
Uses only the vertical component, from the Lissajous origin to the main cursor position to measure amplitude.
- 4. Absolute Peak (AP):**  
Uses a straight line, from the Lissajous origin to the peak value of the data selection, to measure amplitude.
- 5. Absolute Peak Horizontal (APH):**  
Uses only the horizontal component, from the Lissajous origin to the peak value of the data selection, to measure amplitude.
- 6. Absolute Peak Vertical (APV):**  
Uses only the vertical component, from the Lissajous origin to the peak value of the data selection, to measure amplitude.
- 7. Average Peak (MP):**  
Takes the distances from points at the extremity of the cursor to the peak of the data selection to build an average vector. Only used and recommended for absolute signals.
- 8. Average Peak Horizontal (MPH):**  
Uses the horizontal component of the distances from points at the extremity of the cursor to the peak of the data selection to make an average vector. Used for absolute signals.
- 9. Average Peak Vertical (MPV):**  
Uses the vertical component of the distances from points at the extremity of the cursor to the peak of the data selection to make an average vector. Used for absolute signals.
- 10. Peak to peak (PP):**  
Uses the combination of the vertical and horizontal component to measure the maximum amplitude.
- 11. Horizontal (PPH):**  
Uses only the horizontal component to measure the amplitude.
- 12. Vertical (PPV):**  
Uses only the vertical component to measure the amplitude.
- 13. Peak to peak First Transition (PPF):**

Uses the combination of the vertical and horizontal component of the first transition of the signal to measure maximum amplitude. The first signal transition is from the base of an indication to its peak.



Click on *Next* when the parameters in the table are set according to your requirements.

## SIZING CURVES

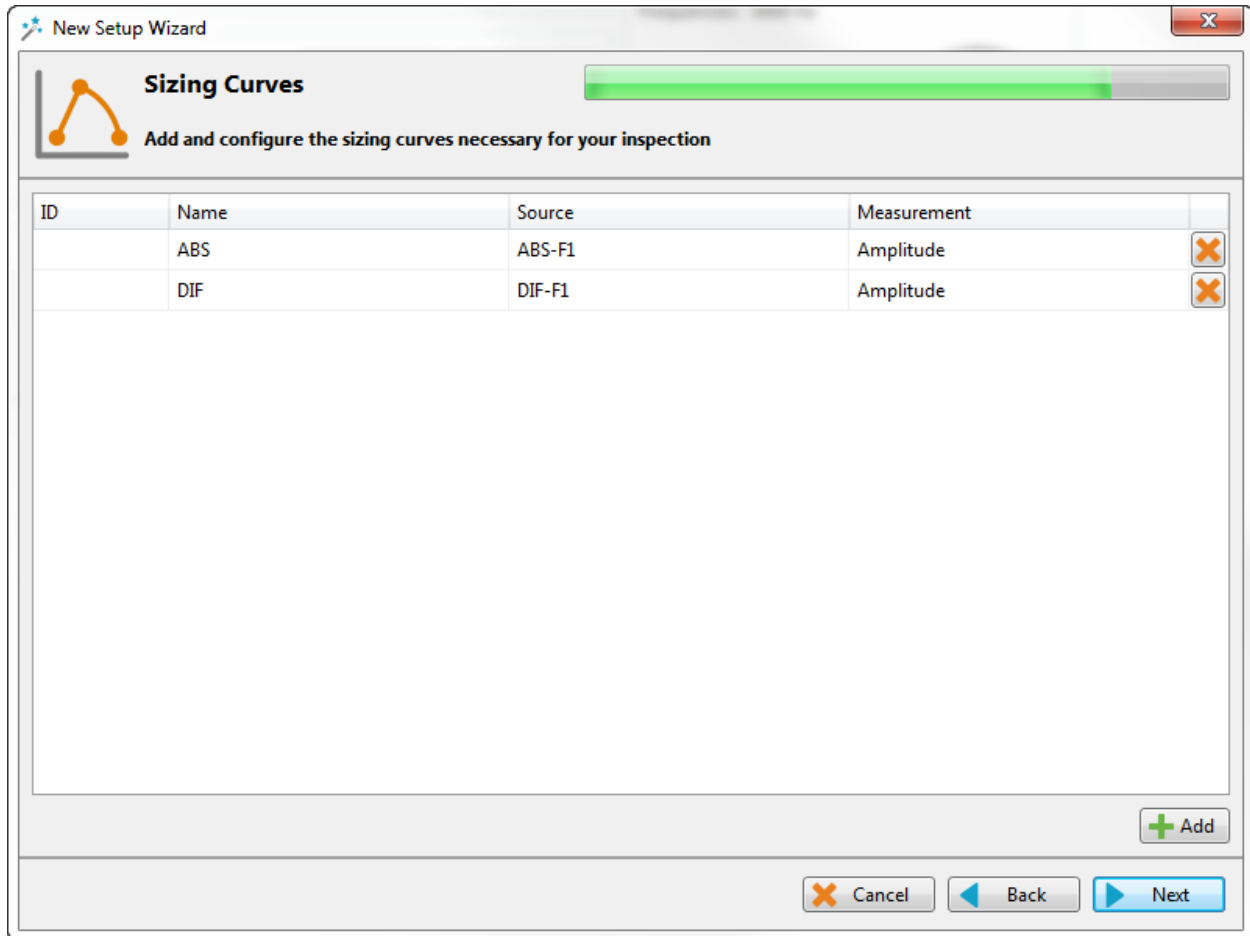
The first page of this section is the definition of your sizing curves. A curve will be built for each line in this table.



The screenshot shows a software window titled "New Setup Wizard" with a sub-tab "Sizing Curves". The window contains a table with the following data:

ID	Name	Source	Measurement	
	ABS	ABS-F1	Amplitude	
	DIF	DIF-F1	Amplitude	

Below the table is an "Add" button with a green plus sign. At the bottom of the window are three buttons: "Cancel" (with a red X icon), "Back" (with a left arrow icon), and "Next" (with a right arrow icon).

The sizing curve will allow you to estimate the size of a defect based on the calibration points signals (amplitude only for NFT) obtained with your calibration standard. Magnifi will give you the interpolated flaw size based on the built sizing curves.

Sizing curve names are customizable. The channel source and measurement type can also be changed. You can add sizing curves by clicking on the *Add* button.

Click *Next* when you are done.

For every sizing curve created in the last window, a window will appear to configure the curve properties. The name of the curve will be shown in the upper left corner of the page (ABS in the example below).

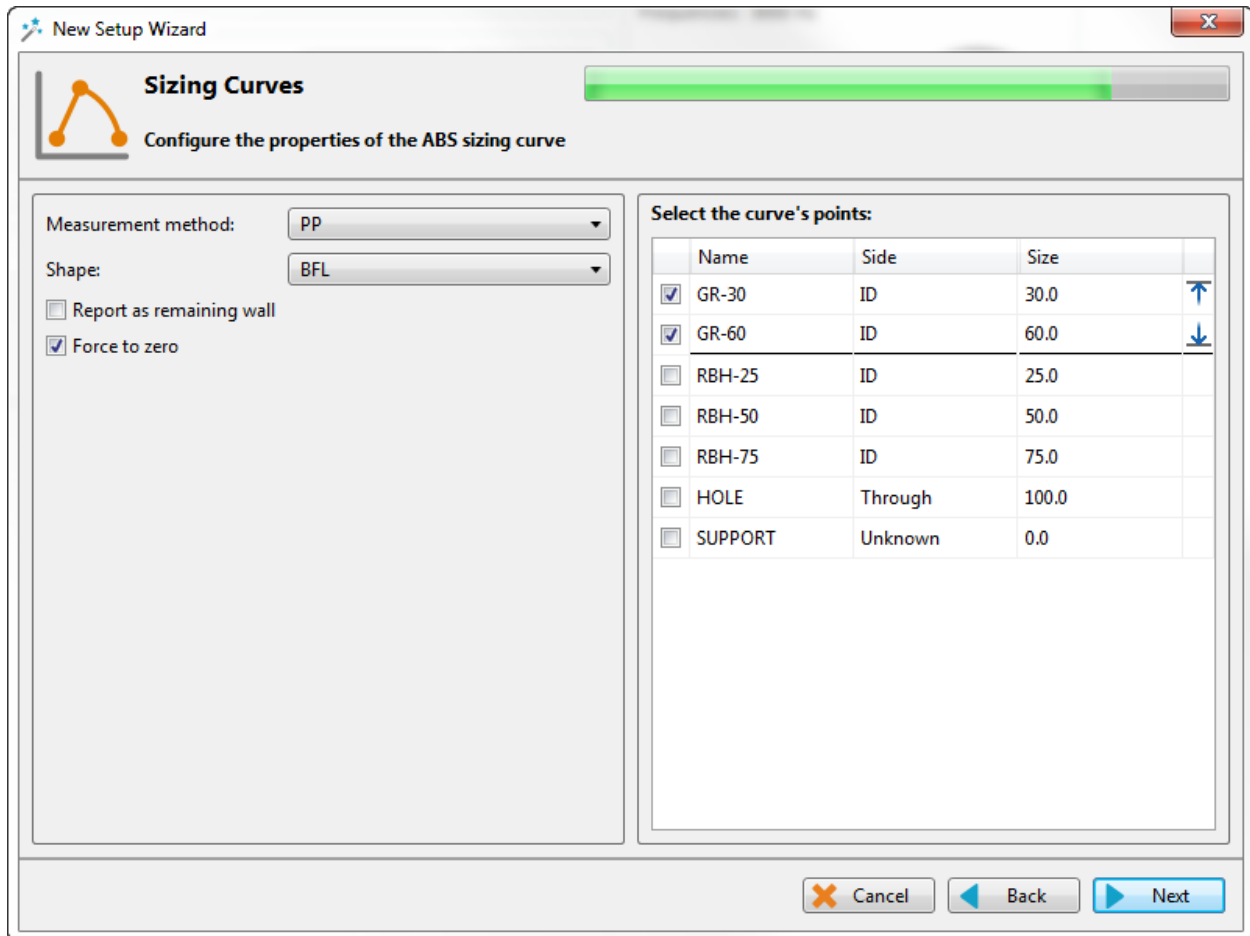

The measurement method options are the same as what is described in the calibration section of this document. By default, the option *peak to peak (PP)* option is set for the absolute and the differential channels.

The interpolation method can be selected with the *Shape* dropdown menu. Here is a short description of the available options:

1. **Best Fit (Dual linear) (for phase measurement only):**  
A curve with two linear segments representing ID and OD (or Near and Far) side calibration points with respect to phase.
2. **Best Fit (Dual Slope) (for phase measurement only):**  
A curve with two segments representing ID and OD (or Near and Far) sides. The ID section is linear and the OD section is polynomial. The OD side of the curve will need at least three points (including the hole) in order to trace a polynomial curve.
3. **Best Fit (Polynomial) (for phase and amplitude measurements):**  
Best polynomial (degree 2) interpolation within the measured calibration points (requiring at least three points).

4. **Connected Points (for phase and amplitude measurements):**  
Simple, point-to-point curve.
5. **Best Fit (Linear) (for phase and amplitude measurements):**  
Best linear interpolation within the measured calibration points
6. **Best Fit (Dual Polynomial) (for phase and amplitude measurements):**  
Polynomial (degree 2) interpolation with two segments for both ID and OD side of the curve.  
Need at least three points.

The linear options are mostly used when few data points are available, while the Best fit (Dual Polynomial) option is a more precise method when your calibration tube has multiple defects.

Once the measurement method and the interpolation curve shape are chosen, you can select the curve points for each sizing curve previously created. The order in which the points appear in the list may influence your sizing curve. Make sure that the measured values of the calibration points are in ascending order on the list. You can set Magnifi to show the remaining wall instead of the defect size by checking the box *Report as remaining wall thickness*.

Click *Next* when you are done.

## INDICATION CODES

The *Indication Codes* page is used to define the entries that can be added to the report when analyzing the data.

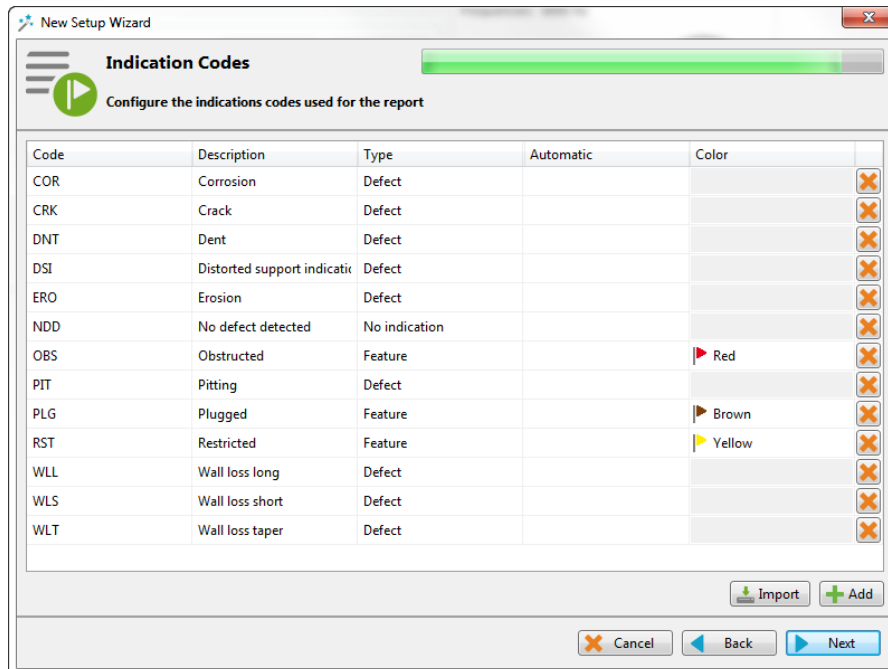

When an indication is added, its abbreviation (code) is shown in the code pane, next to the data.

You can modify the default indications codes list by changing the parameter in the table. New indications can be defined by clicking on the *Add* button.



Click *Next* when you are done

## DISPLAY

The first *Display* window is used to set how the data is displayed during and after the acquisition.

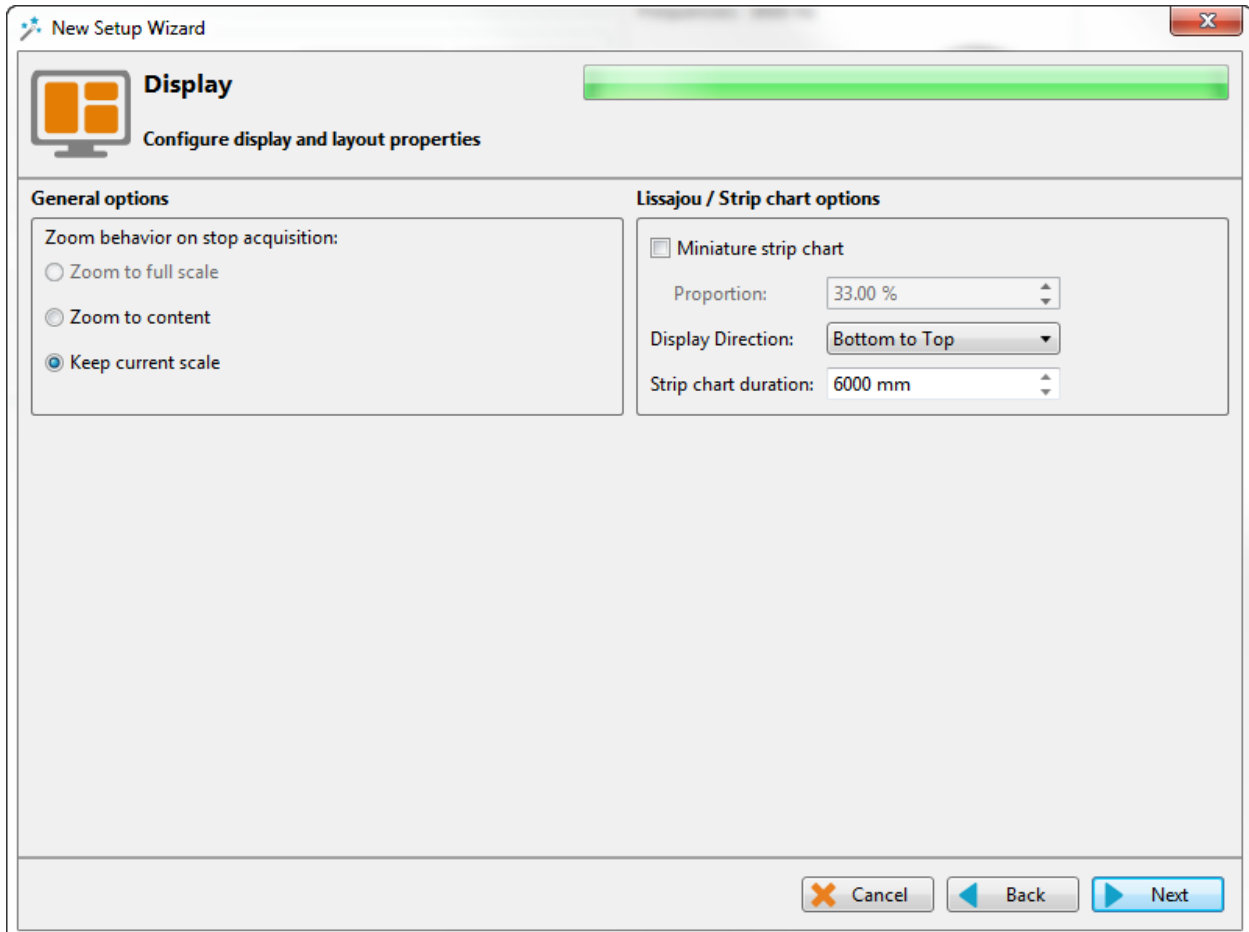

The *Display Direction* is the direction in which data appears on the screen.

You can enable/disable the miniature strip chart under the Lissajous by checking/unchecking the box.

The strip chart duration is the length of a Strip chart window when the data is acquired.

Click *Next*.

The second *Display* window is used to set the layouts. Checking the tick boxes in this window will make the proposed layouts available in your setup. You will be able to switch from one to the another via the layout tab. The " S " stands for Strip chart, " L " for Lissajous and " C " is for the defect Code indication zone.

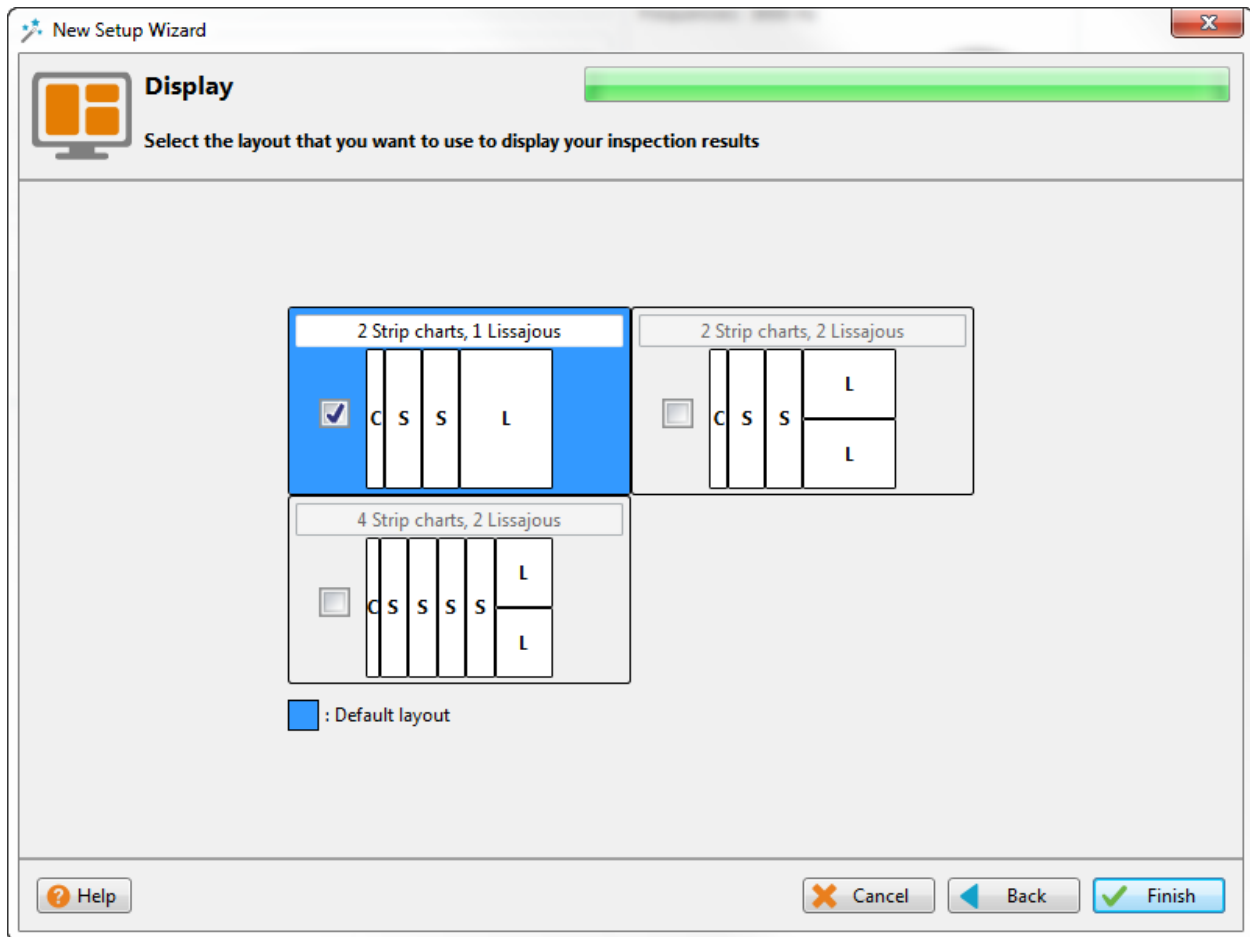

The layout with the blue background will be the one opened by default, which can be changed to your desired option.

Layouts can be readjusted at any time.

Click *Next* to complete the setup wizard process.

## SETUP MODIFICATIONS

Some parameters or preferences may need to be modified after the *Setup Wizard* process. To modify the parameter previously entered, you can go to the *Setup* tab in the *Frontstage* and click on the button associated with the parameter you want to change.

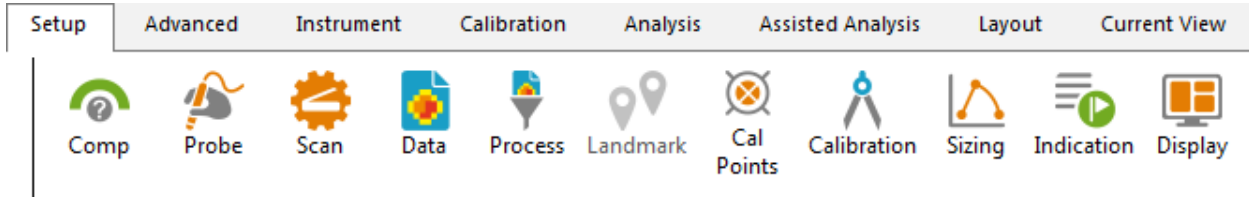

This will open one of the windows previously described, where you change the values you originally entered. Change the desired parameter. If applicable, go through the process by clicking on *Next*, and then click on the *Finish* button. This will apply the modification to the setup.

Advanced settings can be found under the *Advanced* tab of the *Frontstage*. If parameters are changed using advanced settings, the information shown using the *Setup* tab may not match your actual setup.

## SMART SETUP TOOLS

Additional functions, which facilitate data analysis, can be set up under the SMART Setup tab.

## LOGBOOK

The first button on the left side under the SMART Setup tab allows you to enable or disable the logbook.

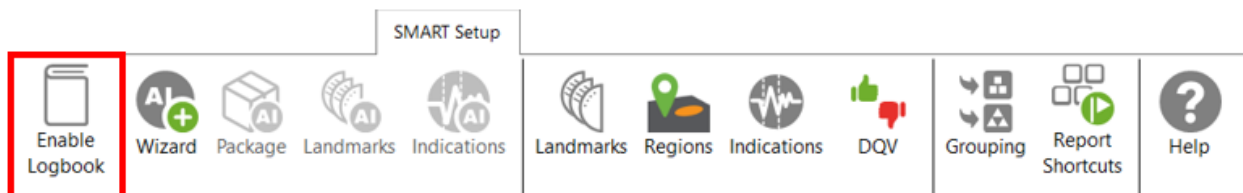





The logbook stores information about the analysis in addition to allowing the following functions: batch screening, seeing results at a glance from the data list pane and saving manual modifications made to the landmarks during the analysis.

The logbook stores the following information: landmarks (type, position, dimension, including manual modifications), indications (AI and conventional, label, position, dimension, etc.), indication grouping, and data quality validation results. When enabled, an additional column is added to the data file list to allow seeing results and to filter, sort, or analyze according to these results.

Zone	Row	Col	Icon
✓ 000	001	001	7 (dashed circle with red X)
✓ 002	005	005	3 (dashed circle with green checkmark)
✓ 002	009	007	2 (dashed circle with green checkmark) 2 (red arrow)
✓ 003	004	009	2 (dashed circle with green checkmark) ✓ (green checkmark)
✓ 003	005	012	2 (dashed circle with green checkmark)
✓ 003	006	007	8 (dashed circle with green checkmark)
✓ 003	007	006	1 (dashed circle with green checkmark)
✓ 003	007	010	1 (dashed circle with green checkmark)
✓ 003	009	007	
✓ 004	003	010	10 (dashed circle with red X) 2 (red arrow)
✓ 004	003	015	1 (dashed circle with green checkmark) ✓ (green checkmark)
✓ 004	004	009	18 (dashed circle with red X) 2 (red arrow)
✓ 004	004	014	27 (dashed circle with green checkmark) 3 (red arrow)
✓ 004	005	008	○ (dashed circle) ▶ (red arrow)
✓ 004	007	005	○ (dashed circle) ✗ (red X)
✓ 004	007	015	1 (dashed circle with red X)
✓ 004	009	010	2 (dashed circle with green checkmark)
✓ 004	010	010	⚠ (yellow warning triangle)

The following table shows the possible icons and their meaning:

Icon	Description	Meaning
(empty)	Empty	No logbook entry associated with this file because it has not been screened yet.
○	Dashed outline circle, without a number	Logbook entry associated with the file contains information such as landmark detection or regions. The absence of additional information on the icon reveals that no indication detection engine or DQV tests were enabled when the logbook was written.
①	Dashed outline circle, with a number	Logbook entries associated with the file contains information such as landmark detection as well as detected indications. The number displayed inside the circle shows the quantity of potential indications detected. No DQV tests were enabled when the logbook was written.
○✓	Dashed outline circle, with a green check mark	The green check mark indicates that the DQV test(s) passed on this file.

	Dashed outline circle, with a red cross	The red cross indicates that at least one DQV test(s) failed on this file.
	Dashed outline circle, with a number, with a green check mark	The logbook entries associated with this file indicates that potential indications have been detected by the detection engine and that the DQV test(s) passed.
	Dashed outline circle, with a number, with a red cross	The logbook entries associated with this file suggest that potential indications have been detected by the detection engine and that at least one DQV test(s) failed.
	Orange warning triangle	The AI detection tools identified an unusual situation. In this case, the level of confidence in the detection findings could be very low. Therefore, users should pay special attention when reviewing the detection results.

The logbook is saved within the inspection folder. Its data is written when a file is screened using the dedicated buttons in the Analysis ribbon. It is also automatically written when a file is loaded while the logbook is enabled, and no logbook entry existed for this file yet.

It is worth mentioning that the logbook also includes defects and landmarks, even if these have been detected with detection tools that do not use AI (conventional landmark detection and indication boxes). Also note that the automatic indication detection tools are not available if you use the acquisition license (ACQ).

## LANDMARKS

The Landmarks button is used to setup the parameters for landmark detection with conventional tools.

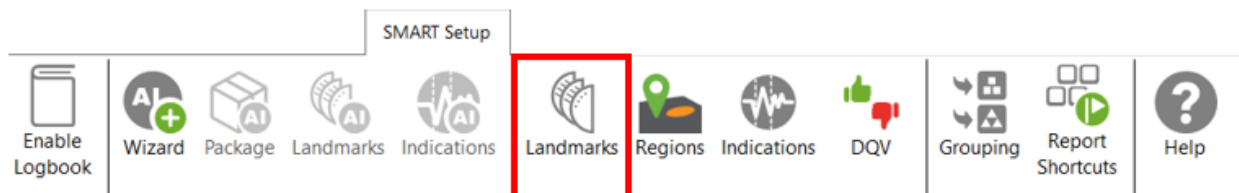

The Landmark Detection window is used to configure the automatic detection of features such as tube sheets and support plates. Landmarks are not mandatory and don't need to be set to have functional setup. They can however give a reference for the axial position in a tube. They can also be used by the software to trigger automatic acquisition sequences.

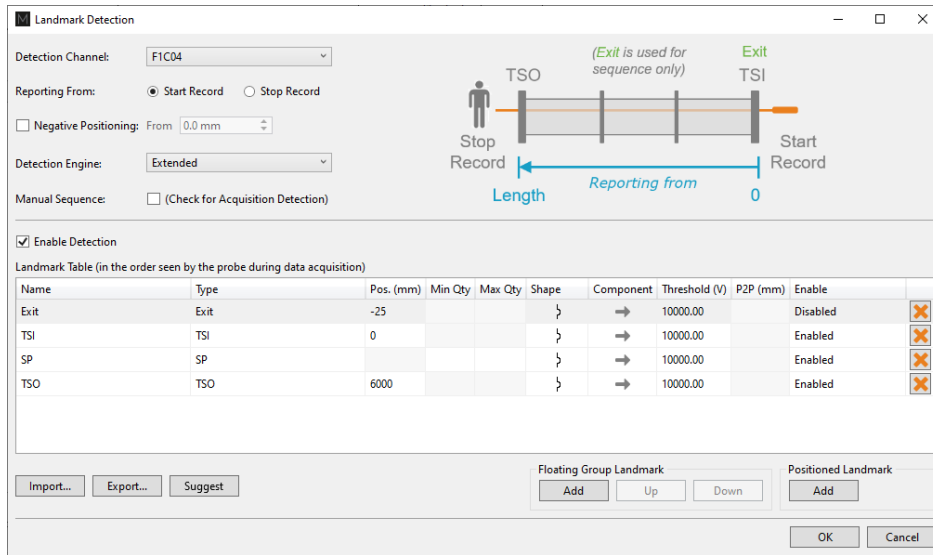

Three landmarks are created if you press on the Suggest button. The channel selected to detect these landmarks should be the lowest frequency absolute channel. The R\_ before the channel stands for Raw. This is the signal of the channel without software filter, rotation, or software gain applied.

You can base the position of your landmarks either on the location where you start to record (usually the tube entrance, opposite from the operator position) or on the place you stop to record (usually the operator side).

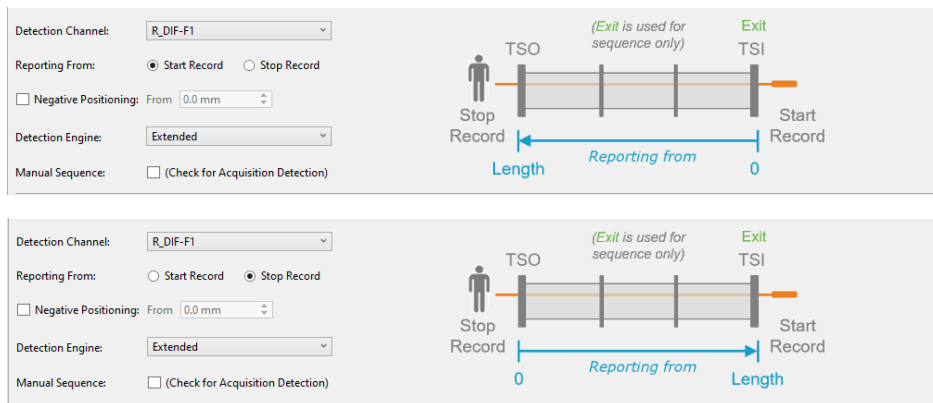

In the above example, the Exit landmark is detected when the probe exits the tube at its outer end. It has a negative position because this event happens before entering the tube. It is enabled only when doing the acquisition.

TSI is the first tube sheet encountered when the probe is pulled. TSO is the last tube sheet encountered at the end of the acquisition.

Landmark detection can be set up manually by describing the shape, component, and voltage threshold that will trigger the detection. The Shape describes the appearance of the signal when the landmark is reached. If a differential signal shape is chosen, the Peak-to-Peak distance ("P2P") will also be needed. The Direction is the projection axis (horizontal or vertical) of the Lissajous signal that will be taken to trigger the landmark. And the Threshold is the voltage amplitude threshold.

Landmarks can be calibrated on real signals; in this case, there is no need to change these parameters as they will be automatically measured by the software. It's important to set the landmark positions as accurately as possible. If the position is not accurately set, the software might prevent their automatic detection since it won't be at an expected position.

The Type field is a name that associates the calibration point with the landmark. If landmarks share the same Type, they will be calibrated at the same time using the same point and process. To associate two landmarks with the same Type, their signal must be the same. If support plates of the same geometry are present in a bundle, they can share the same Type. In the above example, TS1 and TS2 don't share the same Type because one is triggered when the probe goes inside the tube and the other is triggered when the probe exits the tube.

The Detection Engine drop-down menu can be set to Legacy or Extended. With the Legacy mode, all the landmarks need to be entered with the right position. The system will look for the exact number of landmarks entered at positions close to those entered in the table. With the Extended mode, the system will look for a number of landmarks between the Qty max and the Qty min. With this mode, the exact number of support plates don't need to be constant or known.

## REGIONS

The Regions option allows the user to define inclusion/exclusion zones based on Landmarks. This is used to categorize the data to process correctly. For example, they can be useful for restricting the detection of channel saturation to an area within the tube or specify an automatic analysis type for a given region (e.g., under the tubesheets).

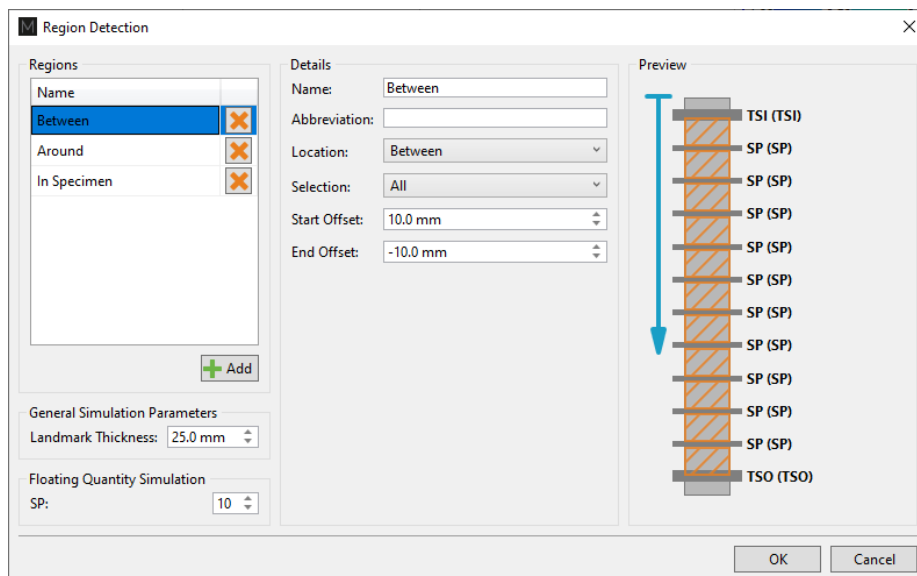
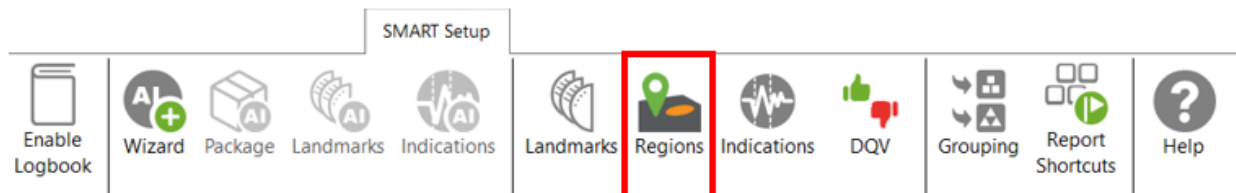

If you are using the conventional detection tools, you can set up the regions according to the automatic analysis tools you will use with the Indications and DVQ buttons (described later).

## INDICATIONS

The Indications module allows the user to define various zones or even waveform types to trigger a certain detection threshold.



These detection zones can be applied to conventional channels and C-scan channels. The Label is the name that will appear in the Code view.

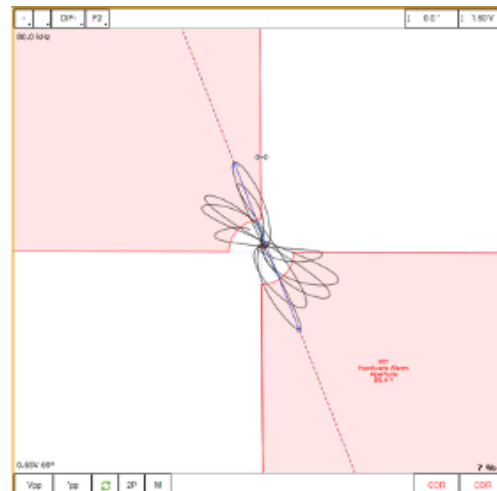
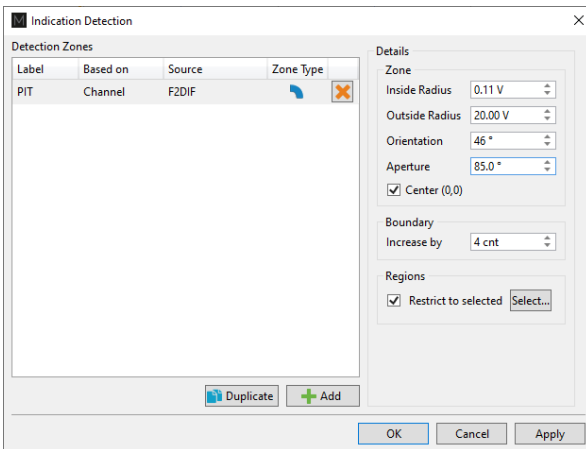





There are five zone types:

	Absolute pie
	Differential pie
	Centered rectangle
	Rectangle
	Over or under a horizontal or vertical threshold

And seven waveform types:

	Up
	Down
	Down-up



	Any direction
	Up-down
	Down-up-up
	Up-down-up-down

Each zone or waveform can be linked to a defined region, and thresholds can be set. The zone types also include the boundary setting to prevent signal oscillation from triggering unnecessary detections.

Detection zone parameters can also be set by clicking on the Lissajous of the used channel and activating the Edit Alarm option on the Current View tab.

The detected indication can be found in the Indication window, which can be activated in the Layout tab.

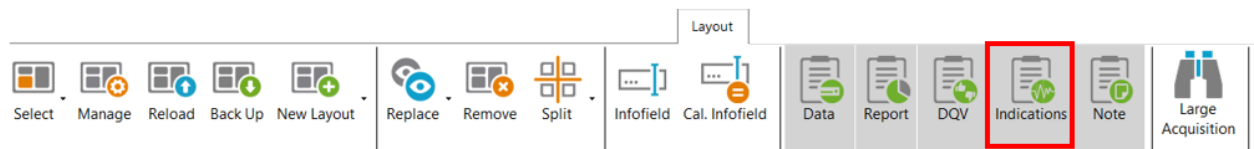

Clicking on an indication in the pane instantly positions the cursor on the selected indication in the Strip chart view. If you click on an indication in the code view (described later), the associated indication is highlighted in the Indications pane.



## DATA QUALITY VALIDATION (DQV)

Data Quality Validation allows defining tests to validate the quality of the data.

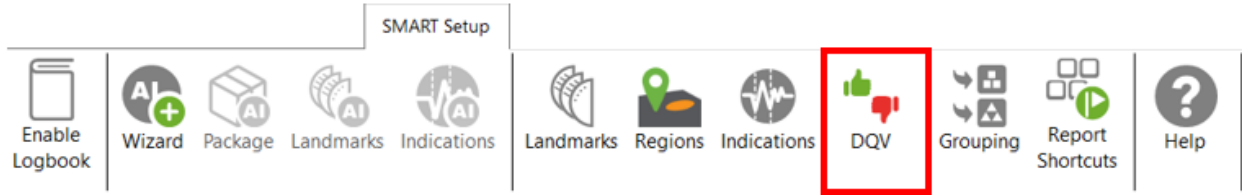

Five test types are available. To add a test, click on the Add button on the DQV page and select the test type with the drop-down menu. Parameters associated with this test can be changed in the Details section of the DQV window.

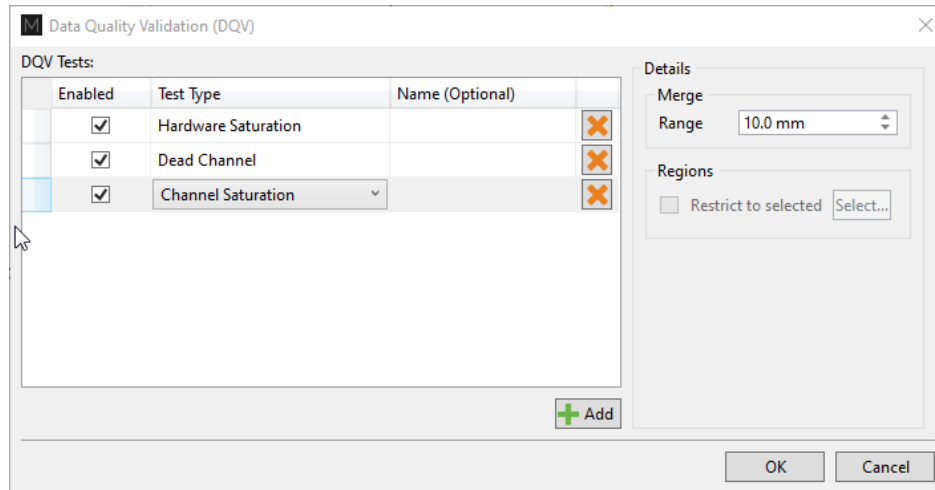

- **Dead Channel:** Verify that channels are reading a signal whose amplitude is above a defined threshold. An amplitude that remains below the threshold throughout the scan indicates a dead channel.
- **Landmark Detected:** Verify the presence of all the selected landmark names in the Details section. To validate full tube-length of straight bundles for ECT bobbin data using AI detection, select this option and check the TSI and TSO landmarks. When AI setup for landmarks is completed and the TWH calibrated, the DQV test will automatically use the AI results to perform the test.
- **Hardware Saturation:** Verify if signal saturation appears on raw channels. The merge field allows grouping a zone together for which the test has failed. This function avoids having many notifications if the test fails several times in one area. This test can be limited to a specific region, for example, the areas inside the tube.
- **Channel Saturation:** Verify if signal saturation appears on calibrated channels. The merge field allows group a zone together for which the test has failed. This function avoids having many notifications if the test fails several times in one area. This test can be limited to a specific region.
- **C-scan Saturation:** Verify if signal saturation appears on C-scans. The merge field allows grouping a zone together for which the test has failed. This function avoids having many notifications if the test fails several times in one area. This test can be limited to a specific region.

The results of the DQV tests can be found in the DQV window, which can be activated in the Layout tab.

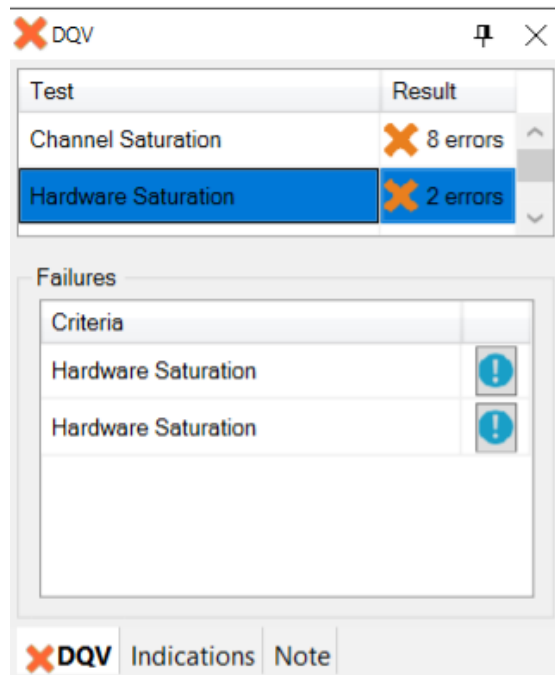
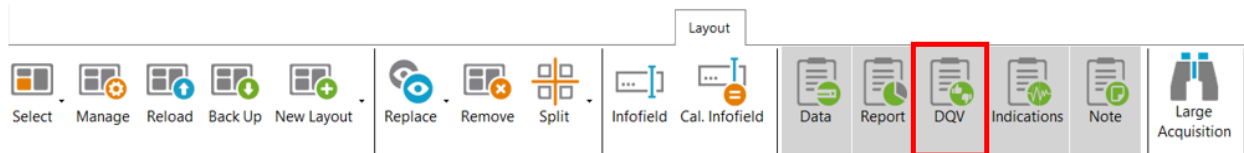

## GROUPING

The grouping tool can help the analyst find critical indications for review as it categorizes and groups the automatically detected indications.

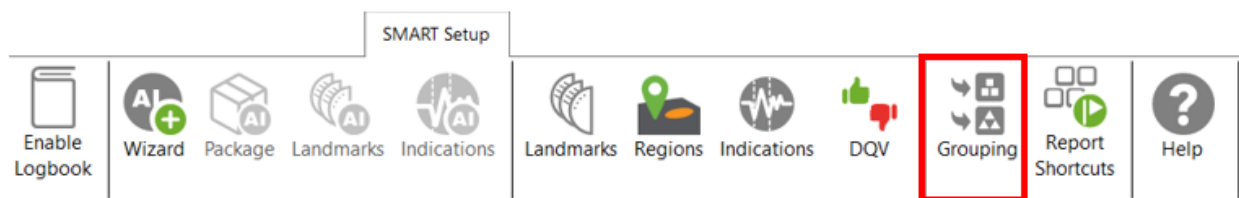

The Grouping menu offers a default configuration with three predefined categories:

- Support Plates
- Critical
- Less Critical

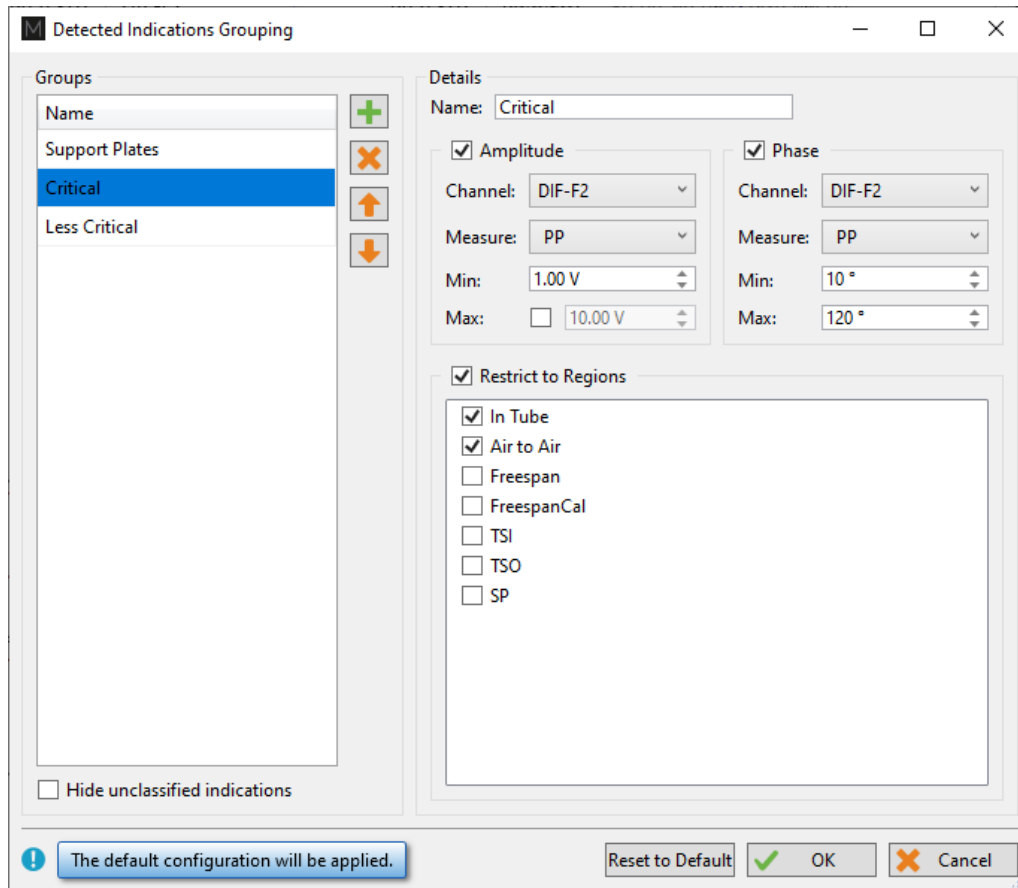

The Details section of each group shows the parameters defining the conditions that must be met for a detected indication to be classified in this group. The user can modify all parameters.

By default, the Support Plates group is configured with the mix channel with a Peak-to-Peak (PP) measurement method, and Max/Min threshold values are set for amplitude and phase. For this group, the criteria are limited to indications detected under the SP regions. As a result, the indications detected under support plates for which all conditions are true will fall into this category.

Critical and Less Critical are two other groups predefined in the Grouping window. Both groups are set on DIF-F2 channel, but with different Amplitude/Phase measurement settings. In both cases, the grouping criteria is restricted to In Tube and Air to Air (for calibration tubes) regions, which covers the full-tube length data.

It should be noted that each automatically detected indication can only be categorized in a single group. Also, the grouping operation is executed according to the order of the groups defined in the Groups list. Therefore, if a given indication meets all the criteria of the first group, it will be categorized in this group. If not, it will be passed to the following group. If it meets all the criteria of the second group, it will be categorized into this one. If not, it will again be passed to the next group, and so on. If an indication does not meet the criteria of any group, it will be placed in the Unclassified group. This implies that every single indication will be categorized, and none can appear simultaneously in more than one group.

New groups can be created with custom parameters.

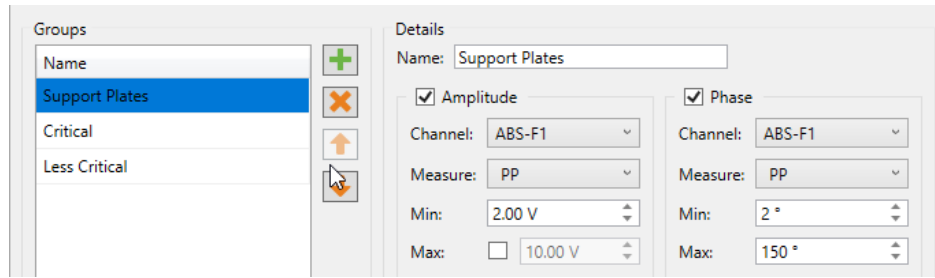

It is also possible to remove a group or use the up/down arrow keys to change the group priority within the list.

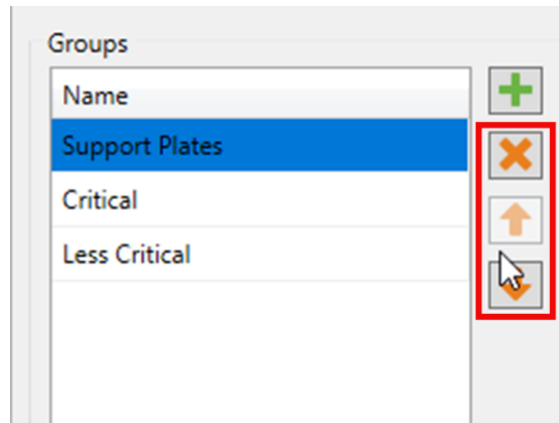

In the Front stage interface, the Grouping results will be displayed in the Indications pane.

Indications 10 of 10 results

Label	Ampl.	Phase
<b>^ Critical (4)</b>		
IND	14.15 V	82 °
IND	3.40 V	83 °
IND	2.78 V	106 °
IND	7.06 V	16 °
<b>^ Less Critical (4)</b>		
IND	1.02 V	111 °
IND	1.00 V	40 °
IND	1.27 V	56 °
IND	1.13 V	73 °
<b>^ Unclassified (2)</b>		
IND		
IND		

DQV Indications Note

To help the analyst focus on the most relevant detected indications furthermore, it is possible to hide the Unclassified indications. To accomplish this, check the box “Hide unclassified indications” at the bottom of the Grouping menu and click on OK.

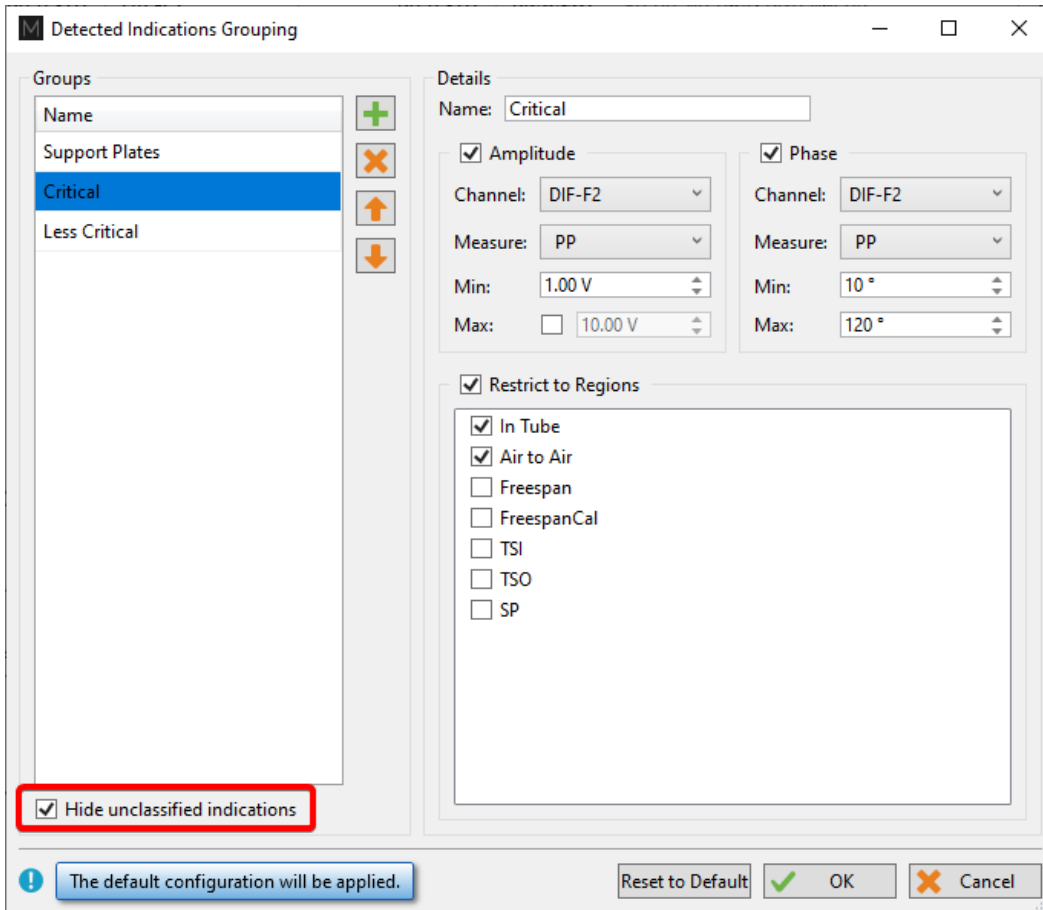

Enabling this option influences the following elements of the software:

- Indications pane;
- Code view;
- Logbook column.

The images below compare them when the Unclassified indications are shown (left) and when they are hidden (right).

When the option is enabled, the Indications pane will not show the “Unclassified” group. The count in the header serves as a reminder to the user that not all indications are currently shown.

Indications 26 of 26 results

Label	Ampl.	Phase
<b>^ Critical (1)</b>		
IND	1.53 V	17 °
<b>^ Less Critical (5)</b>		
IND	1.00 V	14 °
IND	0.93 V	10 °
IND	0.84 V	18 °
IND	0.76 V	17 °
IND	1.20 V	19 °
<b>^ Unclassified (20)</b>		
IND		
IND		
IND		
IND		
IND		

DQV **Indications** Note

Indications 6 of 26 results

Label	Ampl.	Phase
<b>^ Critical (1)</b>		
IND	1.53 V	17 °
<b>^ Less Critical (5)</b>		
IND	1.00 V	14 °
IND	0.93 V	10 °
IND	0.84 V	18 °
IND	0.76 V	17 °
IND	1.20 V	19 °

DQV **Indications** Note

In the Code view, the red markers from the Unclassified indications have been removed.

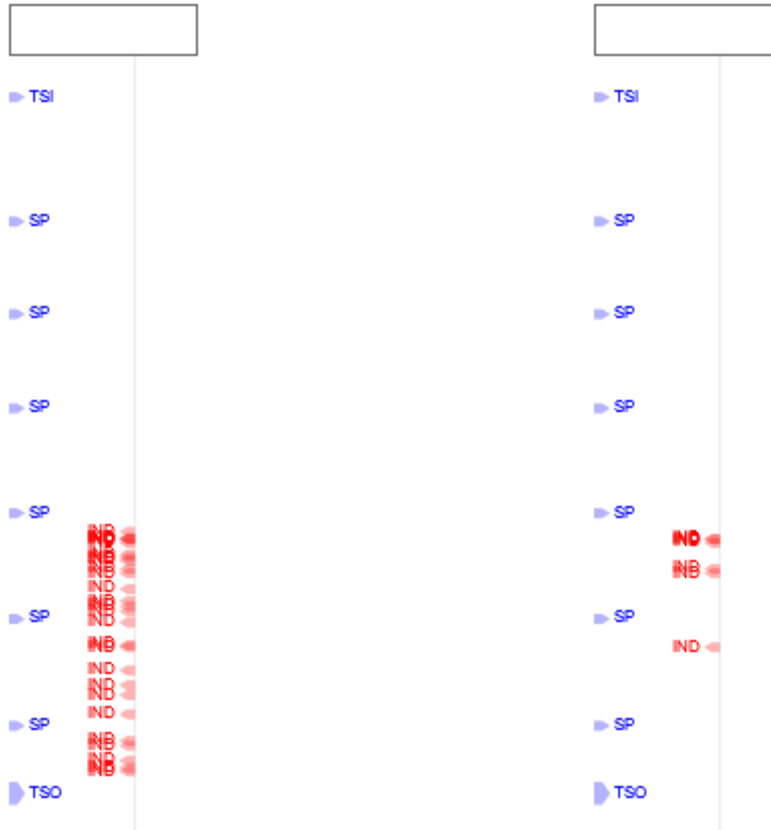

In the data file list, the number shown in the Logbook column represents the number of visible indications, matching the number shown in the header of the Indications pane.

Data		↑	×
7 of 7 data		⏏	
Row	Col		
✓	201000001		
✓	201004005		
✓	<b>201006009</b>	(26)	
✓	201006016		
✓	201024022		
✓	201025017		
✓	201025019		

Data		↑	×
7 of 7 data		⏏	
Row	Col		
✓	201000001		
✓	201004005		
✓	<b>201006009</b>	(6)	
✓	201006016		
✓	201024022		
✓	201025017		
✓	201025019		



## REPORT SHORTCUT

Keyboard shortcuts can be used to make entries in the report. By opening the shortcut window, it is possible to select a channel with a measurement method and to associate an indication with it.

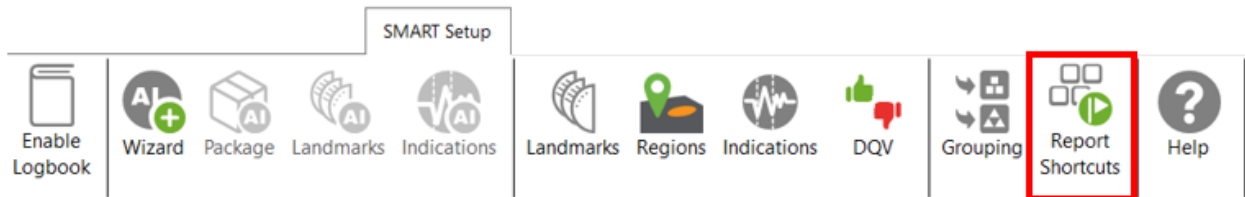

For example, we could use the differential channel F2 with a Peak-to-Peak measurement method to enter pits in the report.

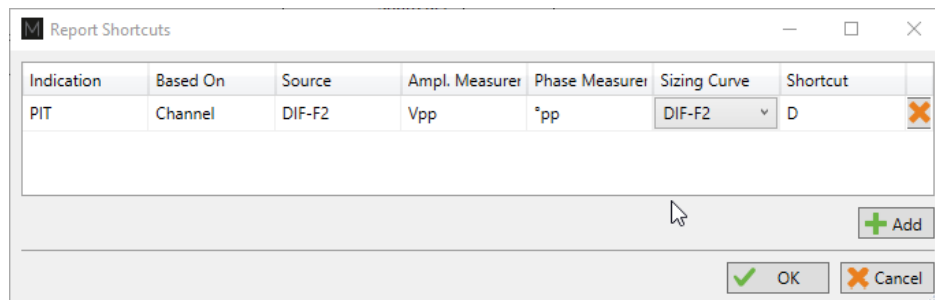

To select a key, press the Shortcut field and press the desired key on your keyboard. It is possible to use a single key or a combination of keys such as ALT+D, for example.

When a report entry is made with the keyboard shortcut, the abbreviation of the type of indication displays momentarily on the corresponding Lissajous.

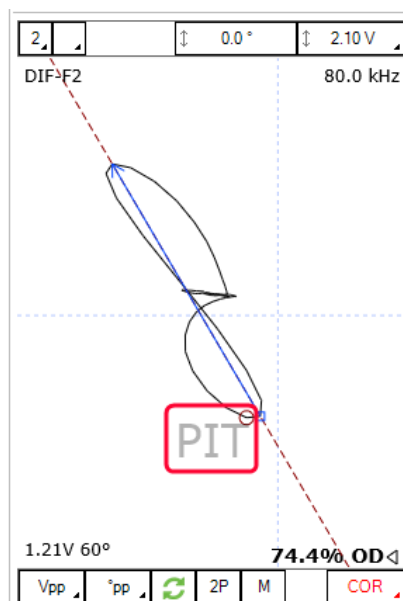

## DATA SCREENING

Data screening set up with the SMART Setup tools can be performed by the two buttons on the left under the Analysis tab.



It is possible to run analysis on a selection of files or all files. The analysis is typically performed on all files when the setup and calibration are adequate. The results are recorded in the logbook and can be viewed in the Data window.

## DATA LIST

Magnifi will save a file for each inspected tube. The file names are defined by creating a list of tubes.

This list can be created in the *Data List* section of the *General* tab of the *Backstage*.

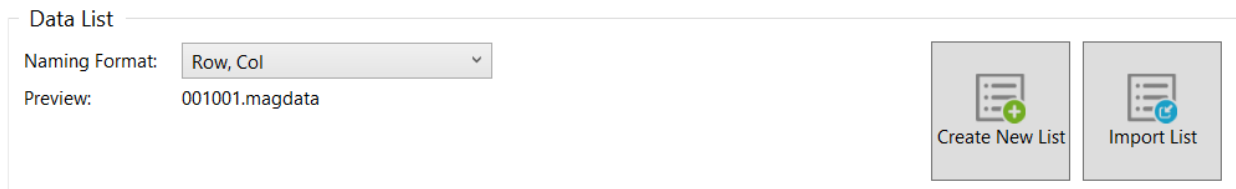

Four options are available to set the filename format:

- 1. Free format:**  
Each file has a custom name. Can also be defined from the Data tab of the Front Stage.
- 2. Prefix:**  
The file name includes a defined prefix followed by a sequential number.
- 3. Row, Col:**  
Row number, Column number. Mostly used for tubing inspections.
- 4. Zone, Row, Col:**  
Zone number, Row number, Column number. Mostly used for tubing inspections.

Click on the *Create New List* button. The displayed window will be different depending on the chosen filename format.

For the *Row, Col* option, enter the number of rows, the starting row number and row interval. You can then enter the number of tubes per row in the *Nb. of Columns* fields of the table. Click on *Create* to generate the list of tubes. You can also use the *Create & New* button to add another set of tubes to your list.

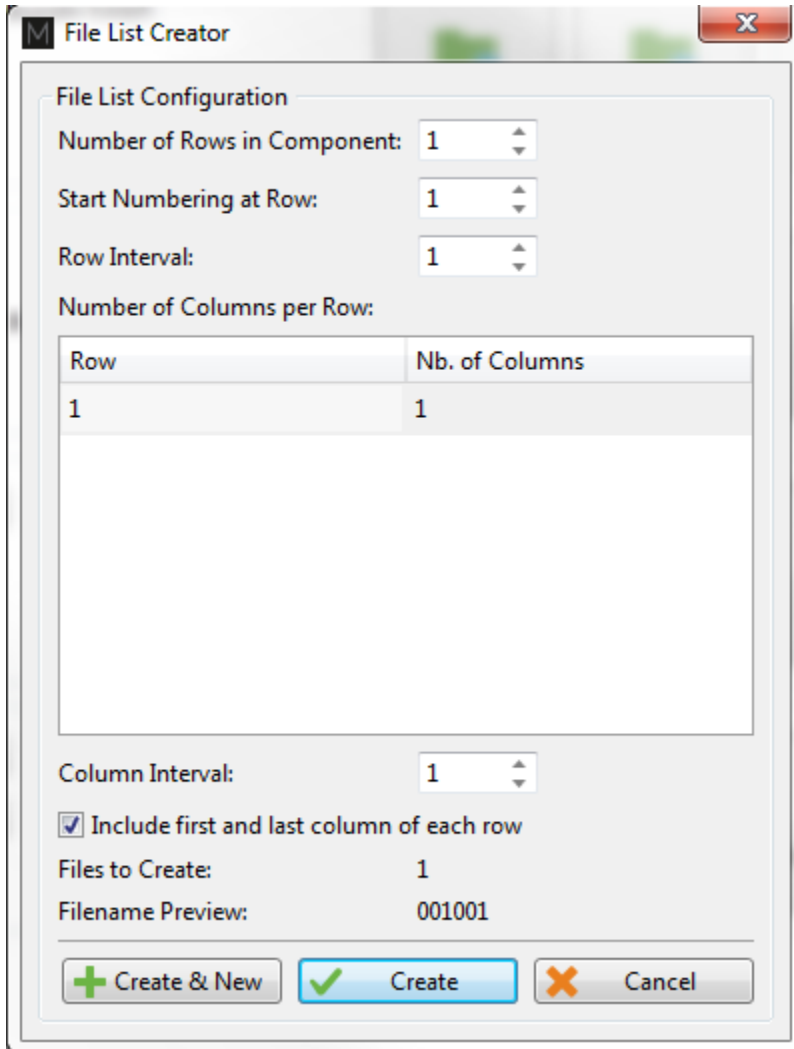

The same principles apply to the other file formats, except for the *Free format* option for which the file name(s) needs to be entered manually in the *Data* window of the *Frontstage*.

The tube list can also be imported from another project using the *Import List* button. The tube list file can be found in the *Inspection* folder. It is also possible to import a list created in the *TubePro* software (available from Eddyfi).

## PERFORMING AN ACQUISITION

1. If you are in the *Backstage*, move to the *Frontstage* by clicking on *Start/Resume* button.
2. Click on the *Connect* button under the *Instrument* tab. This will open the *Instrument configuration* page. Click on the line showing the instrument to which you want to connect and then click *Connect*.



Note: Your Ectane firmware version may not match the version of Magnifi you are using. If this is the case, a red and white X icon will be shown in the *Status* field of the *Instrument connection* window. To download a matching version to your Ectane, click on the *Config.* button and then click the *Send firmware to the instrument* button of the *Instrument configuration* window.

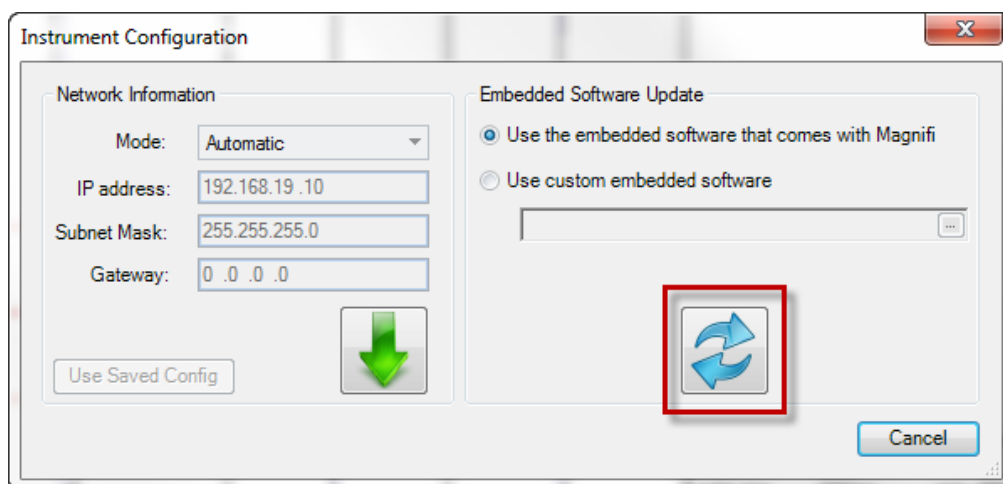
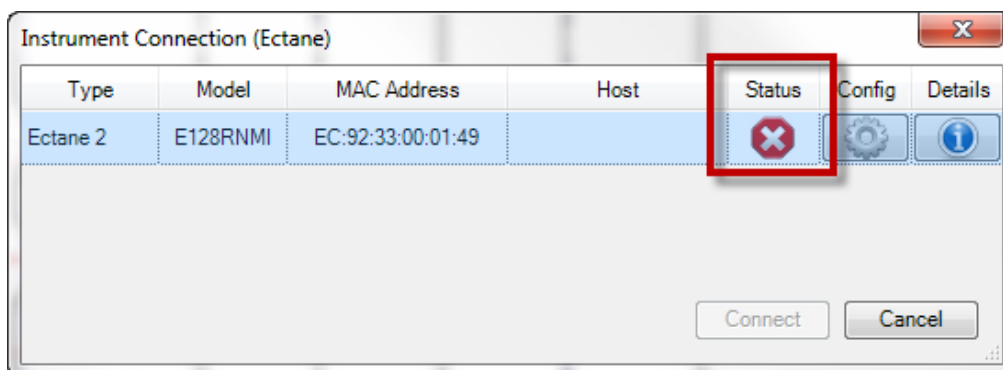

Two acquisition modes are available in Magnifi: *Setup Mode* and *Acquisition Mode*. *Setup Mode* is used to scan your calibration tube and make the necessary adjustments on your setup without saving the data

automatically. Acquisition mode is used for the inspection. In this mode, the software automatically saves the acquired data using file names based on the tube list.

3. For the calibration phase, go to *Setup Mode* by clicking on the *Setup Mode* button under the *Home* tab. This mode is active when the *Setup Mode* button is grayed.

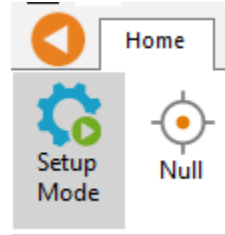

4. Plug the NFT probe on the Ectane 19-pin connector.
5. Bring the probe head in a clear area in your standard and balance the probe by clicking on the *Null* button under the *Home* tab, or press F6 on your keyboard.
6. Push the probe head all the way through the tube so that it exits the tube.
7. Start the acquisition by clicking on the *Acquire* button under the *Home* tab or by pressing the F2 on your keyboard.
8. Pull the probe at approximately 12"/s (300 mm/s).
9. When it's done, press the *Stop* button or F2 again on your keyboard.

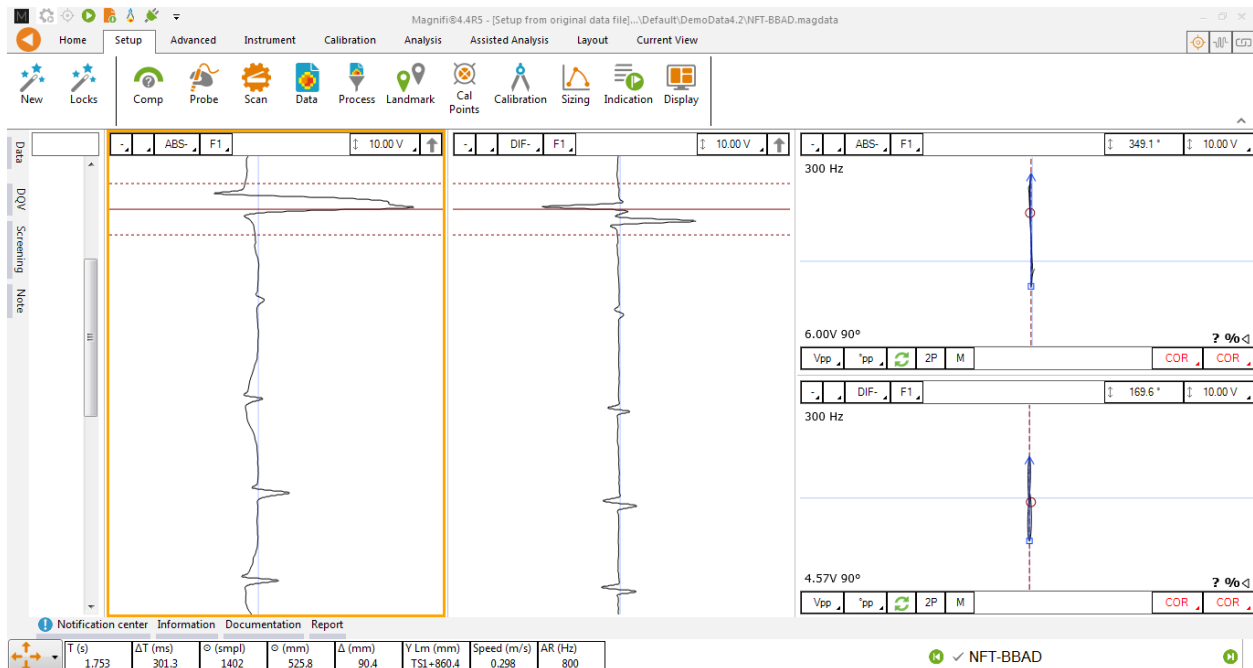

Note that a red zone in the code pane means that at least one of the raw signals is saturated. This is usually the case when your probe is out of the tube.

## VISUALIZING THE DATA

Multiple options are available to select your data and to measure it. The following describes useful functions to do so:

### DISPLAYED CHANNEL

There are four buttons at the upper right corner of the Strip charts and Lissajous windows. These buttons are used for the channel selection.

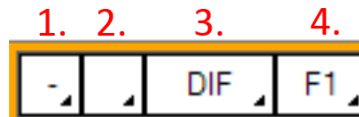

1. Links Strip charts and Lissajous to the same channel. For instance, if a Lissajous and a Strip chart are both set to 1, setting the Lissajous to DIF-F1 will also set the associated Strip chart to this channel.

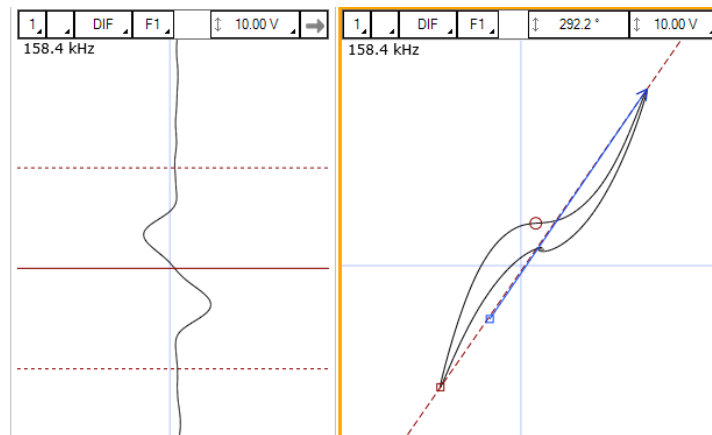

2. Clicking on the corner with the black triangle gives the list of available channels. Click on the desired channel to select it. Right-click or Left-click on this button to switch to the following or previous channel in the list.

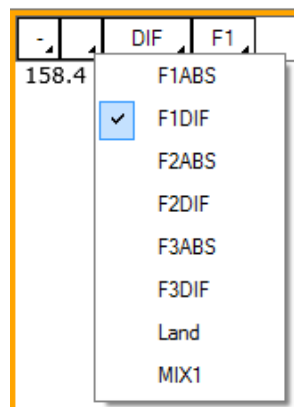

3. Same principle as 2., but for the type of channel only (absolute or differential).
4. Same principle as 2., but for the frequencies only.

## STRIP CHARTS AXIS ORIENTATION

The Strip charts are projections of the Lissajous on the vertical or horizontal axis. To switch from one axis to another, click on the box showing an arrow at the upper right corner of the Strip chart.



## ZOOMING

On the strip chart, hold the right button of your mouse and drag on the zone of interest to zoom in this section.

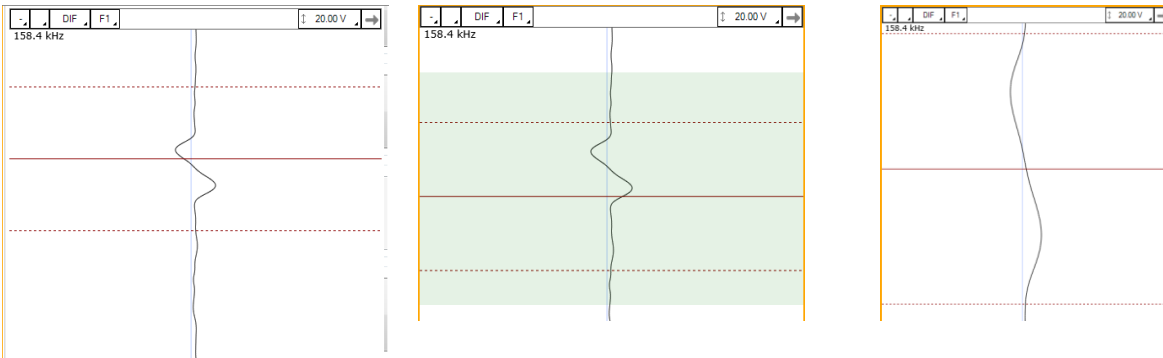

To zoom out, right-click on the Strip chart and select *Previous Zoom* or *Full Extent*.

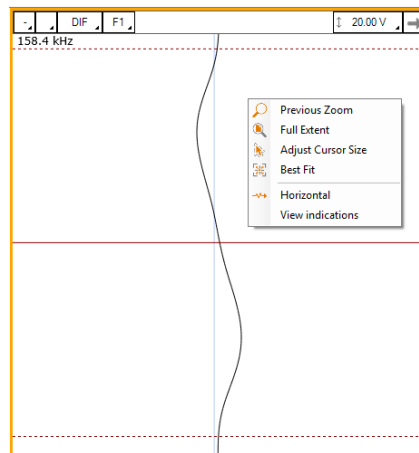

## ADJUSTING THE CURSOR LENGTH

On a Strip chart, the cursor is divided by 3 lines. The dotted lines represent the limit of your cursor and the full line is the center of what you have selected.

Only the portion of data between the dotted lines will be shown in the Lissajous.

To adjust your cursor length, hover your mouse over the dotted line, and click and drag the left mouse button. This will adjust the 2 dotted line symmetrically. To adjust only one dotted line, do the same operation, but with the right button of your mouse.

## ADJUSTING THE SCALE

The scale of a window (Lissajous or Strip chart) can be modified by clicking on the scale button with the left button (decrease scale) or the right button (increase scale) of your mouse.

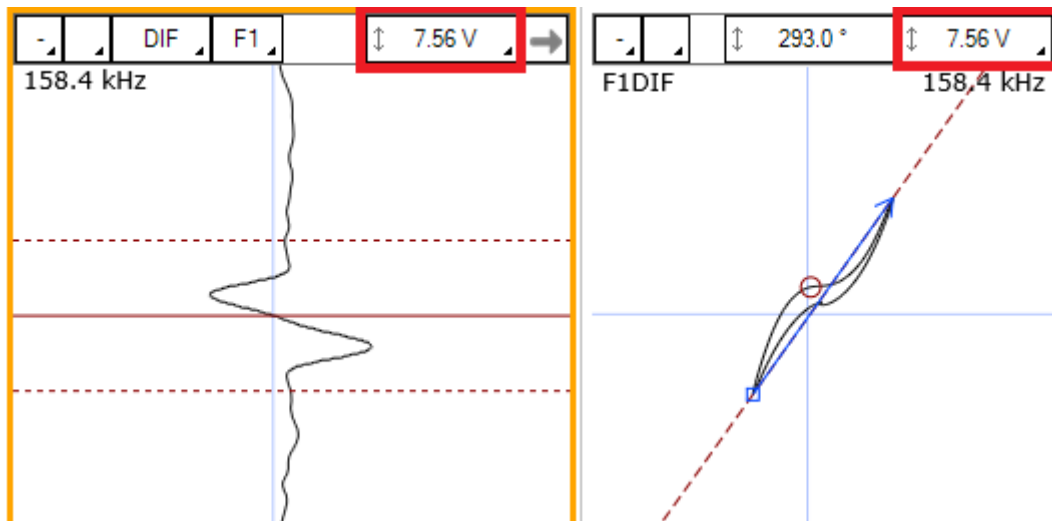

Another way to modify the scale is to click and drag (up or down) the right button of your mouse on the scale button.

## MEASUREMENT METHOD

The buttons at the lower left corner of the Lissajous windows are used to select the measurement method. A short description of the measurement methods can be found in the above calibration section of the setup wizard.



1. Clicking on the corner with the black triangle gives the list of measurement method for the amplitude of the signal. Click on the desired method to select it. Right- or left-click in this button to select the next or the previous method in the list.
2. Same as 1., but for the phase measurement



3. Remove 180° to the measured phase. This option can be used if the software doesn't measure the phase with the right orientation.
4. Take the same two points in time to take the measurement in the other Lissajous
5. Allow a manual measurement of the signal. Click and drag the left button of your mouse to draw a vector on your Lissajous.

## LISSAJOUS ROTATION AND PANNING

The signal in a Lissajous can be rotated by holding CTRL on the keyboard while holding the left button of your mouse and dragging it around the rotation axis. Note that this operation cannot be performed on the raw channels since these channels have no gain or rotated applied, by definition. Also, rotating the signal will affect your calibration. If you perform this operation, make sure to recalibrate afterwards.

The origin point can also be moved by holding the left button of your mouse on the Lissajous background and by dragging it in the desired direction.

## DATA CENTERING

To center the data in the different windows, put your cursor at a point where you want the data to be centered and use the spacebar on the keyboard.

## CALIBRATION AND SIZING CURVES

---

### CALIBRATION

The following section describes how to calibrate your probe.

1. Go to the *Calibration* tab and click on the *System* icon.
2. Select *Channel* in the *Calibration* window.
3. In the Strip chart, select the signal to calibrate and adjust the cursors to see only the desired signal.

Note: The system calibrates the signal with a measurement method that is defined in the calibration part of the setup (previous step). It is recommended to read the data with the same method as the system when you select your calibration point. This will allow you to see what the system is using to make its calibration. If for some reason the measurement is not taken properly, you may be able to readjust your cursor to have the right measured values.

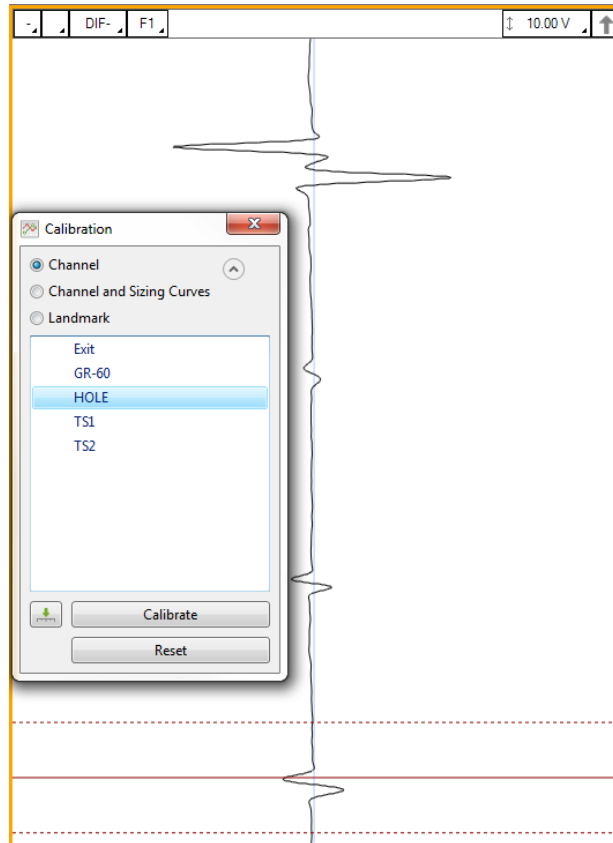

4. Select the signal name in the list.
5. Click on the green arrow button to associate the measured signal to the calibration point.
6. If more than one calibration point is present in the list, repeat steps 3, 4 and 5 for each one.
7. When all your calibration points are checked marked, click on the *Calibrate* button.

## SIZING CURVES

The following section describes how to build your sizing curves.

1. Go to the *Calibration* tab and click on the *Sizing curve* button.
2. Select *Channel and Sizing Curves* in the *Calibration* window.
3. Select the signal in your Strip chart and adjust the cursors to see only the desired signal.

Note: The system calibrates the signal with a measurement method that is defined in the calibration part of the setup (previous step). It is recommended to read the data with the same method as the system when you select your calibration point. This will allow you to see what the system is using to make its calibration. If for some reason the measurement is not taken properly, you may be able to readjust your cursor to have the right measured values.

Also, when points are entered in the sizing curves, the interpolated value is displayed on the Lissajous to show the defect size. To have the correct interpolated point, the measurement method also needs to be

the same as the one used for the sizing curve. To change the measurement method, click on the icons at the bottom left of the Lissajous.

4. Select the signal name in the list.
5. Click on the green arrow.
6. Redo the previous steps for all the other indications in the list.
7. Click on the Calibrate button.

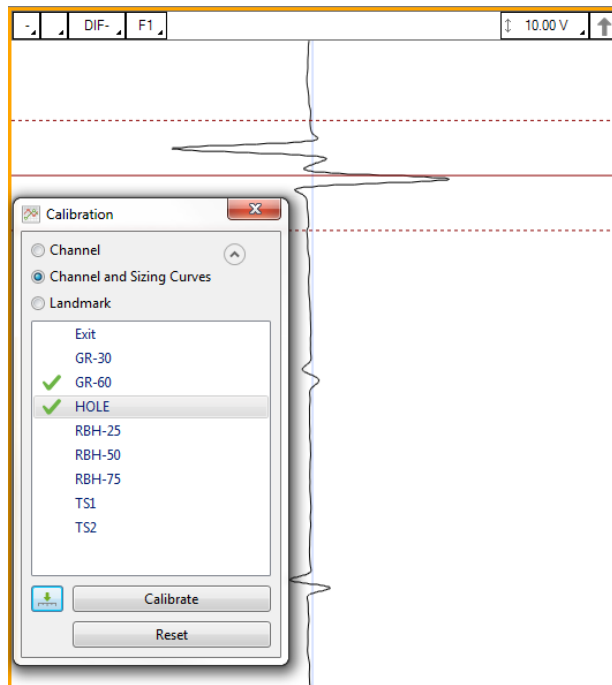

Sizing curves can also be adjusted manually. To do so, go to the *Calibration* tab, and click on *View Curves*. The sizing curve window will appear. Each sizing curve you asked Magnifi to create will be listed in the drop-down menu. If an invalid notification is present on the curve, it means that you either haven't entered the sizing points yet, or that Magnifi failed to create the curve. To adjust the sizing curve manually, enter the value in the table.

To validate the curves, you can bring the measurement cursor over one of the calibrated flaws in the Lissajous and get an estimation of the depth (shown in the lower right corner). If the flaw size does not appear, it means that you are not in a channel where a sizing curve was set.

## LANDMARKS

The following section describes how to calibrate your landmarks.

Go to the calibration tab and click on the Landmark icon. Calibrate the landmarks shown in the *Landmarks* window the same way you calibrated the sizing curve(s) points. You can use the *Land* channel to do so. The positions of TS1 and TS2 are described in the *Landmark* window in the *Setup* tab (TS2 is the farside

tubesheet, that is, the first one encountered by the probe during data acquisition; TS1 is the nearside tubesheet).

Once the landmarks are calibrated properly the system should be able to recognize them automatically.

Note that in order to calibrate the default *Exit* landmark, a datafile that includes the probe exit at the far end of the tube is needed.

## SAVING YOUR SETUP

Once all your setup adjustments are done, you can save your setup by clicking on the *Save Setup* button under the *Home* tab. The displayed window will allow you to give an appropriate name to your setup and to save it at the desired locations. The save location is, by default, your inspection file. Note that when a data is saved, the setup is also saved with it.

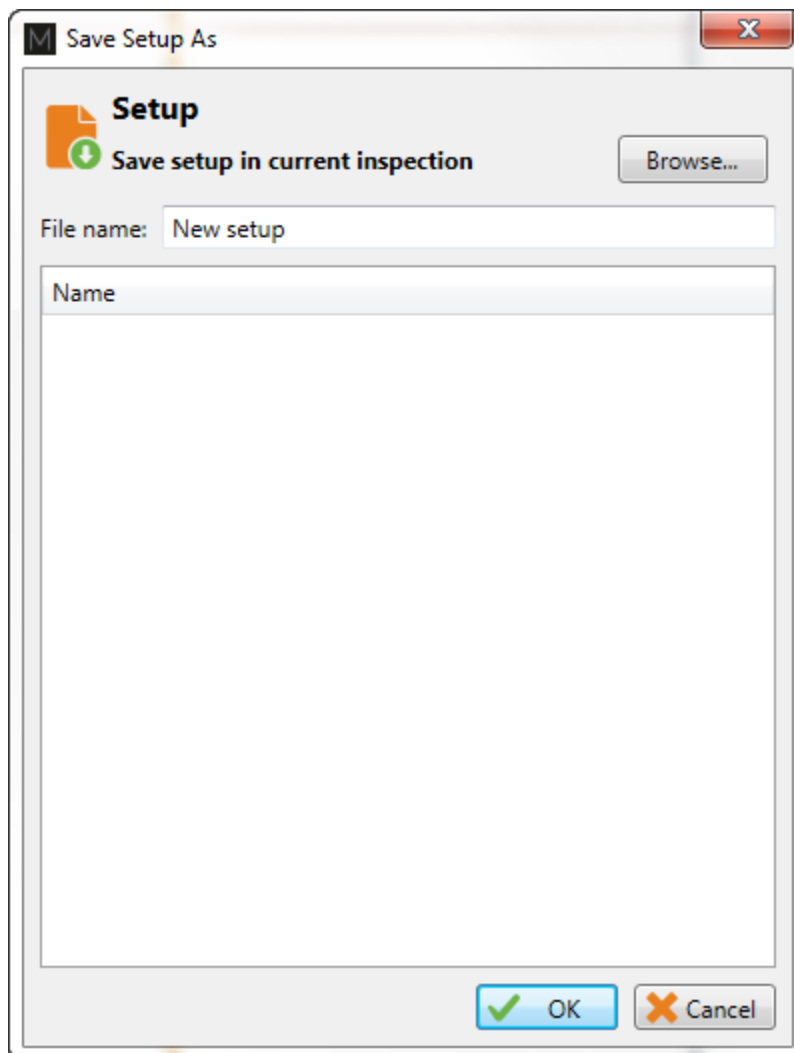

You can also save the data of your calibration standard by clicking on the *Save As* button under the *Home* tab.

### STANDARD ACQUISITION

The following section describes how to perform an inspection.

1. Connect Magnifi to your instrument.
2. Enter into *Acquisition Mode* by clicking on the *Setup Mode* button under the *Home* tab. *Acquisition Mode* is activated when the *Setup Mode* button is not grayed.
3. Plug the NFT probe into Ectane 19-pin connector.
4. Bring the probe head to a clear area in your standard and balance the probe by clicking on the *Null* button under the *Home* tab, or press F6 on your keyboard.
5. Push the probe all the way through the tube until it exits the far end.
6. Start the acquisition by clicking on the *Acquire* button under the *Home* tab or by pressing the F2 on your keyboard.
7. Pull the probe towards you at a constant speed until it exits the tube.
8. When finished, press the *Stop* button or again F2 on your keyboard.
9. Repeat steps 4,5,6 and 7 for all the tubes to inspect in your bundle.

### MANUAL SEQUENCE

An inspection can also be done by using the manual sequence. This feature is based on the landmarks and can trigger the acquisition start/stop and the data recording automatically. At least two landmarks are needed to use this feature. These landmarks can be created by using the Landmarks button under the SMART Setup tab.

To set the manual sequence:

1. Click on the *Manual Sequence* button under the *Calibration* tab.
2. If a warning message is shown in this window, change the parameters until no warning is shown. The system will progress through the different windows to guide you.
3. Click on *Settings ...*

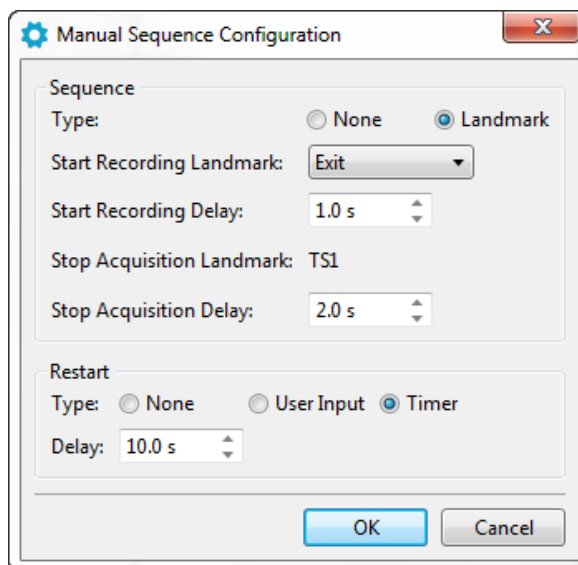
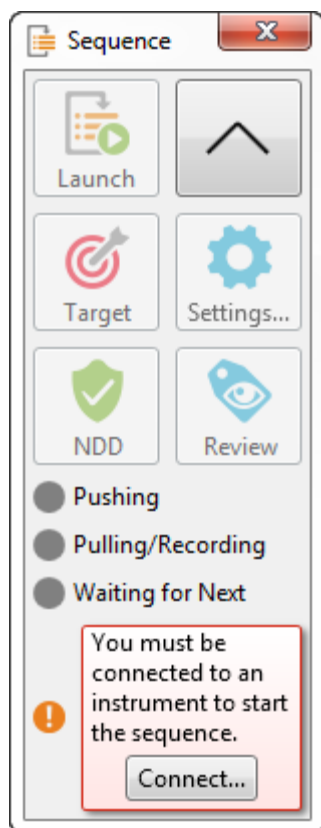

4. Select *Landmark* in the *Type* section
5. In the drop-down menu choose the Landmark that will initiate the data recording. If you keep the default landmarks, you can select the *Exit* landmark that will be triggered when the probe goes out of the tube when the probe is pushed.
6. You can enter a delay to start the acquisition after the first landmark is detected (*Start Recording Delay*) and a delay to stop the acquisition when the last landmark is detected (*Stop Acquisition Delay*).
7. Two options are available to restart the acquisition: The user can either push a button or use a timer. Select the desired option in the *Restart* section.
8. Click on *OK*.

To use the manual sequence:

1. Connect Magnifi to the instrument
2. Enter into *Acquisition Mode* by clicking on the *Setup Mode* button under the *Home* tab. *Acquisition Mode* is activated when the *Setup Mode* button is not grayed.
3. Plug the NFT probe into the Ectane 19-pin connector.
4. Bring the probe head to a clear area in your standard and balance the probe by clicking on the *Null* button under the *Home* tab, or press F6 on your keyboard.
5. Open the *Sequence* window by clicking on the *Manual Sequence* button under the *Calibration* tab.
6. Put your probe in the tube to inspect and click on the *Launch* button. This will start the data acquisition.

7. Push the probe out of the tube. If set correctly, this will trigger the landmark that will start the data recording.
8. Pull the probe until it exits the far end of the tube. If set correctly, Magnifi will recognize the landmark and this will initiate the data recording.
9. Acquisition restart:
  - a. If you selected *User Input* in the settings of the *Manual Sequence Configuration*, the system will wait for the user to enter information on the tube to restart the acquisition. Click on *NDD* or *Review*. This will add a tag to the inspected tube and it will restart the acquisition. Repeat steps 6, 7 and 8. for all the tubes to inspect.
  - b. If you selected *Timer* in the settings of the *Manual Sequence Configuration*, a *countdown will trigger after the last tube acquisition was taken*. The acquisition will start after this time has elapsed. Redo step 6 and 7 for all the other tubes to inspect in the bundle.

When doing your inspection, you may encounter some tubes that can't be scanned completely. If this is the case, you won't be able to catch the landmark that trigs the data recording at the end of the tube. In this situation, you can click on the *Target* button in the *Sequence* window to start the data recording.

## DATA LIST MANAGEMENT

For each acquisition, Magnifi can automatically save a file using the file name defined previously in the *Tube list* section of this document. To do so, checkmark the *Automatic File Recording* option that can be found under the *General tab* of the *Preference* menu of the *Backstage*.

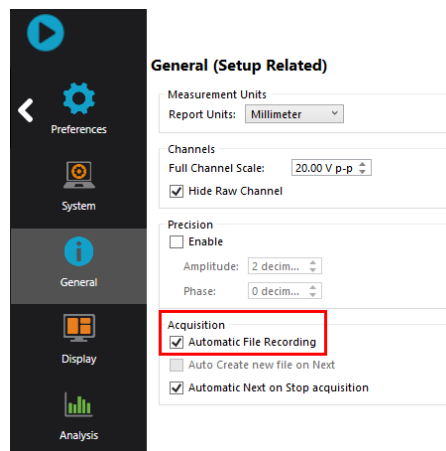

The list of tubes is also shown in the *Data* window.

Row	Col	Icon
✓	101000001	20 (8) X
✓	101000002	9 (8) X
✓	101000003	10 (8) X
✓	101001001	16 (8) ✓
✓	101001002	9 (8) ✓
✓	101002001	11 (8) ✓
✓	101002010	14 (8) ✓
✓	101004005	15 (8) ✓

A common practice is to rescan your calibration tube and balance the probe periodically. You can save this new calibration tube data by adding a new tube in your tube list (999 001 for example). Or you can go out of acquisition mode, scan your tube, and click on the *Save Cal As...* button under the *Calibration* tab to save your data. You can then go back to *acquisition mode* to continue your inspection and to automatically save the acquired tubes in your bundle.

Once a tube has been scanned, the "play" icon next to the file name will be replaced with a checkmark icon.

You can rescan a tube by selecting its name in the list and by clicking on the *Rescan* button in the *Home* tab.

A tube name can be changed by right-clicking on its name and by selecting the *Rename* option.



## LOADING A FILE

1. First disconnect your computer to the Ectane by clicking on the *Disconnect* button under the *Home* tab
2. You can load a file by double-clicking on the file name in the *Data* window. It can also be done by selecting the file in the list and by clicking on the *Load* button under the *Home* tab. Note that double-clicking on a tube when you are still connected to an instrument will initiate data acquisition.
3. You can open the next or the previous file in the list by clicking on the *Previous* or *Next* button of the *Home* tab.

The data files can be filtered by using the *Filter* button of the *Data* window.

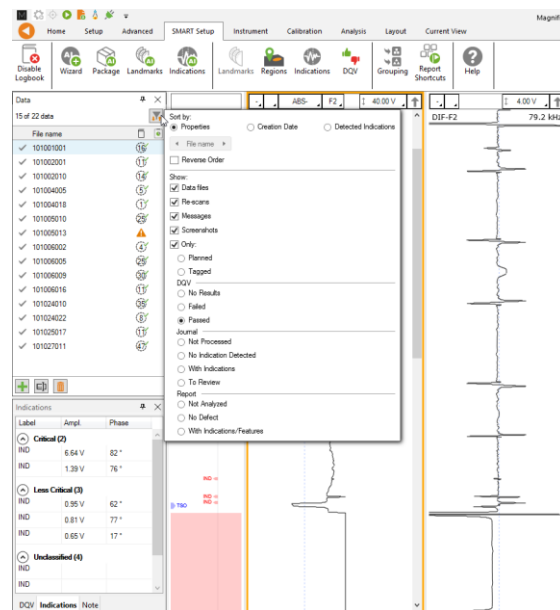

## REPORT

### INDICATIONS

The two *Indication* buttons at the lower corner of the Lissajous windows can be used to add an entry to the report. These two buttons indicate the code that is associated with the defect being entered. Both buttons are identical, but can be set to identify different flaws.

To add an indication to the data:

1. Select the defect signal in the strip chart and adjust the cursor so that the signal in the Lissajous includes only the defect signal.
2. Then, click on the red triangle in the corner of the *Indication* button to select the type of defect to enter.
3. Click on the defect button to add an entry to the report.

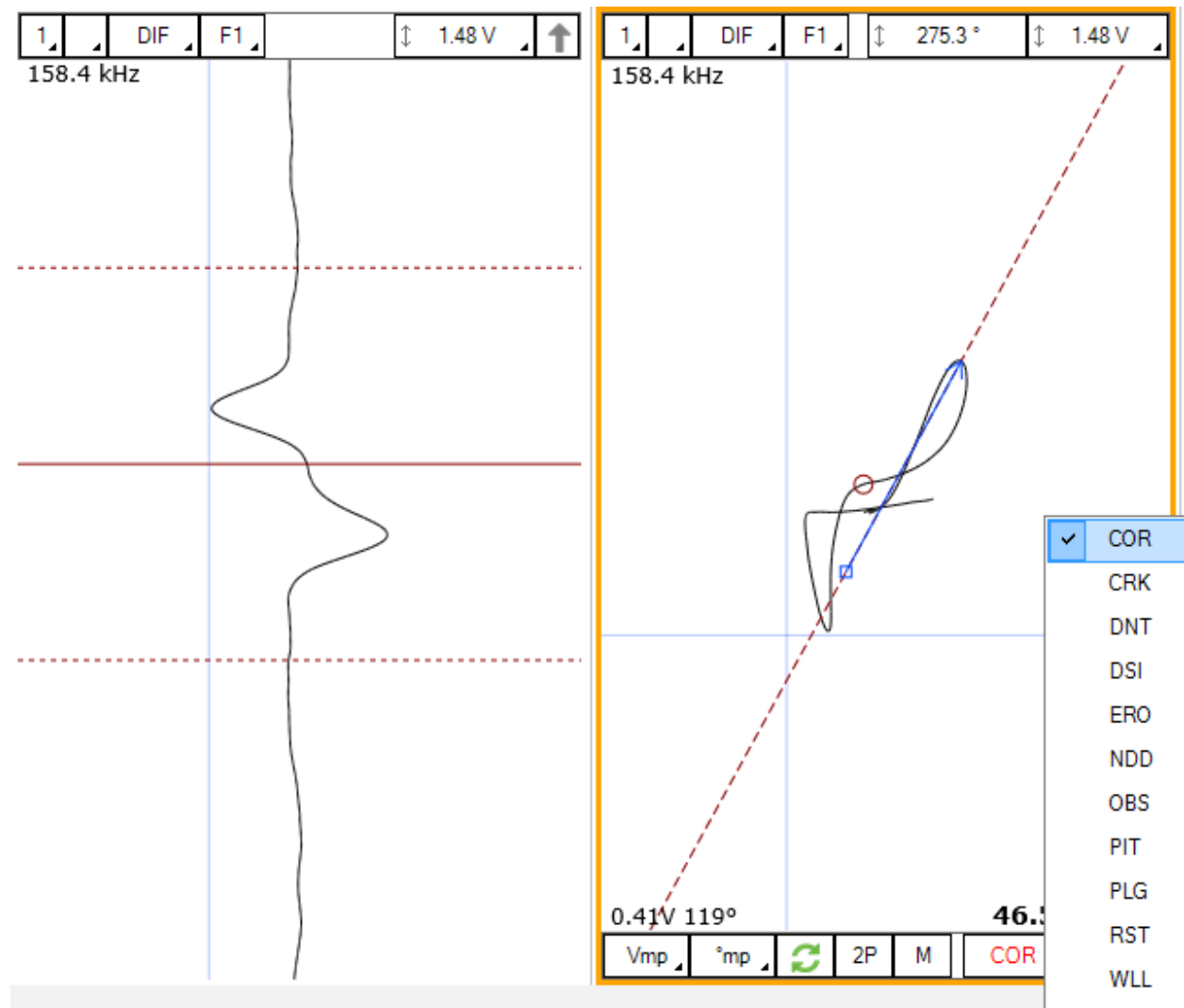

Report Entries can also be added with keyboard shortcuts. How to set up these keyboard shortcuts is explained in the SMART Setup section of this manual.

Indications can also be added to a tube to indicate, for instance, that it has no flaw or that it is plugged.

To add an indication to a tube:

1. Load the file
2. Click on the appropriate indication button available under the Analysis tab

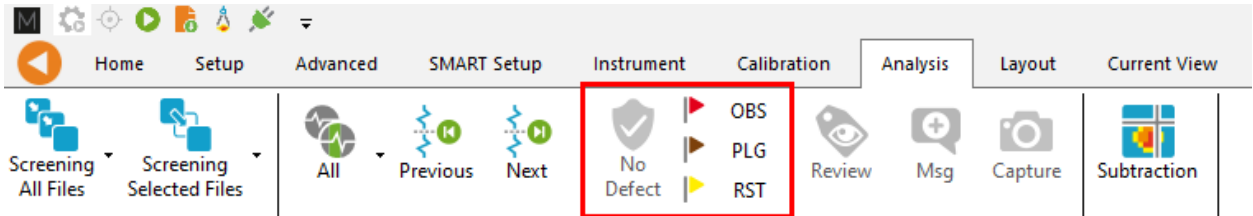

## REPORT TABLE

To access the list of indications entered:

1. Make sure that the Report option is selected under the Layout tab.

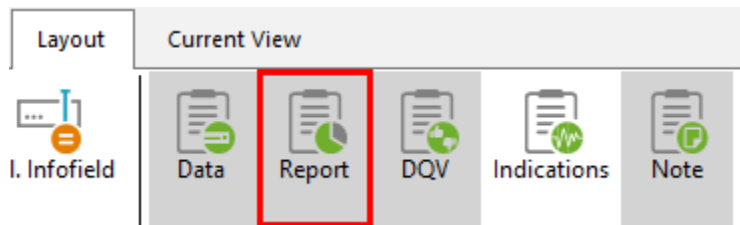

2. Click on the report ribbon at the bottom of the screen to make the list visible.

Zone	Row	Col.	Code	Size	Side	Ampl. (V)	Angle (°)	Channel/C-scan	Y pos. (mm)	LMK Y pos.	Offset Y pos. (mm)	Y leng. (mm)	Comment
1	0	0		0.00		0.00	0		0.0		0.0	0.0	X
2	0	0		0.00		0.00	0		0.0		0.0	0.0	X

At the bottom of the window, there is a status bar with a notification icon and the text '2 new notifications Information Report'. The 'Report' button in the status bar is highlighted with a red box.

Entries in the report can be modified by changing the value in the table. You can also delete an entry by clicking on the X next to it.

## REPORT GENERATION

Magnifi can automatically generate a full report with the report table.

To generate this report:

1. Go to the *Backstage* by clicking on the arrow at the upper left corner of the *Frontstage*.

- Click on the *Generate Report* button under the *Report* section of the *General* tab.
- Choose your preferences and enter the required parameters. The *# of tubes in component* is used to show the percentage of tube in each category.

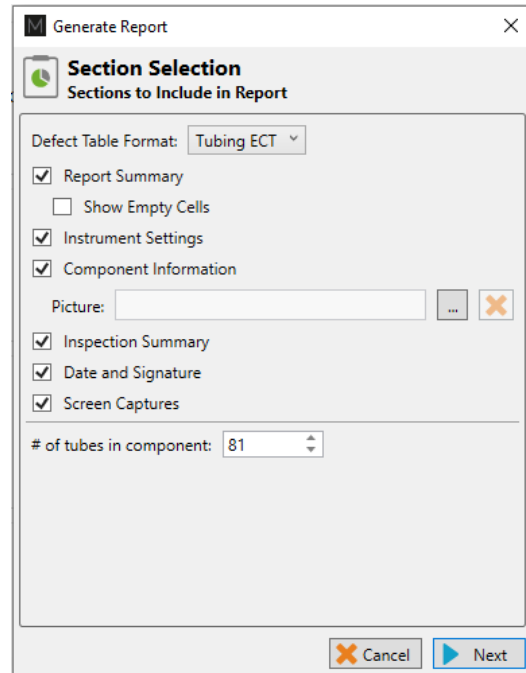
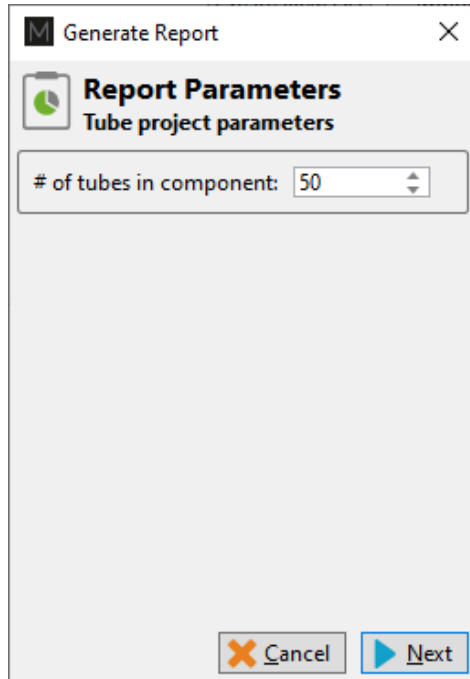

- Click Finish to generate the report.

Once generated, the report is saved as a .html file in the current Inspection sub-directory. It can be viewed using any regular web browser.

There is a “copy” button next to each element of the report such as tables and images. When clicking on it, the element will be copied to the clipboard. It can then be pasted to another file such as an Excel or Word.

Name	Frequency (KHz)	Drive (V)	Gain (dB)	Low Pass (KHz)	High Pass (Cnt)
R_ABS-F1	160.0	2.50	46.0	400	
R_ABS-F2	80.0	2.50	46.0	400	
R_ABS-F3	40.0	2.50	46.0	400	
R_ABS-F4	20.0	2.50	46.0	400	
R_DIF-F1	160.0	2.50	46.0	400	
R_DIF-F2	80.0	2.50	46.0	400	
R_DIF-F3	40.0	2.50	46.0	400	
R_DIF-F4	20.0	2.50	46.0	400	

The Print button, bottom right corner on image above, can be used to either print a paper copy of the whole report or to save it as a .pdf document. The PDF generator available with the current web browser will be used.

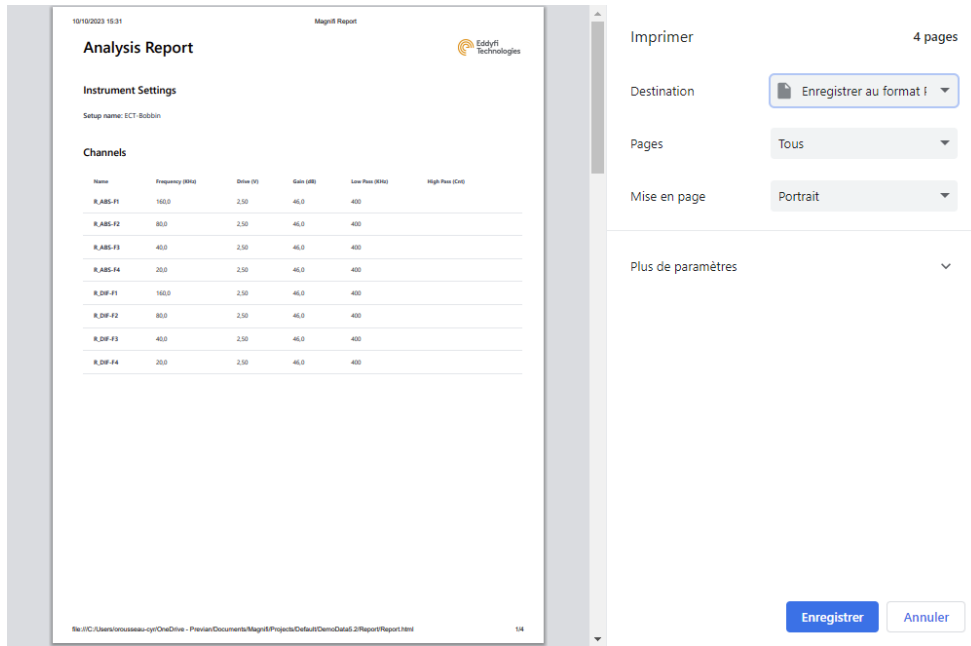

The report logo can be modified by clicking on the *Select Company Logo* that can be found under the *System* tab of the *Backstage*.

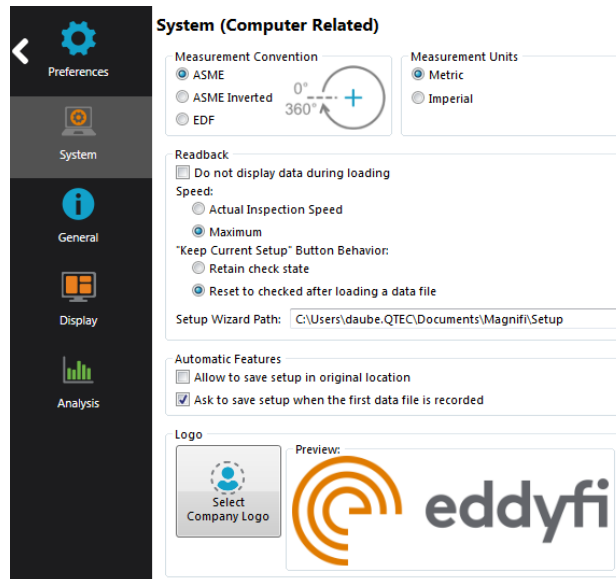

The report table file in the *Inspection* folder can also be imported into other reporting software such as *TubePro*.

# NFA Application Guide

## NFA Probes



## INTRODUCTION

This procedure presents how to use an NFA probe with Magnifi and above on an Ectane test instrument.

## EQUIPMENT

The NFA probes use a 160-pin connector that can be connected to an Ectane with the “E64” option.

The array section of the probe will provide a C-scan imaging and the conventional channel will display a standard Strip chart / impedance plane signal for the absolute.

From the following table, the best probe for your application can be selected.

TUBE OD		TUBE WT			DIAMETER			FREQ.		POLY		PROBE PART NUMBER
mm	in	BWG	mm	in	CODE	mm	in	CODE	RANGE	CODE	LENGTH	
19.05	0.750	12	2.77	0.109	124	12.4	0.488					PRBT-NFA-BBAA-124MF-Nzz
		13	2.41	0.095	130	13.0	0.512					PRBT-NFA-BBAA-130MF-Nzz
		14	2.11	0.083	138	13.8	0.543					PRBT-NFA-BBAA-138MF-Nzz
		15	1.83	0.072	142	14.2	0.559					PRBT-NFA-BBAA-142MF-Nzz
25.40	1.000	10	3.40	0.134	170	17.0	0.669					PRBT-NFA-BBAA-170MF-Nzz
		11	3.05	0.120	180	18.0	0.709					PRBT-NFA-BBAA-180MF-Nzz
		12	2.77	0.109	184	18.4	0.724					PRBT-NFA-BBAA-184MF-Nzz
		13	2.41	0.095	188	18.8	0.740					PRBT-NFA-BBAA-188MF-Nzz
		14	2.11	0.083	194	19.4	0.764	MF	1-40kHz	20	20 m (65 ft)	PRBT-NFA-BBAA-194MF-Nzz
31.75	1.250	15	1.83	0.072	200	20.0	0.787			30	30 m (98 ft)	PRBT-NFA-BBAA-200MF-Nzz
		10	3.40	0.134	230	23.0	0.906					PRBT-NFA-BBAA-230MF-Nzz
		11	3.05	0.120	236	23.6	0.929					PRBT-NFA-BBAA-236MF-Nzz
		12	2.77	0.109	244	24.4	0.961					PRBT-NFA-BBAA-244MF-Nzz
		13	2.41	0.095	250	25.0	0.984					PRBT-NFA-BBAA-250MF-Nzz
38.10	1.500	10	3.40	0.134	290	29.0	1.142					PRBT-NFA-BBAA-290MF-Nzz
		11	3.05	0.120	296	29.6	1.165					PRBT-NFA-BBAA-296MF-Nzz
		12	2.77	0.109	302	30.2	1.189					PRBT-NFA-BBAA-302MF-Nzz
		13	2.41	0.095	308	30.8	1.212					PRBT-NFA-BBAA-308MF-Nzz

The NFA calibration tube used in this document includes the following flaws:

- Internal taper groove, 30% of wall loss on 4in length
- ID Round bottom hole 50% of wall loss, Diameter 0,138in
- ID Round bottom hole 50% of wall loss, Diameter 0,186in
- ID Round bottom hole 50% of wall loss, Diameter 0,375in
- ID Round bottom hole 50% of wall loss, Diameter 0,250in
- ID Round bottom hole 50% of wall loss, Diameter 0,312in
- Internal Groove 20 %

Other combinations of flaws can be used to calibrate the probe and to build sizing curves.



## PROJECT AND INSPECTION FILES

---

In this section, we will create a folder structure that will manage the saving location of your setup, data and report. This management is operated through the creation of a *Project*.

Magnifi suggests two levels of file. The first level is the *Project*. It is meant to include different inspections that are related in some way. For instance, it can include all the inspections done at a refinery shutdown and be named *Refinery\_Shutdown\_May\_2018*. The second level of the file is the *Inspection* folder. Inspection folders are saved in the project file. An inspection folder can include the data specific to the inspection of a tube bundle with a specific technology and could be named *SS316\_075x0.065\_ECT* for instance. This inspection folder groups the setup, the tube list, the data files and the Magnifi report.

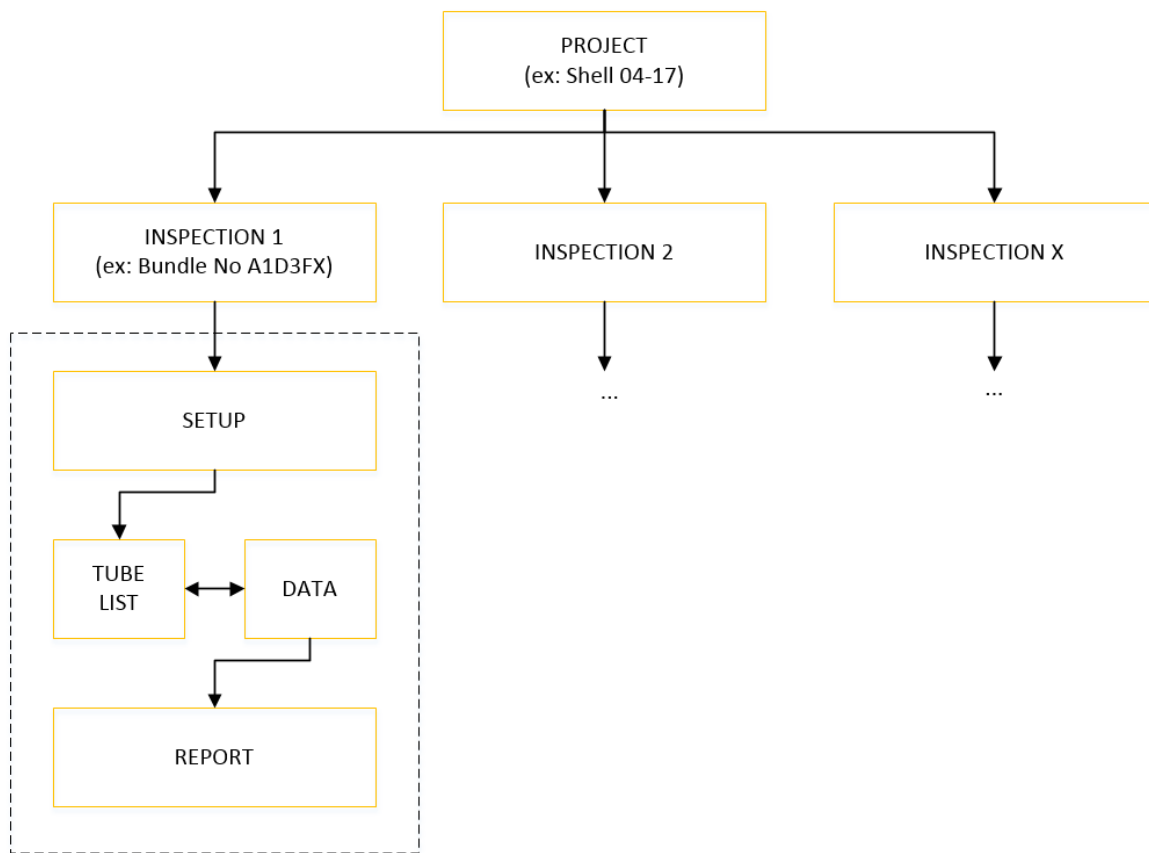

When you open Magnifi, the first page displayed is called the *Backstage*.

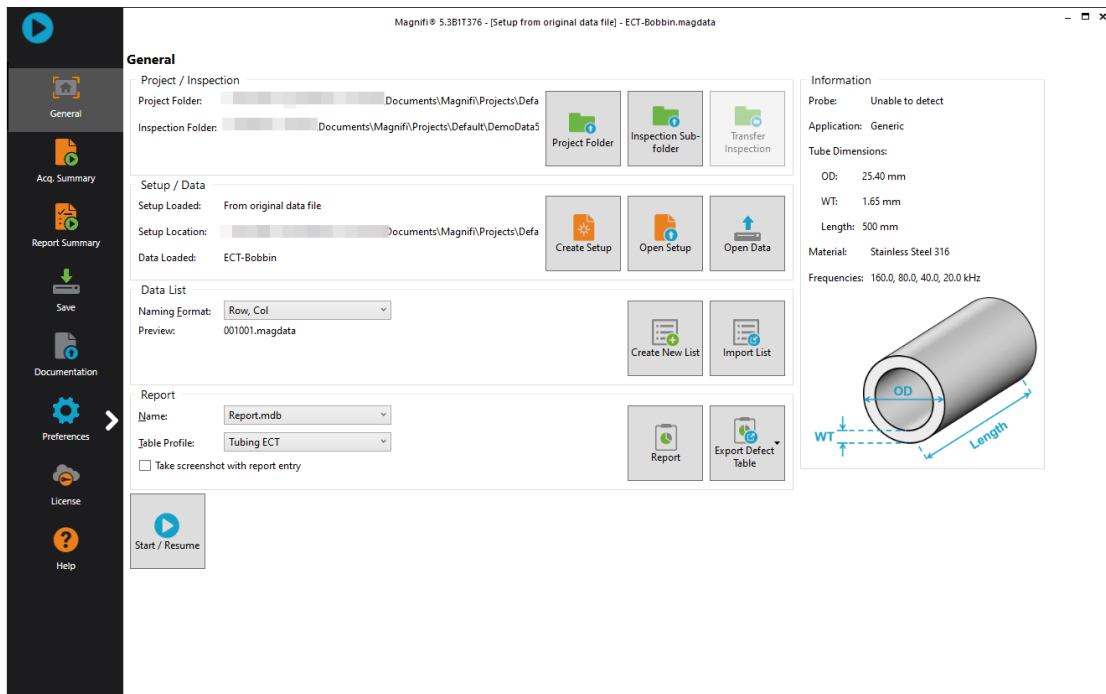

To create or open a project, click on *Open/Add Project* in the backstage. You can select an existing project/folder, or you can create a new folder.

1. Create a folder by right-clicking on the location where you want to add your Project file. Select *New, Folder* and enter the chosen name. You can then select the newly created folder and click on *Select Folder*.

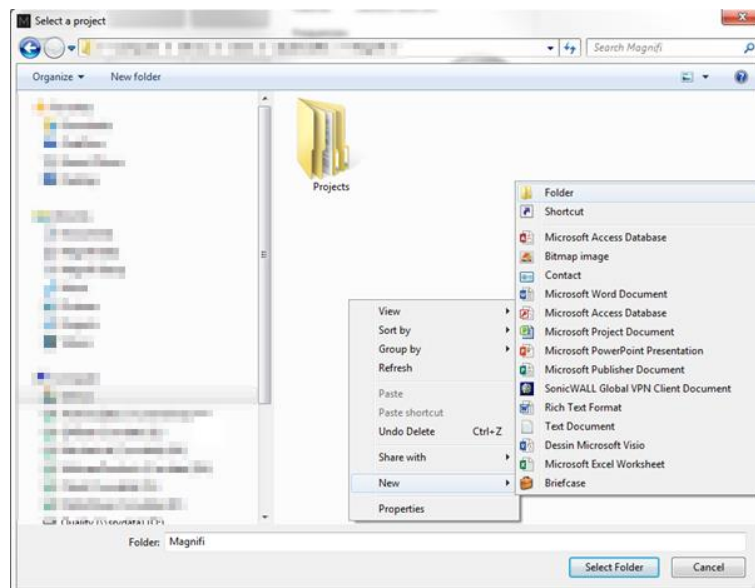

Click on *Add/Open Inspection* in the backstage, then click on *Add* and enter the name of your inspection.

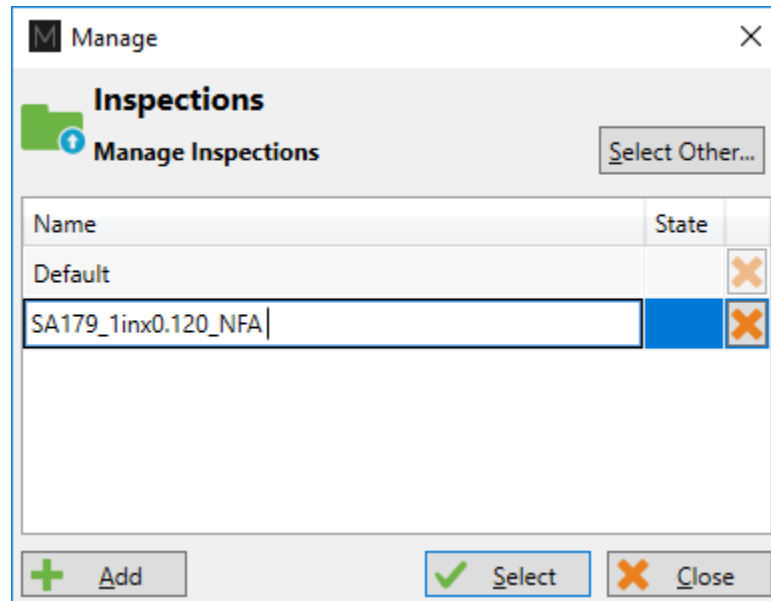

2. Click *Select*. This will define the position where the setup(s) and data will be saved.

## SETUP WIZARD

In this section, we will show how to create a setup using the *New Setup Wizard* in Magnifi.

Before going further, you can change the measurement unit. To do so, click on *Preferences*. In the *System* tab, you can change the measurement units from metric to imperial and vice versa. For the metric units, you can choose to use meters, centimeters, or millimeters in the *General* tab. inchesThe default measurement for imperial units is inches. When finished, click on *Preferences* again to go back to the *General* window.

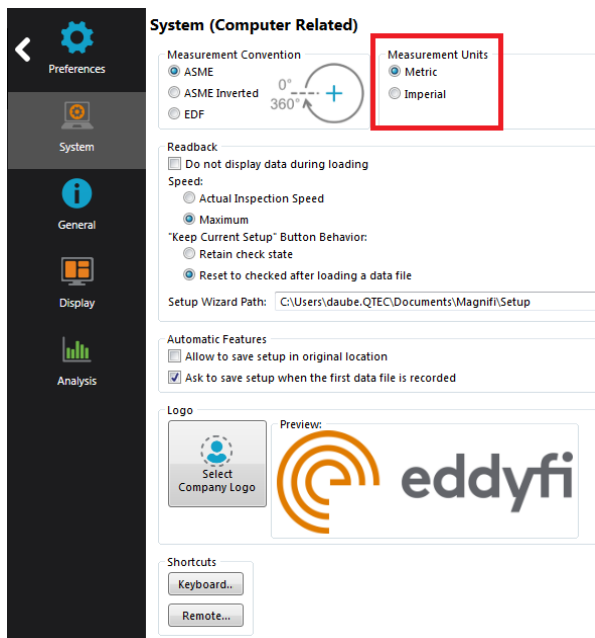

To create a new setup, it's strongly suggested to use the Wizard option menu. Click on *Create Setup* to start the Wizard.

## COMPONENT DEFINITION

The first page shown by the Wizard is the Component Definition.

Click on the Material field to open the drop-down menu. Select the material of the tube to be inspected. If the material is not in the list, you can click on Manage... to open the List of Available Material window.

**New Setup Wizard** ×

### Component Definition

Configure the geometry and material of the component to inspect

**Geometry:**  Surface  Tube from ID

**Application:**  Generic  Air Conditioner

**Material:** Carbon steel

Resistivity: 21  $\mu\Omega\cdot\text{cm}$   
Permeability: 450  $\mu$   
Velocity: 5890.000 m/s

**Wall thickness:** 3.05

BWG: 6 11 24

**Outside diameter:** 25.40 mm

**Length:** 6000 mm

Note about selected material:  
ASTM: A178, A179, A192, A210, A214

To add a new material to the list, click on *Add*. A new line will appear in the list. Give the material a relevant name and set the material resistivity and permeability to its theoretical value. The ultrasound velocity is used to set IRIS parameters only, and it doesn't need to be set if an IRIS inspection is not performed on this material.

It's possible to add a note about the material to specify information such as its application or composition. When you are done, click *OK*.

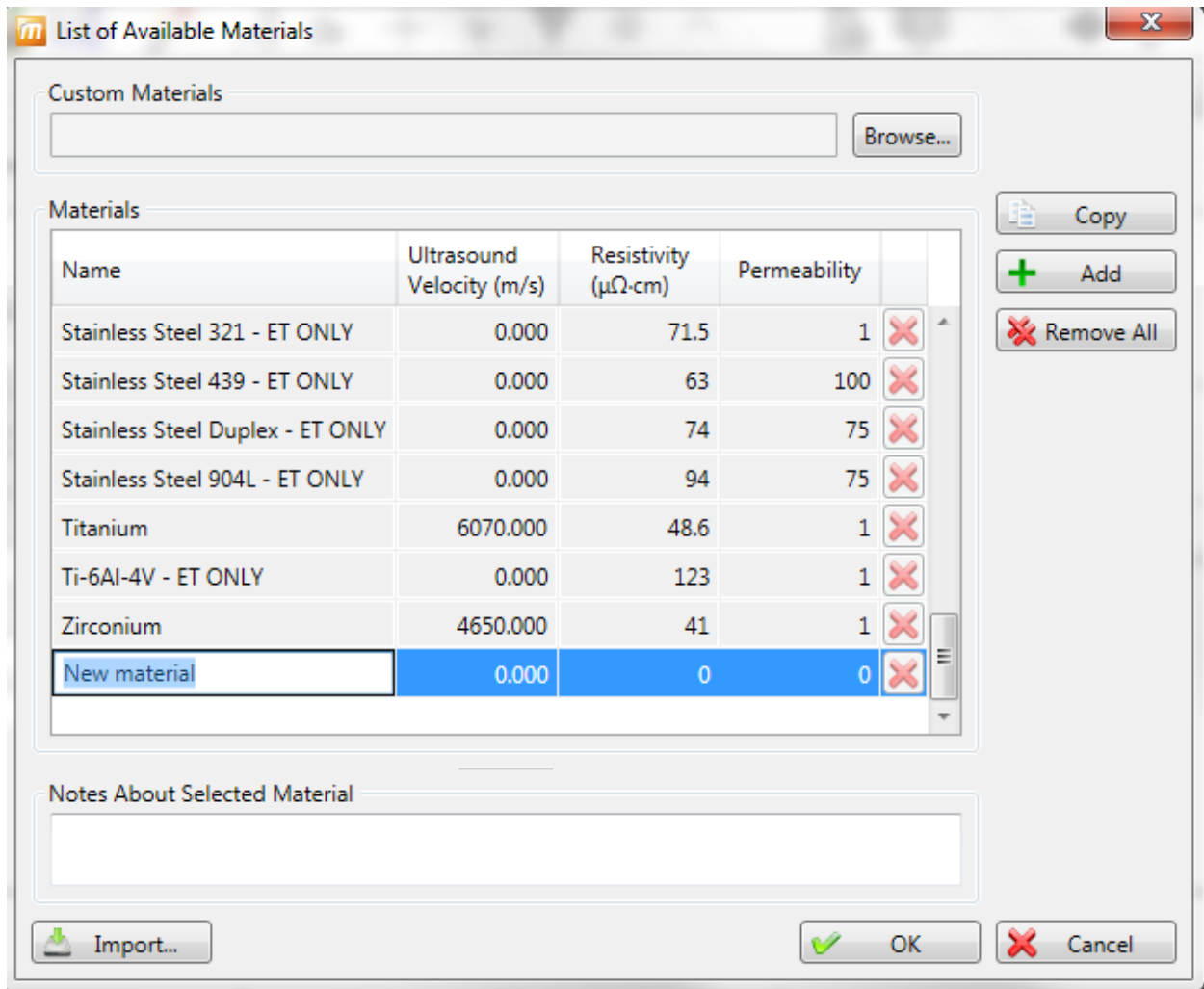

You will be back to the *Component Definition* window. If you added a new material, it will now be available in the material list.

Adjust the tube wall thickness by entering the value in the *Wall thickness* field or by moving the slider. Enter the tube's outer diameter and length.

These tube properties will help Magnify to suggest the optimal scan parameters.

Click *Next* when everything is set correctly.

## PROBE SELECTION

In the *Probe Selection* window, you must select the probe you will be using for your inspection.

You can filter the probe list by choosing an inspection technique from the *Technique*: drop-down menu. More precise filtering can be done by using the *Model* drop-down menu. You can then select your probe by its catalog number (PRBT-NFA-BBAA) and then click *Next*.

**Probes**

Tech.	Model	Catalog Number	Description
NFT	NFA	PRBT-NFA-BBAA-130MF	NFA probe, ABS with array receivers (2x9), diameter 13.0 mm, MF frequency range.
NFT	NFA	PRBT-NFA-BBAA-138MF	NFA probe, ABS with array receivers (2x9), diameter 13.8 mm, MF frequency range.
NFT	NFA	PRBT-NFA-BBAA-142MF	NFA probe, ABS with array receivers (2x10), diameter 14.2 mm, MF frequency range.
NFT	NFA	PRBT-NFA-BBAA-162MF	NFA probe, ABS with array receivers (2x12), diameter 16.2 mm, MF frequency range.
NFT	NFA	PRBT-NFA-BBAA-170MF	NFA probe, ABS with array receivers (2x13), diameter 17.0 mm, MF frequency range.
NFT	NFA	PRBT-NFA-BBAA-180MF	NFA probe, ABS with array receivers (2x14), diameter 18.0 mm, MF frequency range.
NFT	NFA	PRBT-NFA-BBAA-184MF	NFA probe, ABS with array receivers (2x14), diameter 18.4 mm, MF frequency range.
NFT	NFA	PRBT-NFA-BBAA-188MF	NFA probe, ABS with array receivers (2x14), diameter 18.8 mm, MF frequency range.
NFT	NFA	PRBT-NFA-BBAA-194MF	NFA probe, ABS with array receivers (2x15), diameter 19.4 mm, MF frequency range.
NFT	NFA	PRBT-NFA-BBAA-200MF	NFA probe, ABS with array receivers (2x15), diameter 20.0 mm, MF frequency range.

New... Manage...

Cancel Back Next

## SCAN DEFINITION

The *Scan Definition* window is used to configure the axial position measurement method, the acquisition rate and the typical probe speed.

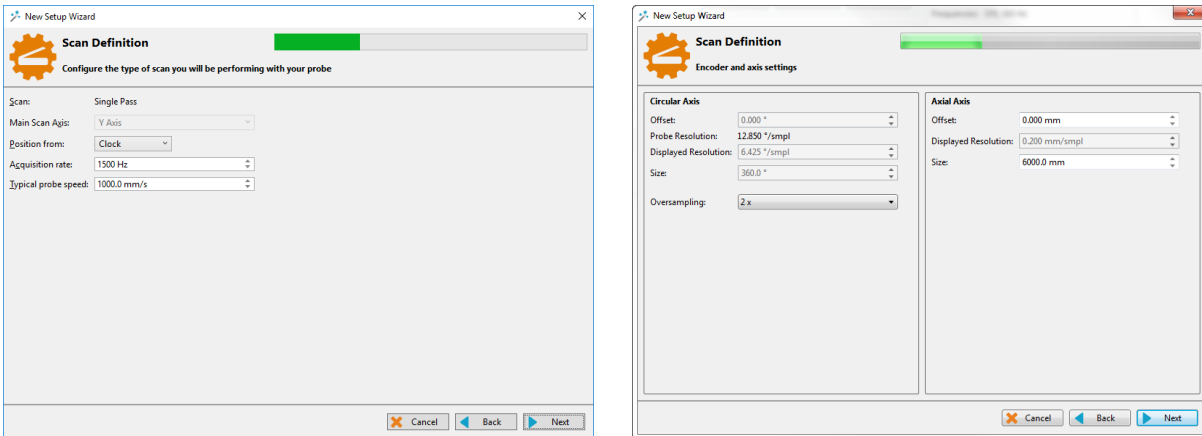

The position along the tube can be defined by using either the internal clock of the system, or by using an axial encoder. If you use the internal clock, the default position will be given assuming that the probe is always pulled at the typical probe speed. If the typical probe speed is set to 300mm/s, and the time since the acquisition began was 2 seconds, then the system will indicate a position of 600mm. Using an encoder will give you the exact position of the probe. Note that the position can also be obtained by using the landmark tool, but this feature will be shown later.

The acquisition rate is the number of acquisition points taken per second. By default, the acquisition rate is set to 1500 Hz for NFA.

The axial resolution will depend on the combination of the acquisition rate and pulling speed. For instance, with an acquisition rate of 2000 Hz, the pulling speed needs to be less than 1m/s to have at least 2 points per millimeter. If you do not use a pusher-puller device such as the Probot, the pulling speed won't be constant. Therefore, it is recommended to target a lower pulling speed to be able to reach your axial resolution target. The typical probe speed should be set as close as possible to the real value. This will help the algorithm that automatically detects landmarks (this will be explained in the Landmarks section). The recommended pulling speed for NFA is approximately 300mm/s.

The *Probe Resolution* (Circular Axis) is defined by  $360^\circ$  divided by the number of pancake coils located on the circumference of the NFA probe. For this instance, the 18mm NFA have 28 coils, so the resolution is  $12.85^\circ$ . The *Displayed Resolution* (Circular Axis) is the number of points displayed in the C-scan and it is defined by the *Probe Resolution* divided by the *Oversampling* (interpolation).

The *Displayed Resolution* (Axial Axis) is defined by typical probe speed divided by the Acquisition rate.

The size is the length of the tube to be inspected. The length needs to be set accurately for the Landmarks work in Magnifi.



If you select to measure the position from Encoder, different fields will appear, and a second *Scan Definition* page will become available.

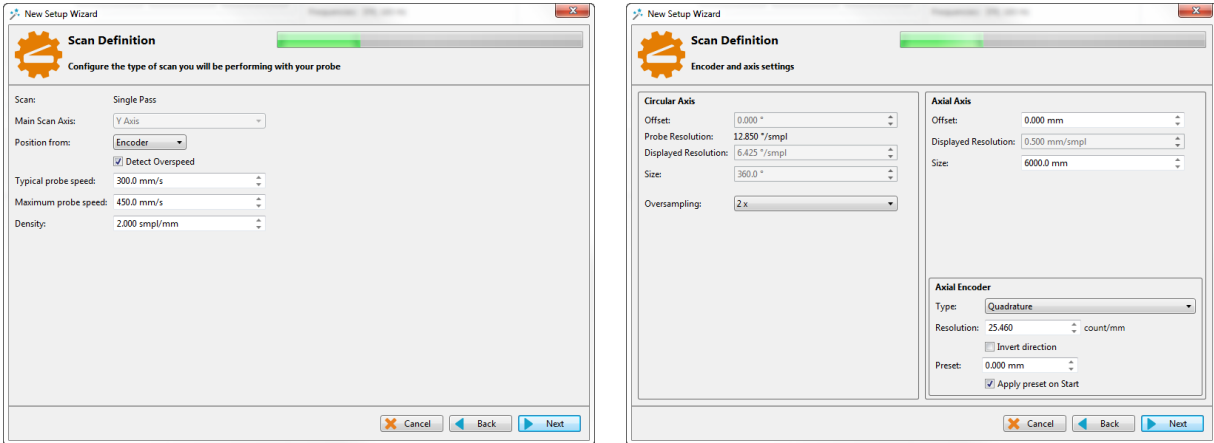

On the first page, the *Typical probe speed*, *Maximum probe speed* and the *Density* will have to be entered. The *Maximum probe speed* is the maximum acceptable speed for your probe and the *Density* is the number of acquired points per millimeter (axial resolution). These values will be used to set the acquisition rate and to optimize the acquisition processes used by the Ectane. Note that if your probe is pulled at a speed exceeding the *Maximum probe speed*, there will be gaps in the data.

The second page includes the type of encoder and its resolution. A preset can also be specified if your acquisition doesn't start at 0 mm.

Click *Next* when you're finished.

## DATA DEFINITION

The *Data Definition* window is used to set the hardware gain, frequency and drive voltage for the Absolute and Array channels. It is important to set these parameters correctly before acquiring the data since they are driven by the instrument and cannot be modified during the analysis. But NFA the set frequency will not change.

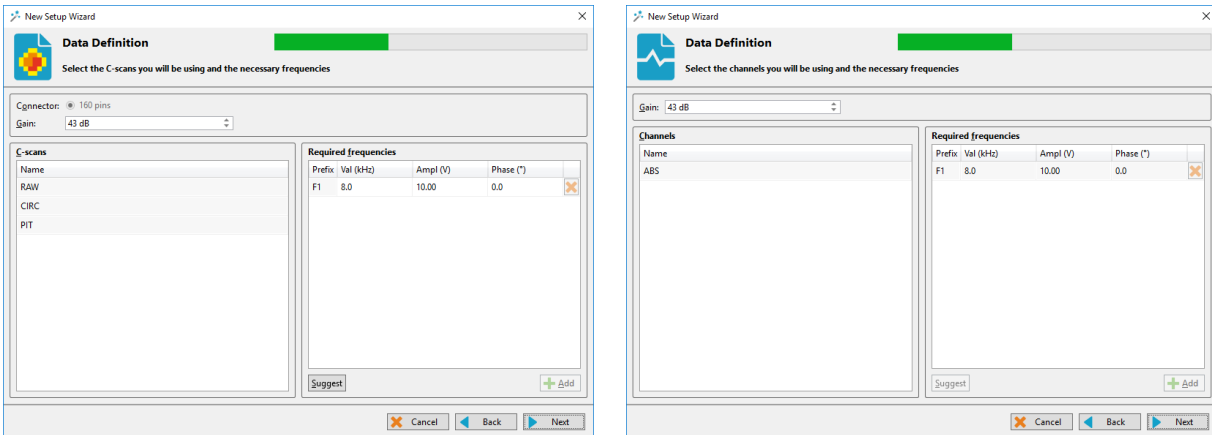

By default, Magnifi suggests one frequency set by default to 8kHz.

But frequency and drive voltage can be changed by replacing the value of your choice. Up to 4 frequencies can be set at the same time. And the sum of their amplitude cannot exceed 10V. Also, the *Absolute* channel(s) cannot use a different frequency than the *Array* channel(s). They are linked together.

Click on *Next* when the desired parameters are entered.

## DATA PROCESSING

The *Data Processing* window is used to configure the signal processing to apply to the channels.

You can choose to configure every frequency individually or you can apply the same filters to every channel with the *Individually configure all the channels* check box.

Note that the signal processing is done after the data acquisition. An inappropriate parameter choice can be changed without any problem during data analysis, while a wrong parameters choice for the data acquisition can mislead the analysis. It is possible to change the filters parameters after the acquisition, so it is always possible to fine tune the filters parameters during the analysis.

Individually configure all the C-scans

Name	Low Pass		Median High Pass	
		Cutoff (Hz)		Window Size (smp)
CIRC	<input type="checkbox"/>	200	<input checked="" type="checkbox"/>	201
PIT	<input type="checkbox"/>	200	<input checked="" type="checkbox"/>	201
RAW	<input type="checkbox"/>	200	<input type="checkbox"/>	101

Cancel Back Next

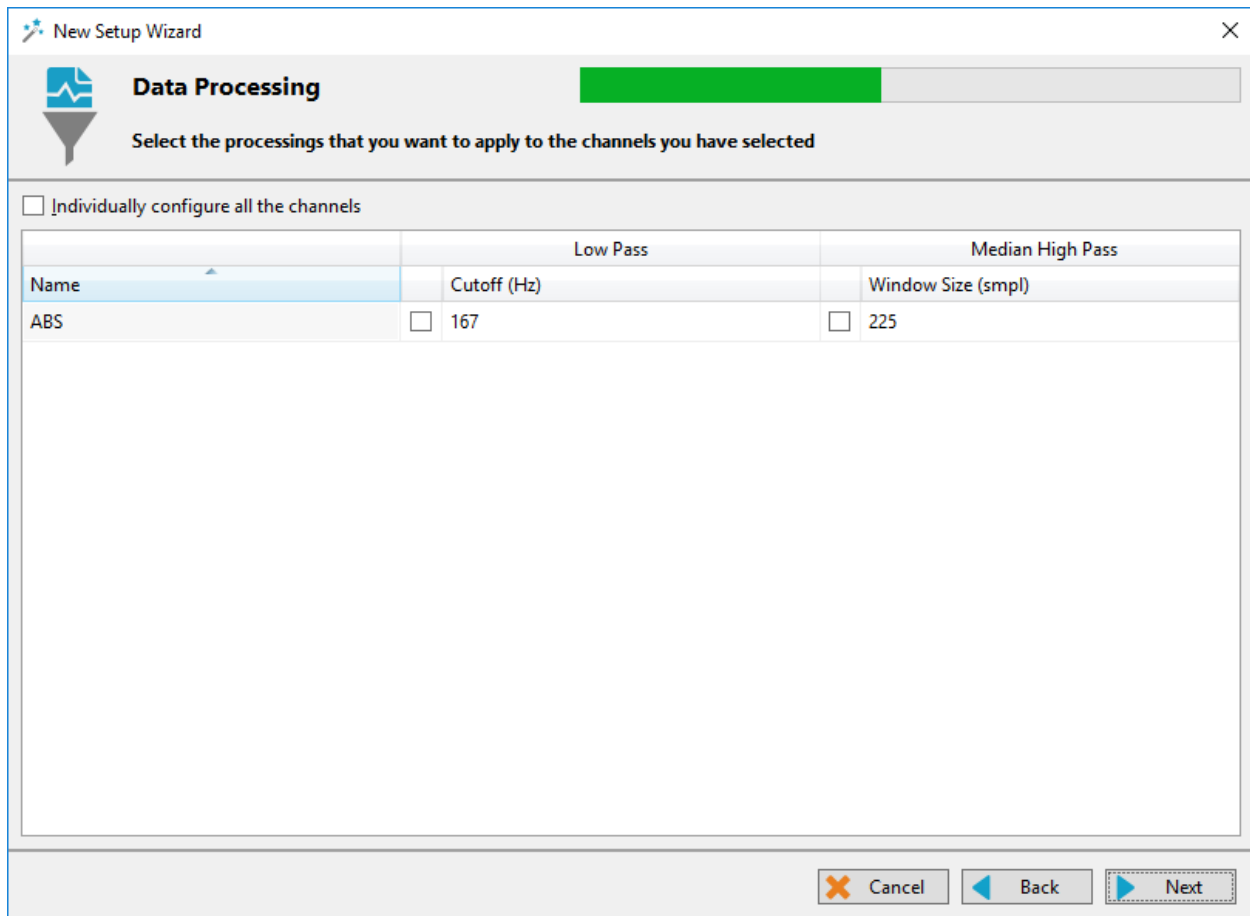

The low pass filter eliminates part of the signal that is above a certain frequency. As an example, it is useful when your defect signal has a lower frequency content than the background noise. In this case, using a filter will remove part of the noise without removing the defect's signals. This may help with data analysis. However, a cutoff frequency that is too high won't remove much noise, and a cutoff frequency that is too low will filter out the defect's signals.

The median high pass filter is used to filter out low frequency noise such as lift-off variations of the probe within the tube, changes in material, geometry or thickness. As a rule-of-thumb, the width of the high-pass median filter should be set to at least three times the axial length of the longest flaw that may be encountered. Data should be examined in both its filtered and unfiltered states. It is important to keep in mind that the median high-pass filters can distort phase. More information about median filters for NDT analysis can be found on Eddyfi's blog.

Click *Next* when you are done.

## CALIBRATION POINTS

The *Calibration Points* page is used to define the points in your calibration tube. These indications will later be used to calibrate your probe and to build sizing curves.

The units of measurement can be set in percentage or in depth (millimeters or inches).

You can add calibration points by clicking on the *Add* button. Specify the calibration point name, side and size. The side and size of the flaw will be used to position the calibration point on the sizing curve(s).

Calibration points can also be imported with the *Import* button.

New Setup Wizard

**Calibration Points**  
Configure calibration points used for channels and sizing curves

Units of measurement: Percentages (%)

**Calibration points**

Name	Side	Size	
GR-20	ID	20.0	X
DO NOT USE	Unknown	0.0	X
TS1	Unknown	0.0	X
TS2	Unknown	0.0	X
RBH-25_9.5mm	ID	25.0	X
RBH-75_9.5mm	ID	75.0	X
RBH-50_3.5mm	ID	50.0	X
RBH-25_3.5mm	ID	25.0	X
RBH-75_3.5mm	ID	75.0	X
GR-40	ID	40.0	X
TAPER-30	ID	30.0	X
TAPER-60	ID	60.0	X
RBH-50_9.5mm	ID	50.0	X
RBH-25_4.7mm	ID	25.0	X
RBH-25_6.3mm	ID	25.0	X
RBH-25_7.9mm	ID	25.0	X
RBH-50_4.7mm	ID	50.0	X
RBH-50_6.3mm	ID	50.0	X
RBH-50_7.9mm	ID	50.0	X
RBH-75_4.7mm	ID	75.0	X
RBH-75_6.3mm	ID	75.0	X
RBH-75_7.9mm	ID	75.0	X
Exit	Unknown	0.0	X

Import Add

Cancel Back Next

Click *Next* when you have set the required calibration points for your calibration(s) and sizing curve(s).

## CALIBRATION

The *Calibration* pages are used to define reference signal(s) that will be used to set the amplitude(s) and phase(s) of each channel using the selected measurement method.

By default, the calibration is performed on the 9.5mm 50% round bottom hole for the array channels. The angle will be 90° for CIRC channel and 42° for PIT and RAW. For all array channels the voltage will be set to 2V. For the conventional channel the GR-20 is set to 2V, 90°. However, the calibration can be done differently on each channel type. It can also be done individually for each frequency by selecting the *Individually configure all the channels* option. Different reference signals can be set to calibrate the phase and the amplitude independently.

New Setup Wizard



**Calibration** 

Configure parameters to calibrate C-scan amplitude and phase

Individually configure all the C-scans

Name	Amplitude			Angle (°)	Phase		SG
	Voltage (V)	Reference	Measurement		Reference	Measurement	
CIRC	2.00	RBH-50_9.5mm	PP	90.0	RBH-50_9.5mm	PPF	<input checked="" type="checkbox"/>
PIT	2.00	RBH-50_9.5mm	PP	42.0	RBH-50_9.5mm	PPF	<input checked="" type="checkbox"/>
RAW	2.00	RBH-50_9.5mm	PP	42.0	RBH-50_9.5mm	PPF	<input checked="" type="checkbox"/>

SG : Single Gain and Phase

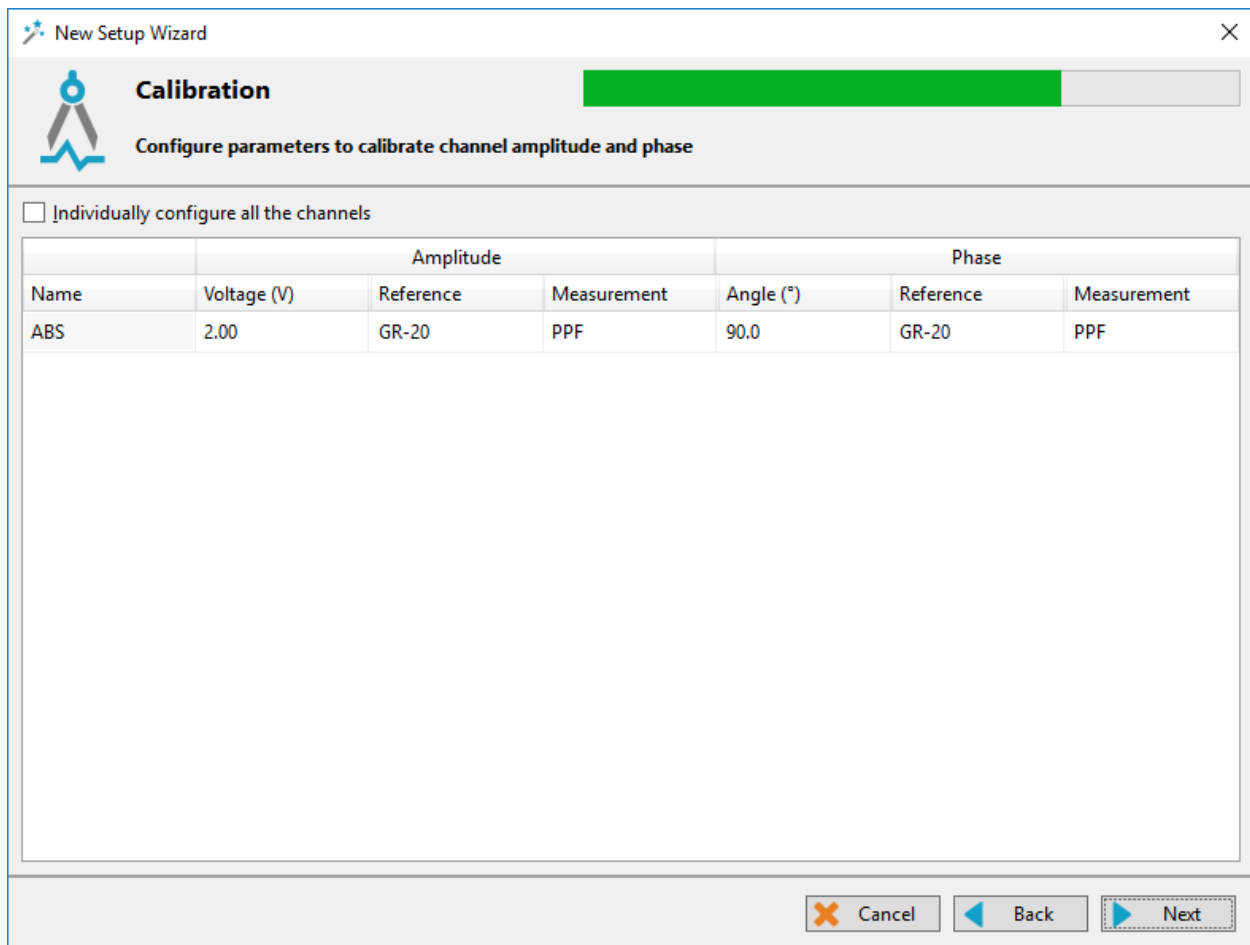

When you select the reference signal, the system will use the selected measurement method to apply a rotation and a gain. Here is a short description of the available options:

1. **Absolute (A):**  
Uses a straight line from the Lissajous origin to the main cursor position to measure amplitude.
2. **Absolute Horizontal (AH):**  
Uses only the horizontal component, from the Lissajous origin to the main cursor position to measure amplitude.
3. **Absolute Vertical (AV):**  
Uses only the vertical component, from the Lissajous origin to the main cursor position to measure amplitude.
4. **Absolute Peak (AP):**  
Uses a straight line, from the Lissajous origin to the peak value of the data selection, to measure amplitude.

- 5. Absolute Peak Horizontal (APH):**  
Uses only the horizontal component, from the Lissajous origin to the peak value of the data selection, to measure amplitude.
- 6. Absolute Peak Vertical (APV):**  
Uses only the vertical component, from the Lissajous origin to the peak value of the data selection, to measure amplitude.
- 7. Average Peak (MP):**  
Takes the distances from points at the extremity of the cursor to the peak of the data selection to build an average vector. Used only and recommended for absolute signals.
- 8. Average Peak Horizontal (MPH):**  
Uses the horizontal component of the distances from points at the extremity of the cursor to the peak of the data selection to make an average vector. Used for absolute signals.
- 9. Average Peak Vertical (MPV):**  
Uses the vertical component of the distances from points at the extremity of the cursor to the peak of the data selection to make an average vector. Used for absolute signals.
- 10. Peak to peak (PP):**  
Uses the combination of the vertical and horizontal component to measure the maximum amplitude.
- 11. Horizontal (PPH):**  
Uses only the horizontal component to measure the amplitude.
- 12. Vertical (PPV):**  
Uses only the vertical component to measure the amplitude.
- 13. Peak to peak First Transition (PPF):**  
Uses the combination of the vertical and horizontal component of the first transition of the signal to measure maximum amplitude. The first signal transition is from the base of an indication to its peak. Click on *Next* when the parameters in the table are set according to your requirements.



## SIZING CURVES

The first page of this section is the definition of your sizing curves. A curve will be built for each line in this table.

ID	Name	Measure From	Source	Measurement	
T	TAPER	Channel	F1ABS	Amplitude	X
G	GROOVE	Channel	F1ABS	Amplitude	X
20	PIT 3.50mm	C-scan Y	PIT	Amplitude	X
28	PIT 4.75mm	C-scan Y	PIT	Amplitude	X
38	PIT 6.35mm	C-scan Y	PIT	Amplitude	X
45	PIT 7.93mm	C-scan Y	PIT	Amplitude	X
55	PIT 9.52mm	C-scan Y	PIT	Amplitude	X

The sizing curve will allow you to estimate the size of a defect based on the calibration points signals amplitude obtained with your calibration standard. Magnifi will give you the interpolated flaw size based on the built sizing curves.

Sizing curve names are customizable. The channel source and measurement type can also be changed. You can add sizing curves by clicking on the *Add* button.

Click *Next* when you are done.

For every sizing curve created in the last window, a window will appear to configure the curve properties. The name of the curve will be shown in the upper left corner of the page (TAPER in the example below).

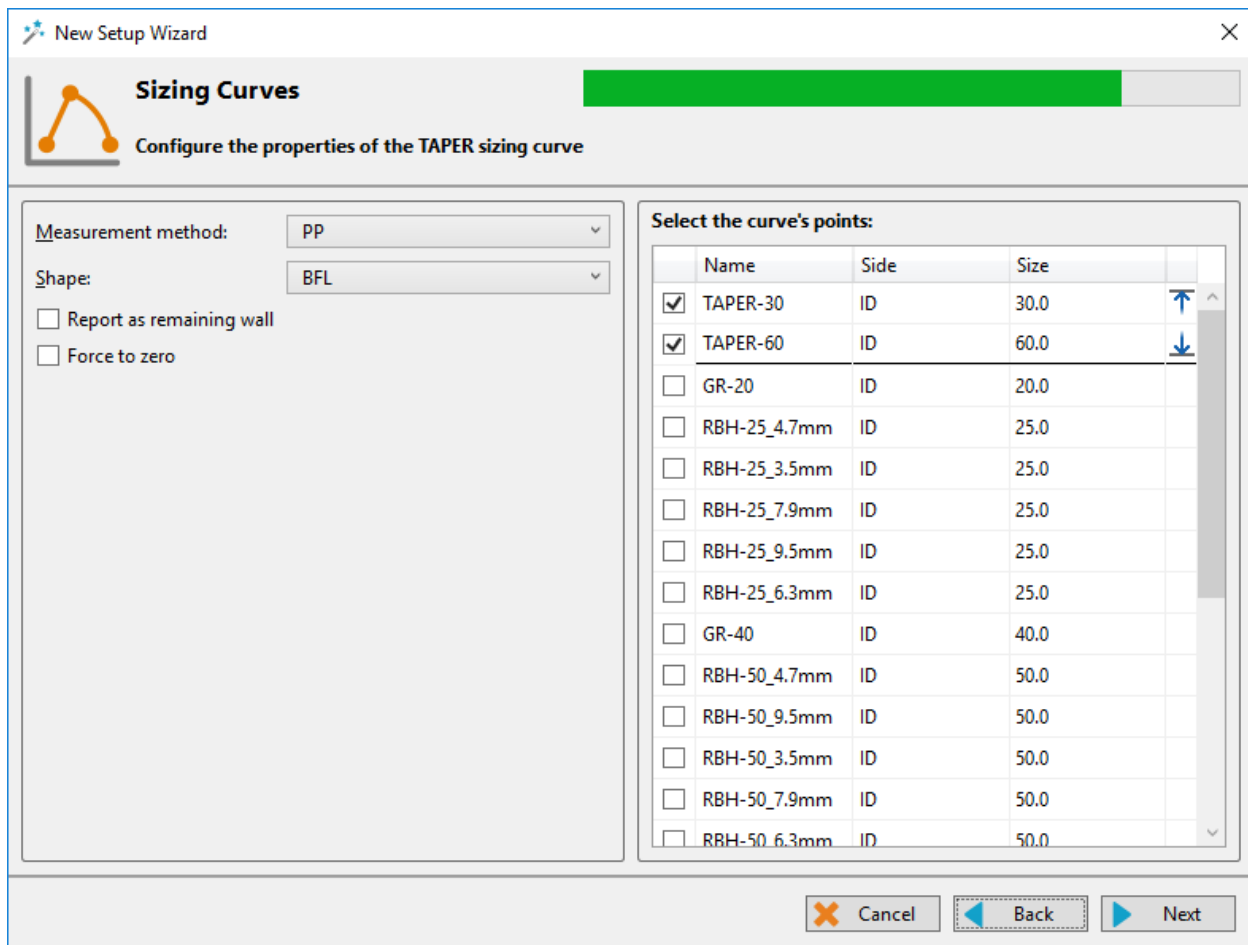

The measurement method options are the same as what is described in the calibration section of this document. By default, the peak-to-peak option is set for all channels.

The interpolation method can be selected with the *Shape* dropdown menu. Here is a short description of the available options:

1. **Best Fit (Dual linear) (for phase measurement only):**  
A curve with two linear segments representing ID and OD (or Near and Far) side calibration points with respect to phase.
2. **Best Fit (Dual Slope) (for phase measurement only):**  
A curve with two segments representing ID and OD (or Near and Far) side. The ID section is linear and the OD section is polynomial. The OD side of the curve will need at least three points (including the hole) in order to trace a polynomial curve.
3. **Best Fit (Polynomial) (for phase and amplitude measurements):**  
Best polynomial (degree 2) interpolation within the measured calibration points (requiring at least three points).
4. **Connected Points (for phase and amplitude measurements):**  
Simple, point-to-point curve.

**5. Best Fit (Linear) (for phase and amplitude measurements):**

Best linear interpolation within the measured calibration points

**6. Best Fit (Dual Polynomial) (for phase and amplitude measurements):**

Polynomial (degree 2) interpolation with two segments for both ID and OD side of the curve.

Need at least three points.

The linear options are mostly used when few data points are available, while the Best fit (Dual Polynomial) option is a more precise method when your calibration tube has multiple defects.

Once the measurement method and the interpolation curve shape are chosen, you can select the curve points for each sizing curve previously created. The order in which the points appear in the list may influence your sizing curve. Make sure that the measured values of the calibration points are in ascending order on the list. You can set Magnifi to show the remaining wall instead of the defect size by checking the box *Report as remaining wall thickness*.

Click *Next* when you are done.

## INDICATION CODES

The *Indication Codes* page is used to define the entries that can be added to the report when analyzing the data.

Code	Description	Type	Automatic	Color	
COR	Corrosion	Defect			X
CRK	Crack	Defect			X
DNT	Dent	Defect			X
DSI	Distorted support indicatic	Defect			X
ERO	Erosion	Defect			X
NDD	No defect detected	No indication			X
OBS	Obstructed	Feature		Red	X
PIT	Pitting	Defect			X
PLG	Plugged	Feature		Brown	X
RST	Restricted	Feature		Yellow	X
WLL	Wall loss long	Defect			X
WLS	Wall loss short	Defect			X
WLT	Wall loss taper	Defect			X

When an indication is added, its abbreviation (code) is shown in the code pane, next to the data.

You can modify the default indications codes list by changing the parameter in the table. New indications can be defined by clicking on the *Add* button.

Click *Next* when you are done

## DISPLAY

The first *Display* window is used to set how the data is displayed during and after the acquisition.

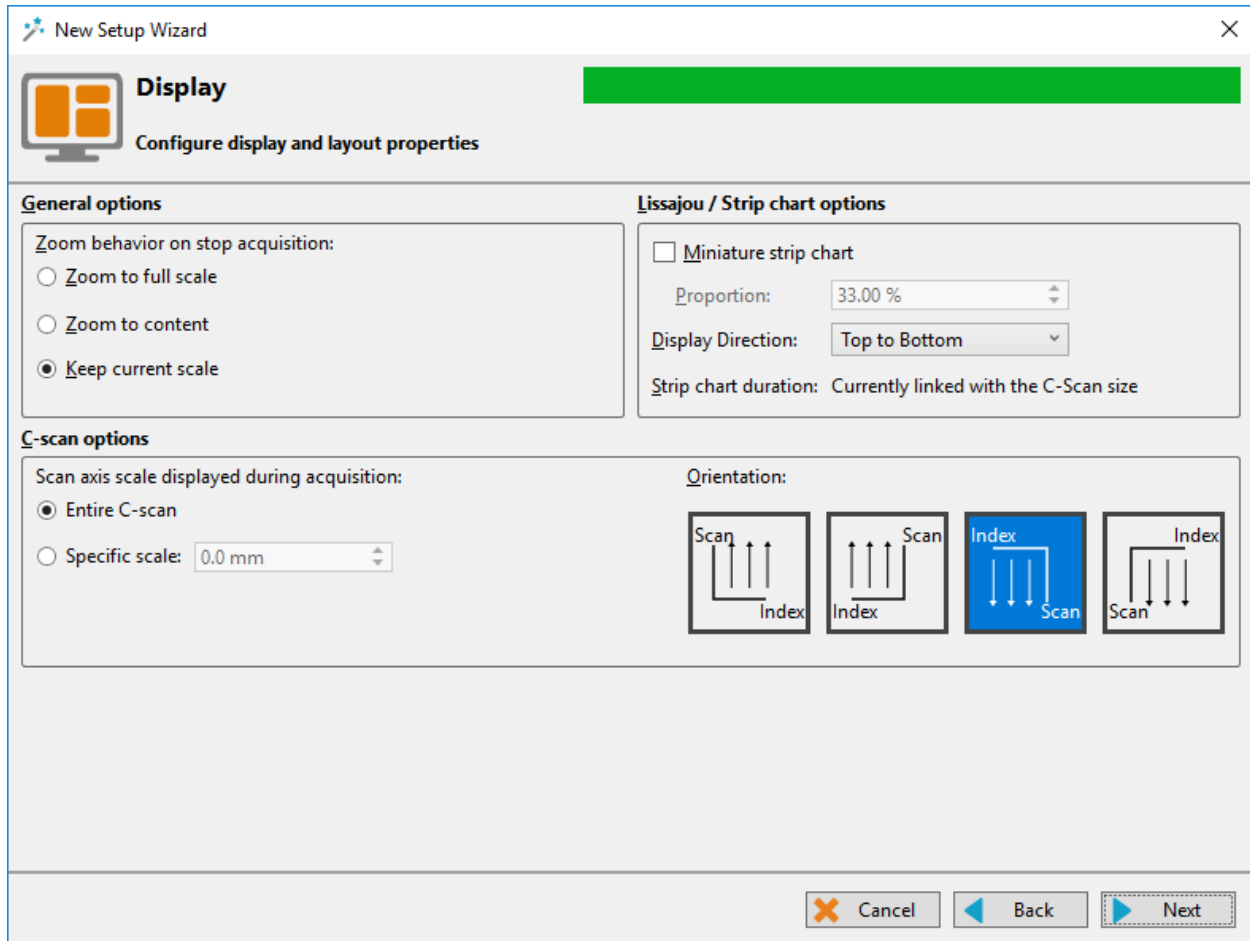

The scroll direction is the direction in which data appears on the screen. If you choose downward, the signals will go from the top to the bottom of the screen. If you choose the upward direction, the signal will go from the bottom to the top of the screen.

You can enable/disable the miniature strip chart under the Lissajous by checking/unchecking the box.

The strip chart duration is the length of a Strip chart window when the data is acquired.

Click *Next*.

The second *Display* window is used to set the layouts. Checking the tick boxes in this window will make the proposed layouts available in your setup. You will be able to switch from one the another via the layout tab The " C " stands for code, " S " stands for Strip chart, " L " for Lissajous, " CS " for C-scan and " CS-3D " for 3D C-scan.

The layout with the blue background will be the one opened by default, which can be changed to your desired option.

Layouts can be readjusted at any time.

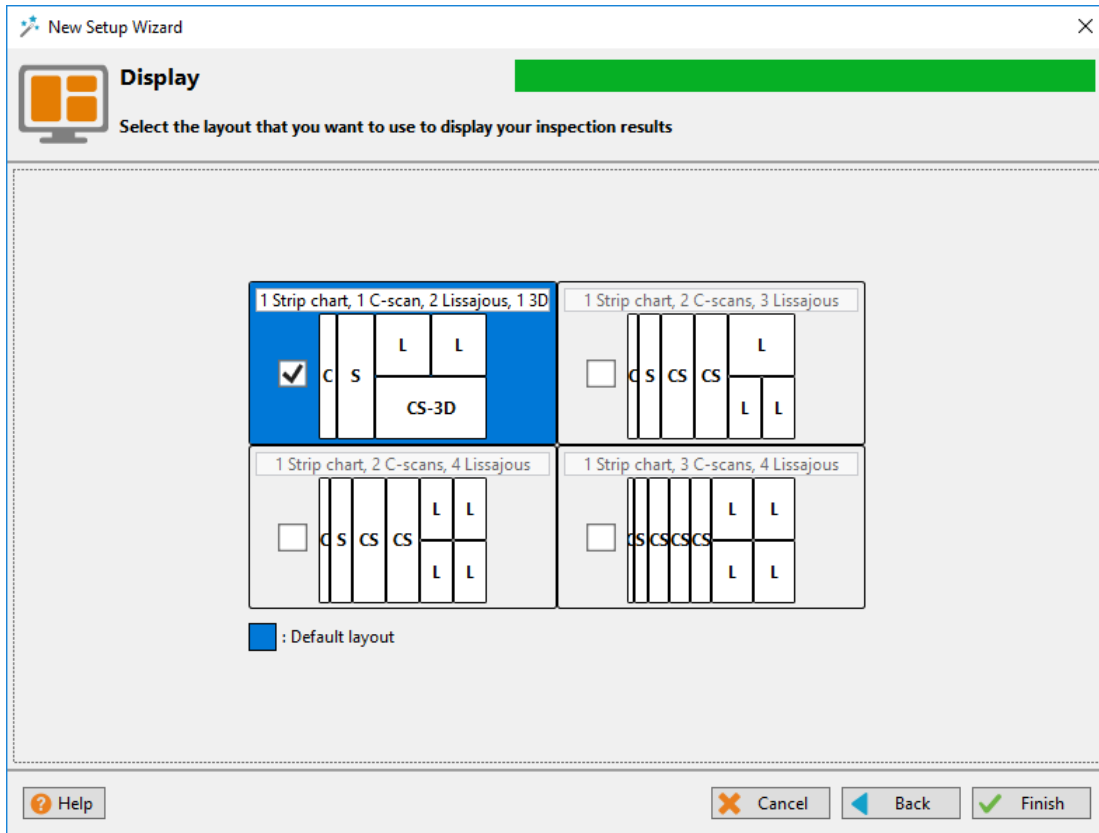

Click *Next* to complete the setup wizard process.

## SETUP MODIFICATIONS

Some parameters or preferences may need to be modified after the Setup Wizard process. To modify the parameter previously entered, you can go to the *Setup* tab in the *Frontstage* and click on the button associated with the parameter you want to change.

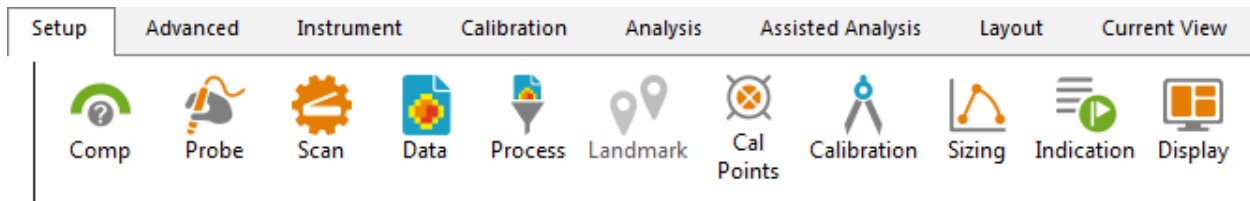

This will open one of the windows previously described, where you can change the values you originally entered. If applicable, go through the process by clicking on *Next*, and then click on the *Finish* button. This will apply the modification to the setup.

Advanced settings can be found under the *Advanced* tab of the *Frontstage*. If parameters are changed using advanced settings, the information shown using the *Setup* tab may not match your actual setup.

## SMART SETUP TOOLS

---

Additional functions, which facilitate data analysis, can be set up under the SMART Setup tab.

### LOGBOOK

The first button on the left side under the SMART Setup tab allows you to enable or disable the logbook.

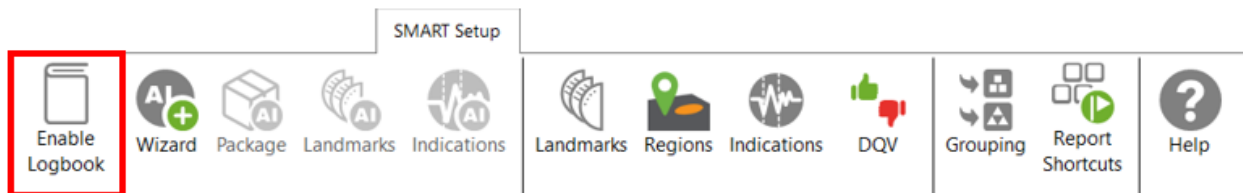

The logbook stores information about the analysis in addition to allowing the following functions: batch screening, seeing results at a glance from the data list pane and saving manual modifications made to the landmarks during the analysis.





The logbook stores the following information: landmarks (type, position, dimension, including manual modifications), indications (AI and conventional, label, position, dimension, etc.), indication grouping, and data quality validation results. When enabled, an additional column is added to the data file list to allow seeing results and to filter, sort, or analyze according to these results.

Zone	Row	Col	Icon
✓ 000	001	001	7x
✓ 002	005	005	3
✓ 002	009	007	2 2
✓ 003	004	009	2
✓ 003	005	012	2
✓ 003	006	007	8
✓ 003	007	006	1
✓ 003	007	010	1
✓ 003	009	007	
✓ 004	003	010	10 2
✓ 004	003	015	1
✓ 004	004	009	18 2
✓ 004	004	014	27 3
✓ 004	005	008	
✓ 004	007	005	
✓ 004	007	015	1x
✓ 004	009	010	2
✓ 004	010	010	Warning

The following table shows the possible icons and their meaning:

Icon	Description	Meaning
(empty)	Empty	No logbook entry associated with this file because it has not been screened yet.
	Dashed outline circle, without a number	Logbook entry associated with the file contains information such as landmark detection or regions. The absence of additional information on the icon reveals that no indication detection engine or DQV tests were enabled when the logbook was written.
	Dashed outline circle, with a number	Logbook entries associated with the file contains information such as landmark detection as well as detected indications. The number displayed inside the circle shows the quantity of potential indications detected. No DQV tests were enabled when the logbook was written.
	Dashed outline circle, with a green check mark	The green check mark indicates that the DQV test(s) passed on this file.



	Dashed outline circle, with a red cross	The red cross indicates that at least one DQV test(s) failed on this file.
	Dashed outline circle, with a number, with a green check mark	The logbook entries associated with this file indicates that potential indications have been detected by the detection engine and that the DQV test(s) passed.
	Dashed outline circle, with a number, with a red cross	The logbook entries associated with this file suggest that potential indications have been detected by the detection engine and that at least one DQV test(s) failed.
	Orange warning triangle	The AI detection tools identified an unusual situation. In this case, the level of confidence in the detection findings could be very low. Therefore, users should pay special attention when reviewing the detection results.

The logbook is saved within the inspection folder. Its data is written when a file is screened using the dedicated buttons in the Analysis ribbon. It is also automatically written when a file is loaded while the logbook is enabled, and no logbook entry existed for this file yet.

It is worth mentioning that the logbook also includes defects and landmarks, even if these have been detected with detection tools that do not use AI (conventional landmark detection and indication boxes). Also note that the automatic indication detection tools are not available if you use the acquisition license (ACQ).

## LANDMARKS

The Landmarks button is used to setup the parameters for landmark detection with conventional tools.

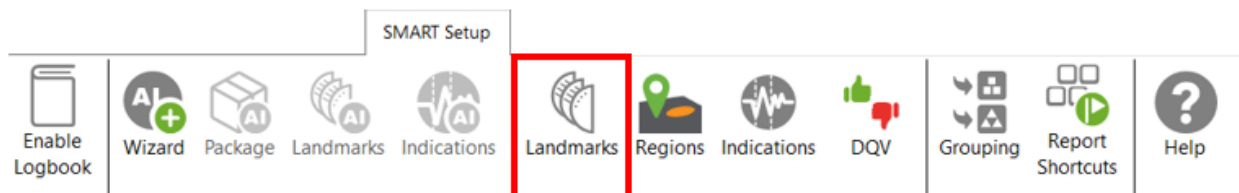

The Landmark Detection window is used to configure the automatic detection of features such as tube sheets and support plates. Landmarks are not mandatory and don't need to be set to have functional setup. They can however give a reference for the axial position in a tube. They can also be used by the software to trigger automatic acquisition sequences.

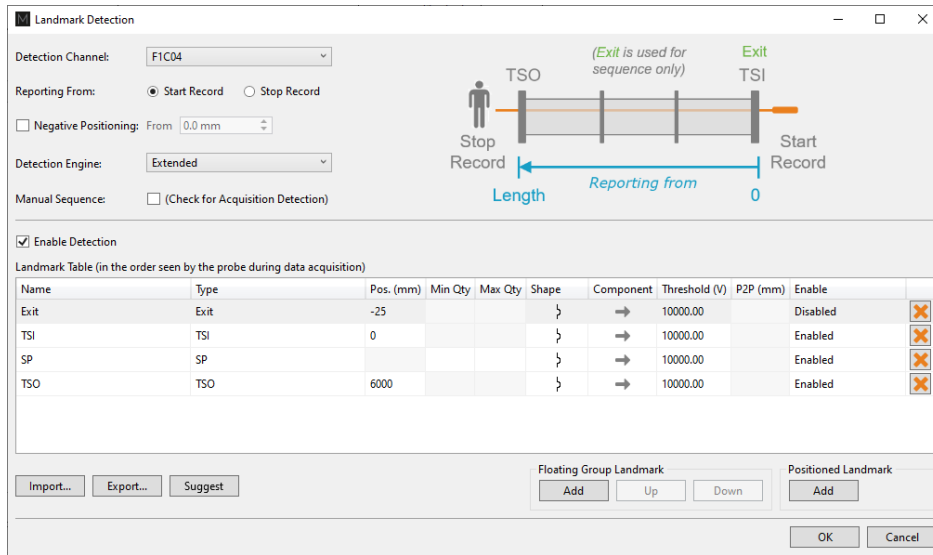

Three landmarks are created if you press on the Suggest button. The channel selected to detect these landmarks should be the lowest frequency absolute channel. The R\_ before the channel stands for Raw. This is the signal of the channel without software filter, rotation, or software gain applied.

You can base the position of your landmarks either on the location where you start to record (usually the tube entrance, opposite from the operator position) or on the place you stop to record (usually the operator side).

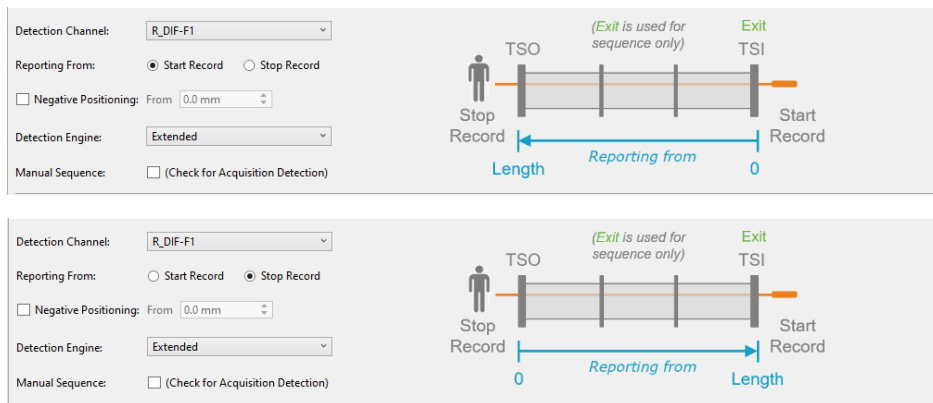

In the above example, the Exit landmark is detected when the probe exits the tube at its outer end. It has a negative position because this event happens before entering the tube. It is enabled only when doing the acquisition.

TSI is the first tube sheet encountered when the probe is pulled. TSO is the last tube sheet encountered at the end of the acquisition.

Landmark detection can be set up manually by describing the shape, component, and voltage threshold that will trigger the detection. The Shape describes the appearance of the signal when the landmark is reached. If a differential signal shape is chosen, the Peak-to-Peak distance ("P2P") will also be needed. The Direction is the projection axis (horizontal or vertical) of the Lissajous signal that will be taken to trigger the landmark. And the Threshold is the voltage amplitude threshold.

Landmarks can be calibrated on real signals; in this case, there is no need to change these parameters as they will be automatically measured by the software. It's important to set the landmark positions as accurately as possible. If the position is not accurately set, the software might prevent their automatic detection since it won't be at an expected position.

The Type field is a name that associates the calibration point with the landmark. If landmarks share the same Type, they will be calibrated at the same time using the same point and process. To associate two landmarks with the same Type, their signal must be the same. If support plates of the same geometry are present in a bundle, they can share the same Type. In the above example, TS1 and TS2 don't share the same Type because one is triggered when the probe goes inside the tube and the other is triggered when the probe exits the tube.

The Detection Engine drop-down menu can be set to Legacy or Extended. With the Legacy mode, all the landmarks need to be entered with the right position. The system will look for the exact number of landmarks entered at positions close to those entered in the table. With the Extended mode, the system will look for a number of landmarks between the Qty max and the Qty min. With this mode, the exact number of support plates don't need to be constant or known.

## REGIONS

The Regions option allows the user to define inclusion/exclusion zones based on Landmarks. This is used to categorize the data to process correctly. For example, they can be useful for restricting the detection of channel saturation to an area within the tube or specify an automatic analysis type for a given region (e.g., under the tubesheets).

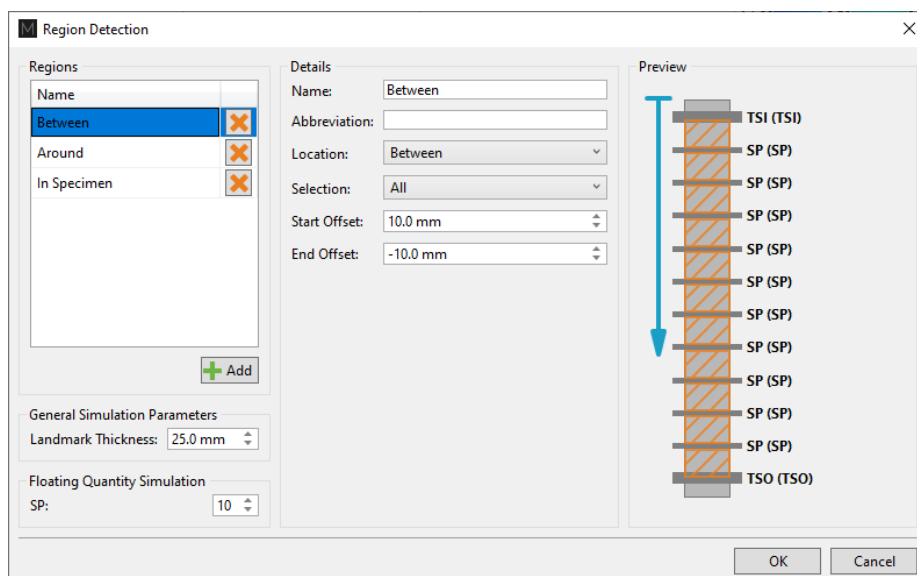
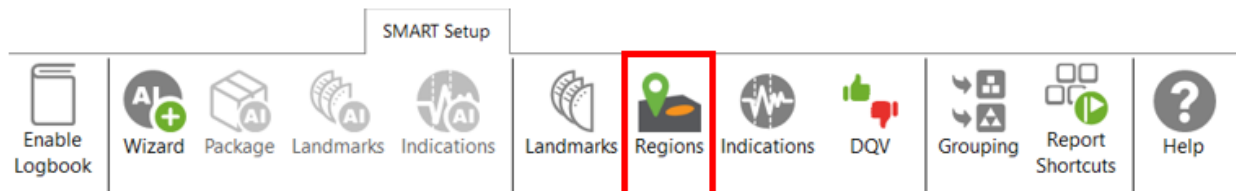

If you are using the conventional detection tools, you can set up the regions according to the automatic analysis tools you will use with the Indications and DVQ buttons (described later).

## INDICATIONS

The Indications module allows the user to define various zones or even waveform types to trigger a certain detection threshold.



These detection zones can be applied to conventional channels and C-scan channels. The Label is the name that will appear in the Code view.

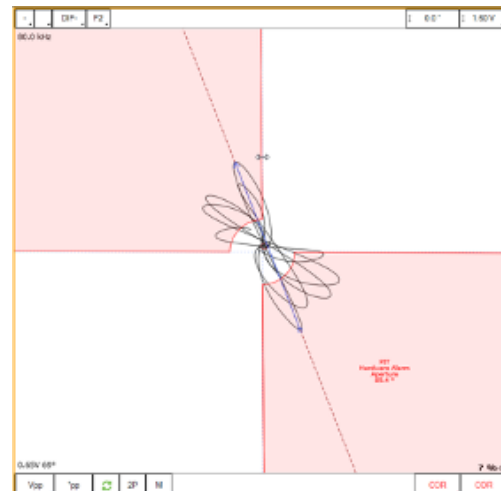
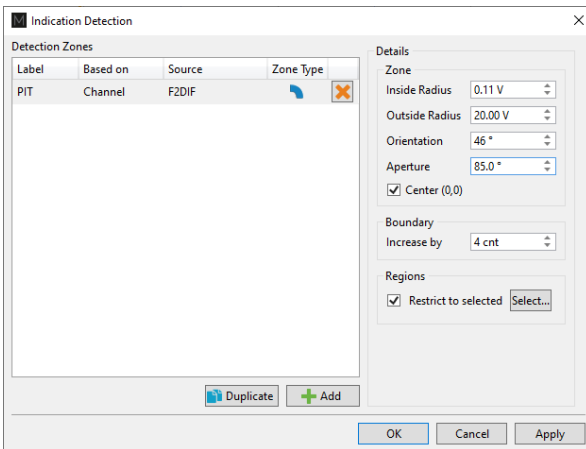





There are five zone types:

	Absolute pie
	Differential pie
	Centered rectangle
	Rectangle
	Over or under a horizontal or vertical threshold

And seven waveform types:

	Up
	Down
	Down-up

	Any direction
	Up-down
	Down-up-up
	Up-down-up-down

Each zone or waveform can be linked to a defined region, and thresholds can be set. The zone types also include the boundary setting to prevent signal oscillation from triggering unnecessary detections.

Detection zone parameters can also be set by clicking on the Lissajous of the used channel and activating the Edit Alarm option on the Current View tab.

The detected indication can be found in the Indication window, which can be activated in the Layout tab.

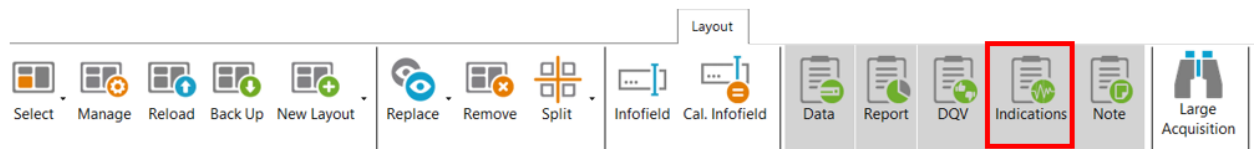

Clicking on an indication in the pane instantly positions the cursor on the selected indication in the Strip chart view. If you click on an indication in the code view (described later), the associated indication is highlighted in the Indications pane.



## DATA QUALITY VALIDATION (DQV)

Data Quality Validation allows defining tests to validate the quality of the data.

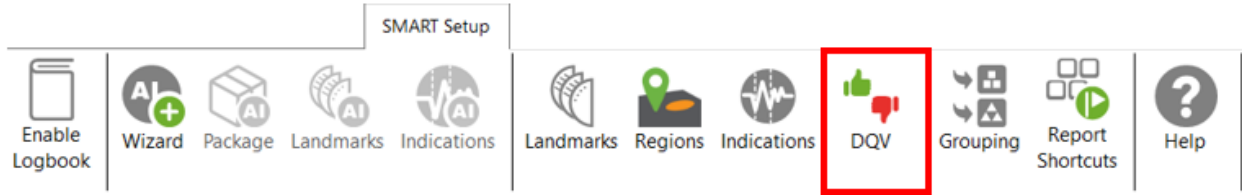

Five test types are available. To add a test, click on the Add button on the DQV page and select the test type with the drop-down menu. Parameters associated with this test can be changed in the Details section of the DQV window.

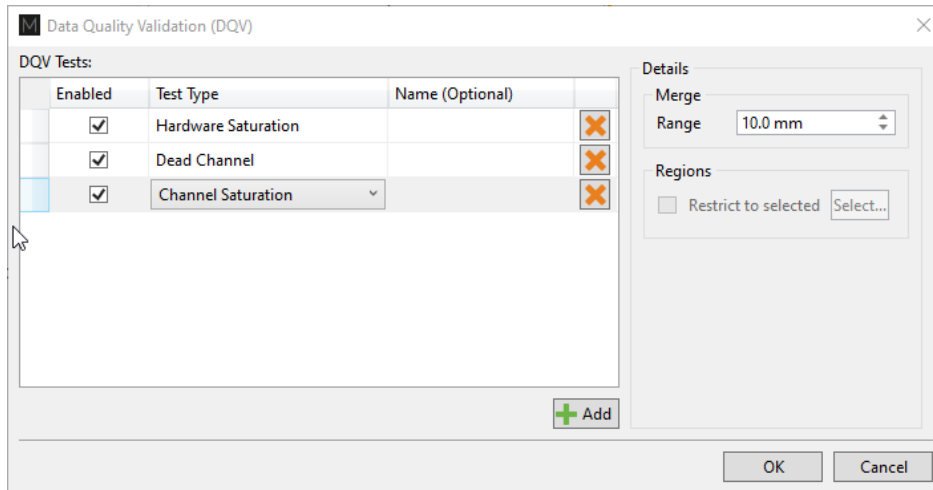

- **Dead Channel:** Verify that channels are reading a signal whose amplitude is above a defined threshold. An amplitude that remains below the threshold throughout the scan indicates a dead channel.
- **Landmark Detected:** Verify the presence of all the selected landmark names in the Details section. To validate full tube-length of straight bundles for ECT bobbin data using AI detection, select this option and check the TSI and TSO landmarks. When AI setup for landmarks is completed and the TWH calibrated, the DQV test will automatically use the AI results to perform the test.
- **Hardware Saturation:** Verify if signal saturation appears on raw channels. The merge field allows grouping a zone together for which the test has failed. This function avoids having many notifications if the test fails several times in one area. This test can be limited to a specific region, for example, the areas inside the tube.
- **Channel Saturation:** Verify if signal saturation appears on calibrated channels. The merge field allows group a zone together for which the test has failed. This function avoids having many notifications if the test fails several times in one area. This test can be limited to a specific region.
- **C-scan Saturation:** Verify if signal saturation appears on C-scans. The merge field allows grouping a zone together for which the test has failed. This function avoids having many notifications if the test fails several times in one area. This test can be limited to a specific region.

The results of the DQV tests can be found in the DQV window, which can be activated in the Layout tab.

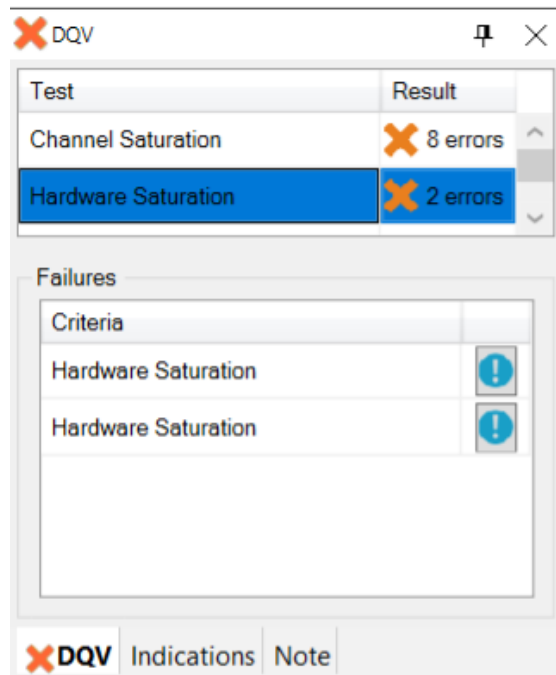
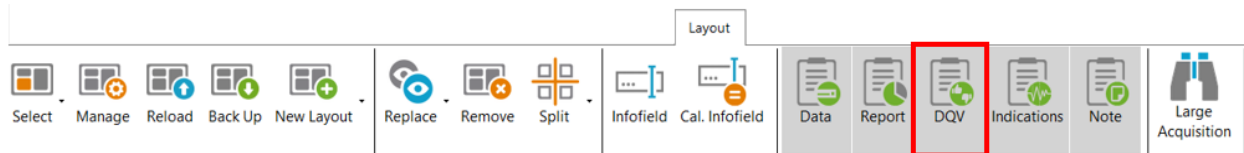

## GROUPING

The grouping tool can help the analyst find critical indications for review as it categorizes and groups the automatically detected indications.

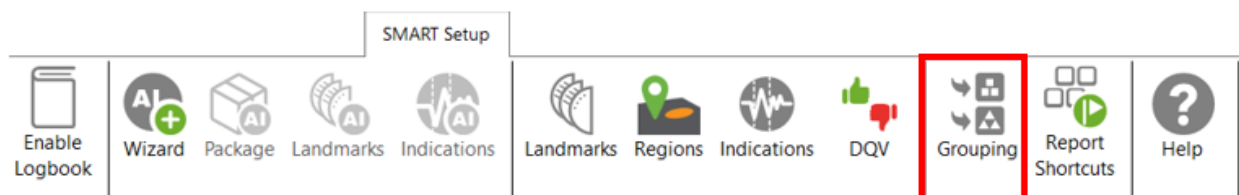

The Grouping menu offers a default configuration with three predefined categories:

- Support Plates
- Critical
- Less Critical

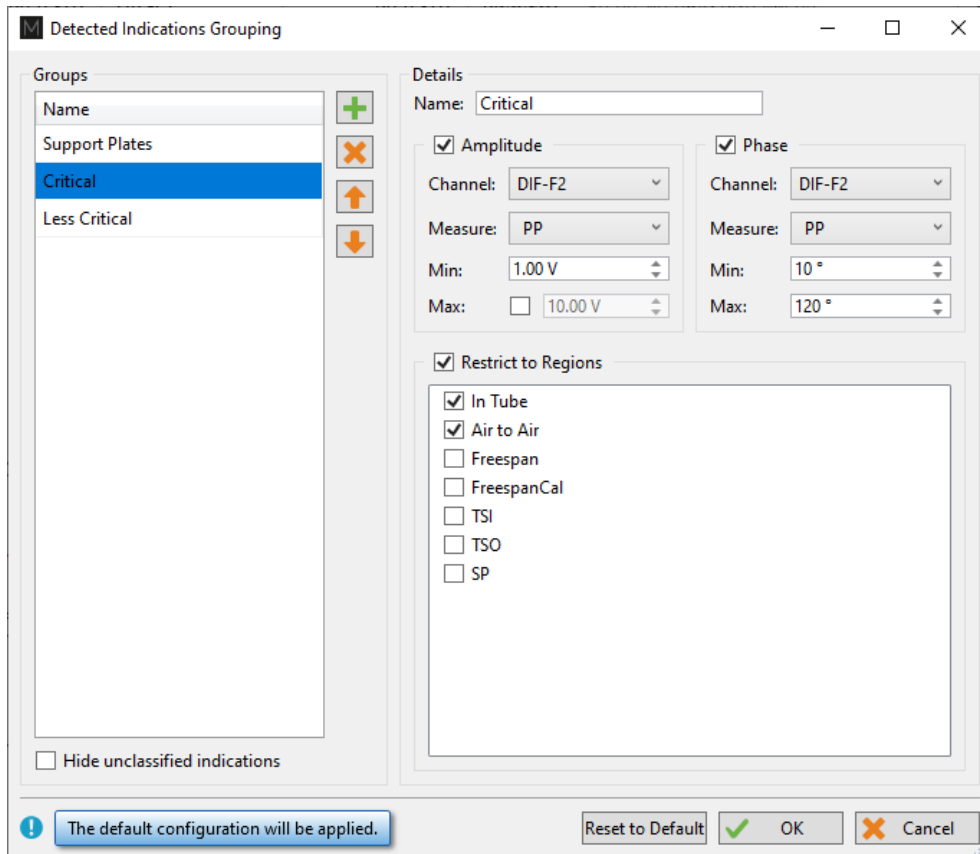

The Details section of each group shows the parameters defining the conditions that must be met for a detected indication to be classified in this group. The user can modify all parameters.

By default, the Support Plates group is configured with the mix channel with a Peak-to-Peak (PP) measurement method, and Max/Min threshold values are set for amplitude and phase. For this group, the criteria are limited to indications detected under the SP regions. As a result, the indications detected under support plates for which all conditions are true will fall into this category.

Critical and Less Critical are two other groups predefined in the Grouping window. Both groups are set on DIF-F2 channel, but with different Amplitude/Phase measurement settings. In both cases, the grouping criteria is restricted to In Tube and Air to Air (for calibration tubes) regions, which covers the full-tube length data.

It should be noted that each automatically detected indication can only be categorized in a single group. Also, the grouping operation is executed according to the order of the groups defined in the Groups list. Therefore, if a given indication meets all the criteria of the first group, it will be categorized in this group. If not, it will be passed to the following group. If it meets all the criteria of the second group, it will be categorized into this one. If not, it will again be passed to the next group, and so on. If an indication does not meet the criteria of any group, it will be placed in the Unclassified group. This implies that every single indication will be categorized, and none can appear simultaneously in more than one group.

New groups can be created with custom parameters.



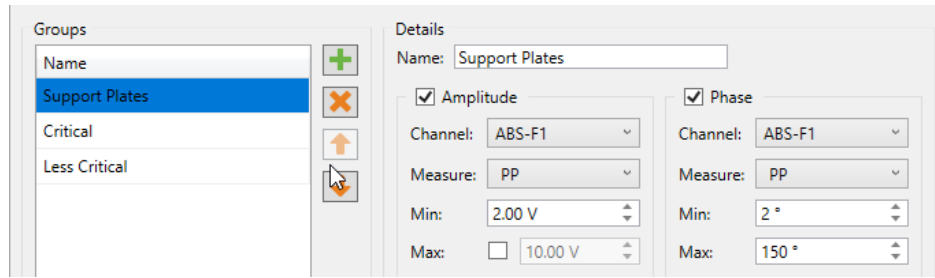

It is also possible to remove a group or use the up/down arrow keys to change the group priority within the list.

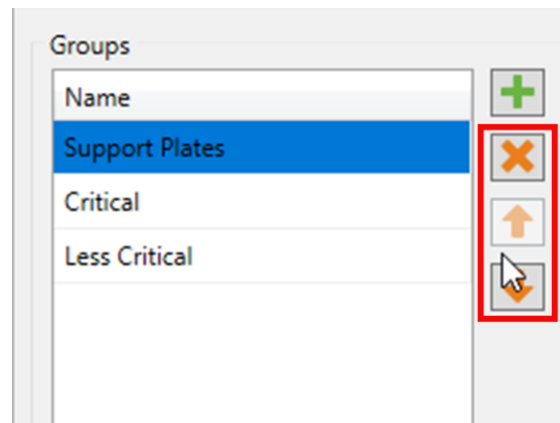

In the Front stage interface, the Grouping results will be displayed in the Indications pane.

Label	Ampl.	Phase
<b>^ Critical (4)</b>		
IND	14.15 V	82 °
IND	3.40 V	83 °
IND	2.78 V	106 °
IND	7.06 V	16 °
<b>^ Less Critical (4)</b>		
IND	1.02 V	111 °
IND	1.00 V	40 °
IND	1.27 V	56 °
IND	1.13 V	73 °
<b>^ Unclassified (2)</b>		
IND		
IND		

To help the analyst focus on the most relevant detected indications furthermore, it is possible to hide the Unclassified indications. To accomplish this, check the box “Hide unclassified indications” at the bottom of the Grouping menu and click on OK.

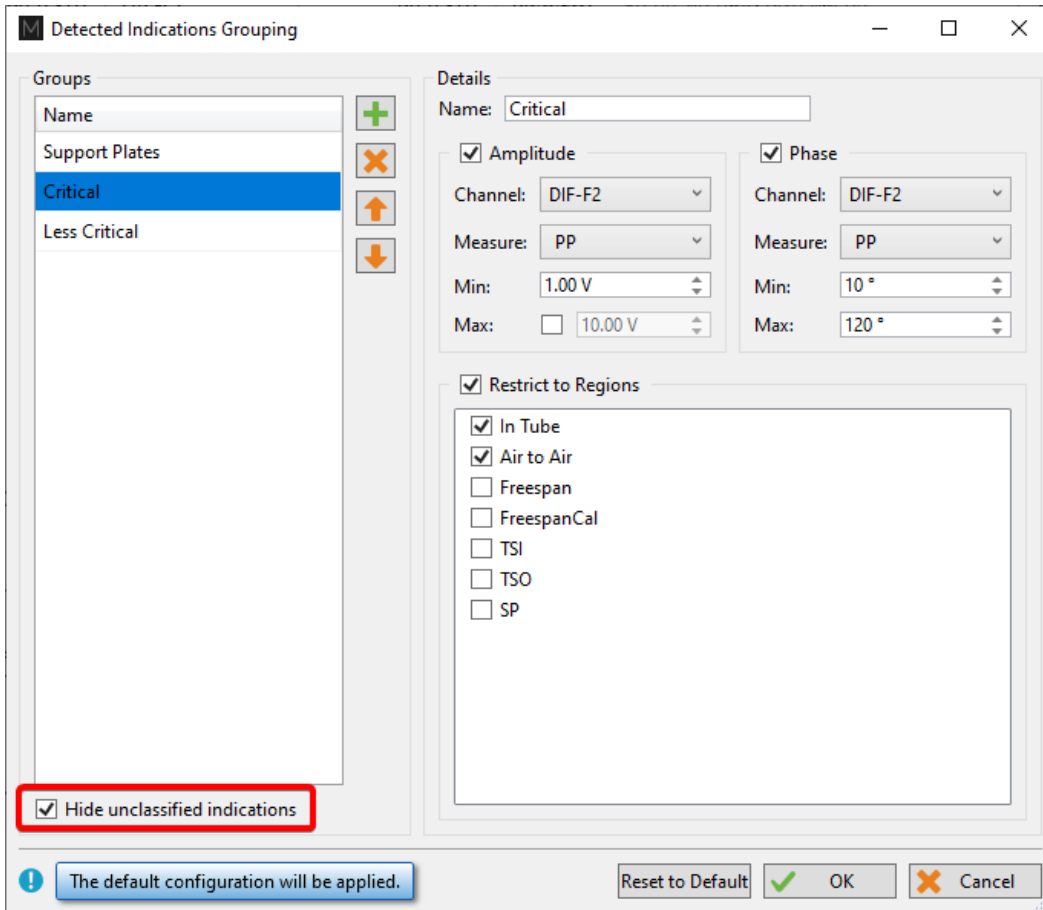

Enabling this option influences the following elements of the software:

- Indications pane;
- Code view;
- Logbook column.

The images below compare them when the Unclassified indications are shown (left) and when they are hidden (right).

When the option is enabled, the Indications pane will not show the “Unclassified” group. The count in the header serves as a reminder to the user that not all indications are currently shown.

Indications 26 of 26 results

Label	Ampl.	Phase
<b>^ Critical (1)</b>		
IND	1.53 V	17 °
<b>^ Less Critical (5)</b>		
IND	1.00 V	14 °
IND	0.93 V	10 °
IND	0.84 V	18 °
IND	0.76 V	17 °
IND	1.20 V	19 °
<b>^ Unclassified (20)</b>		
IND		
IND		
IND		
IND		
IND		

DQV **Indications** Note

Indications 6 of 26 results

Label	Ampl.	Phase
<b>^ Critical (1)</b>		
IND	1.53 V	17 °
<b>^ Less Critical (5)</b>		
IND	1.00 V	14 °
IND	0.93 V	10 °
IND	0.84 V	18 °
IND	0.76 V	17 °
IND	1.20 V	19 °

DQV **Indications** Note

In the Code view, the red markers from the Unclassified indications have been removed.

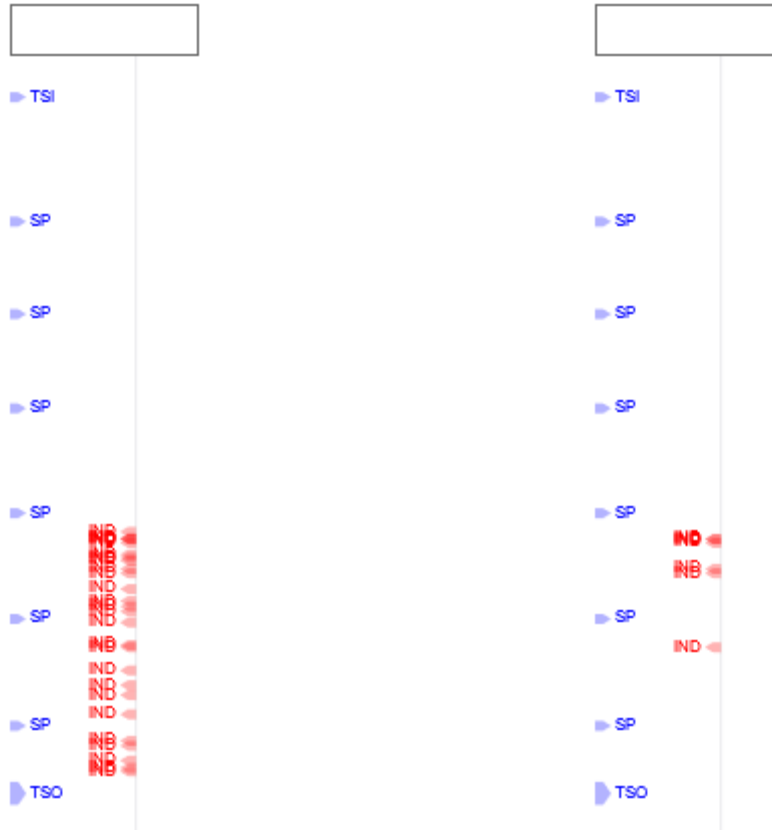

In the data file list, the number shown in the Logbook column represents the number of visible indications, matching the number shown in the header of the Indications pane.

Data		↑	×
7 of 7 data		⏏	
Row	Col		
✓	201000001		
✓	201004005		
✓	<b>201006009</b>	(26)	
✓	201006016		
✓	201024022		
✓	201025017		
✓	201025019		

Data		↑	×
7 of 7 data		⏏	
Row	Col		
✓	201000001		
✓	201004005		
✓	<b>201006009</b>	(6)	
✓	201006016		
✓	201024022		
✓	201025017		
✓	201025019		

## REPORT SHORTCUT

Keyboard shortcuts can be used to make entries in the report. By opening the shortcut window, it is possible to select a channel with a measurement method and to associate an indication with it.

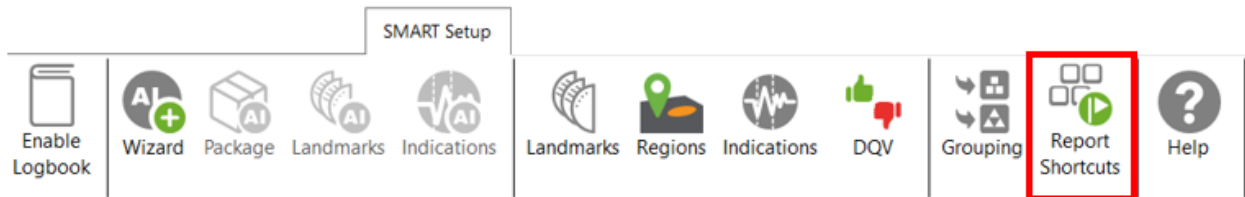

For example, we could use the differential channel F2 with a Peak-to-Peak measurement method to enter pits in the report.

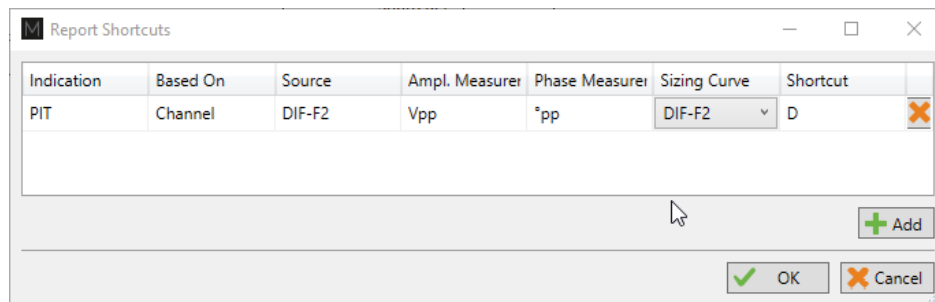

To select a key, press the Shortcut field and press the desired key on your keyboard. It is possible to use a single key or a combination of keys such as ALT+D, for example.

When a report entry is made with the keyboard shortcut, the abbreviation of the type of indication displays momentarily on the corresponding Lissajous.

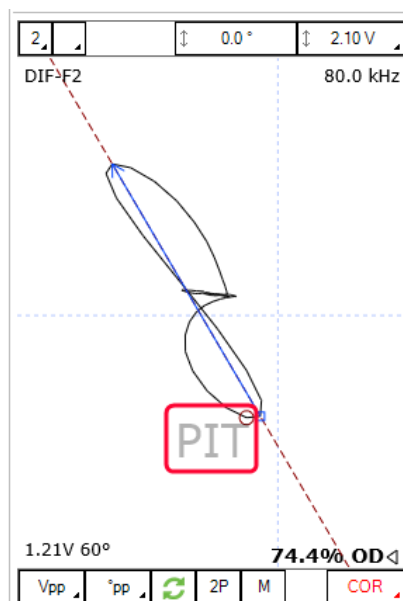

## DATA SCREENING

Data screening set up with the SMART Setup tools can be performed by the two buttons on the left under the Analysis tab.



It is possible to run analysis on a selection of files or all files. The analysis is typically performed on all files when the setup and calibration are adequate. The results are recorded in the logbook and can be viewed in the Data window.

## DATA LIST

Magnifi will create a file for each inspected tube. The list of tubes can be created in the *Data List* section of the *General* tab of the *Backstage*.

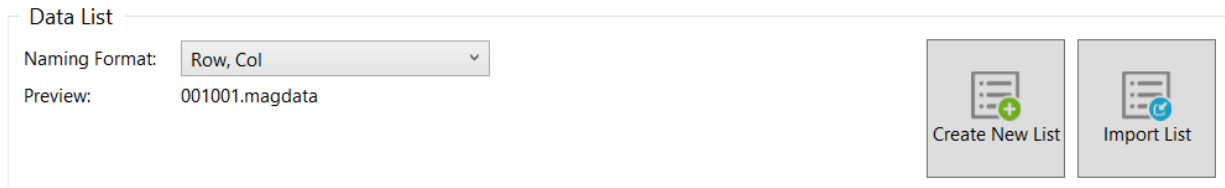

Four options are available to set the filename format:

- 1. Free format:**  
Each file has a custom name. Can also be defined from the Data tab of the Front Stage.
- 2. Prefix:**  
The file name includes a defined prefix followed by a sequential number.
- 3. Row, Col:**  
Row number, Column number. Mostly used for tubing inspections.
- 4. Zone, Row, Col:**  
Zone number, Row number, Column number. Mostly used for tubing inspections.

Click on the *Create New List* button. The displayed window will be different depending on the chosen filename format.

For the *Row, Col* option, enter the number of rows, the starting row number and row interval. You can then enter the number of tubes per row in the *Nb. of Columns* fields of the table. Click on *Create* to

generate the list of tubes. You can also use the *Create & New* button to add another set of tubes to your list.

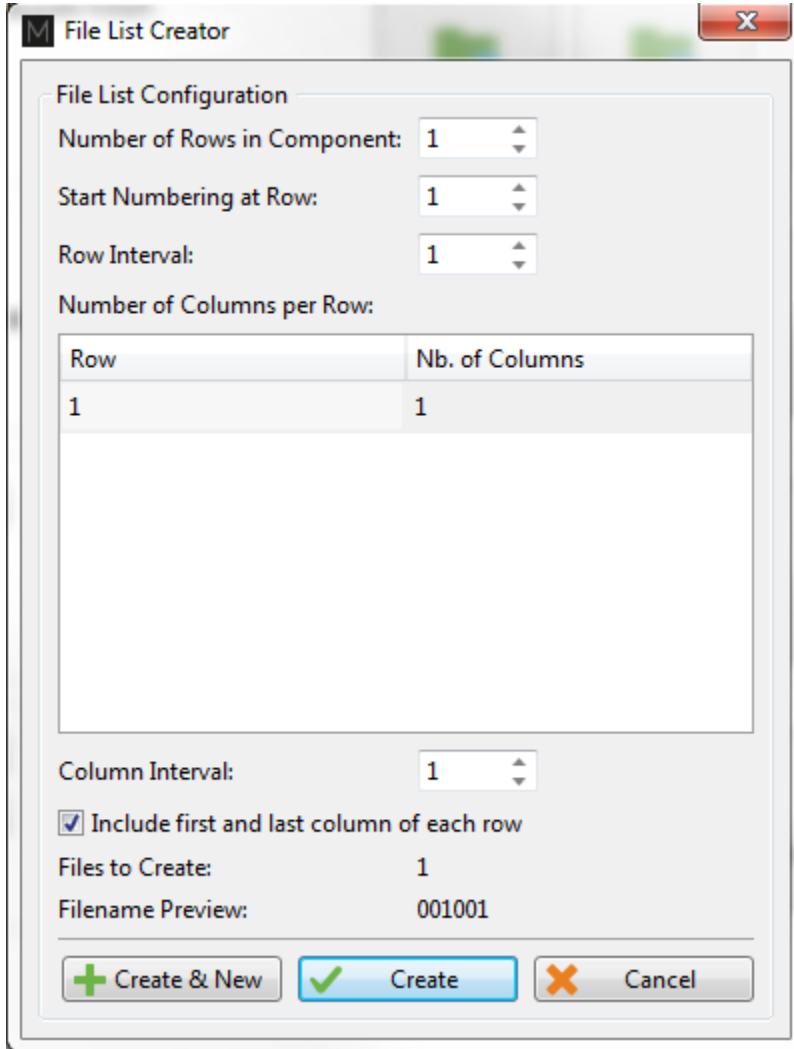

The same principles apply to the other file formats, except for the *Free format* option for which the file name(s) needs to be entered manually in the file name window of the Frontstage.

The tube list can also be imported from another project using the *Import List* button. The tube list file can be found in the Inspection folder. It is also possible to import a list created in Tubepro.

## PERFORMING AN ACQUISITION

1. If you are in the Backstage, move to the Frontstage by clicking on *Start/Resume* button.
2. Click on the *Connect* button under the *Instrument* tab. This will open the *Instrument configuration* page. Click on the line showing the instrument to which you want to connect and then click *Connect*.



Note: Your Ectane firmware version may not match the version of Magnifi you are using. If this is the case, a red and white X icon will be shown in the *Status* field of the *Instrument connection* window. To download a matching version into your Ectane, click on the *Config.* button and then click the *Send firmware to the instrument* button of the *Instrument configuration* window.

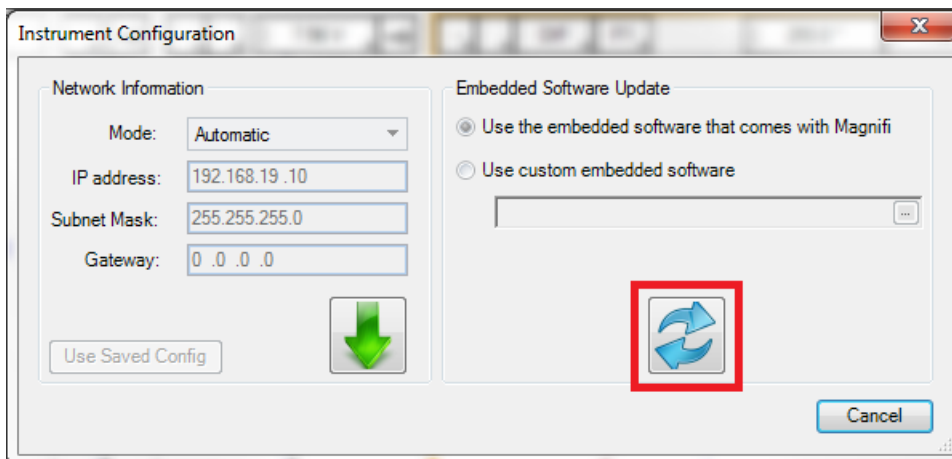
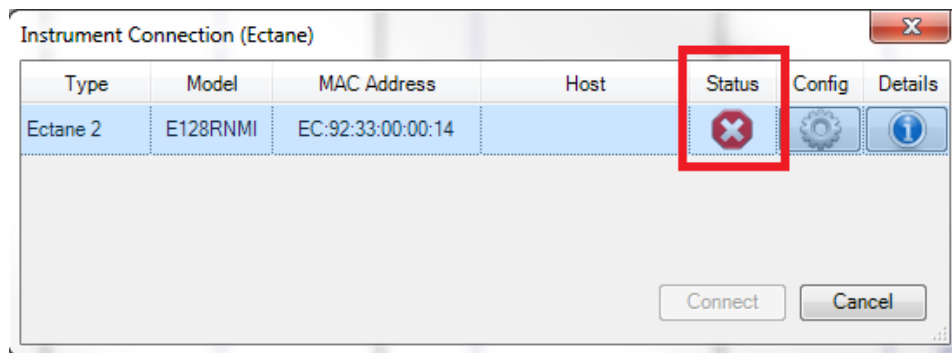

Two acquisition modes are available in Magnifi: *Setup Mode* and *Acquisition Mode*. *Setup Mode* is used to scan your calibration tube and make the necessary adjustments on your setup without saving the data automatically. The acquisition mode is used for the inspection. In this mode, the software automatically saves the acquired data using file names based on the tube list.



- For the calibration phase, go to *Setup Mode* by clicking on the *Setup Mode* button under the *Home* tab. This mode is active when the *Setup Mode* button is grayed.

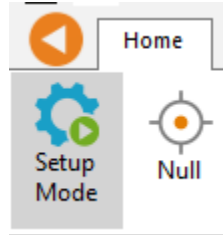

- Plug the NFA probe on the Ectane 160-pin connector.
- Bring the probe head in a clear area in your standard and balance the probe by clicking on the *Null* button under the *Home* tab, or press F6 on your keyboard.
- Push the probe head all the way through the tube so that it exits the tube.
- Start the acquisition by clicking on the *Acquire* button under the *Home* tab or by pressing the F2 on your keyboard.
- Pull the probe at approximately 12"/s (300 mm/s).
- When it's done, press the *Stop* button or F2 again on your keyboard.

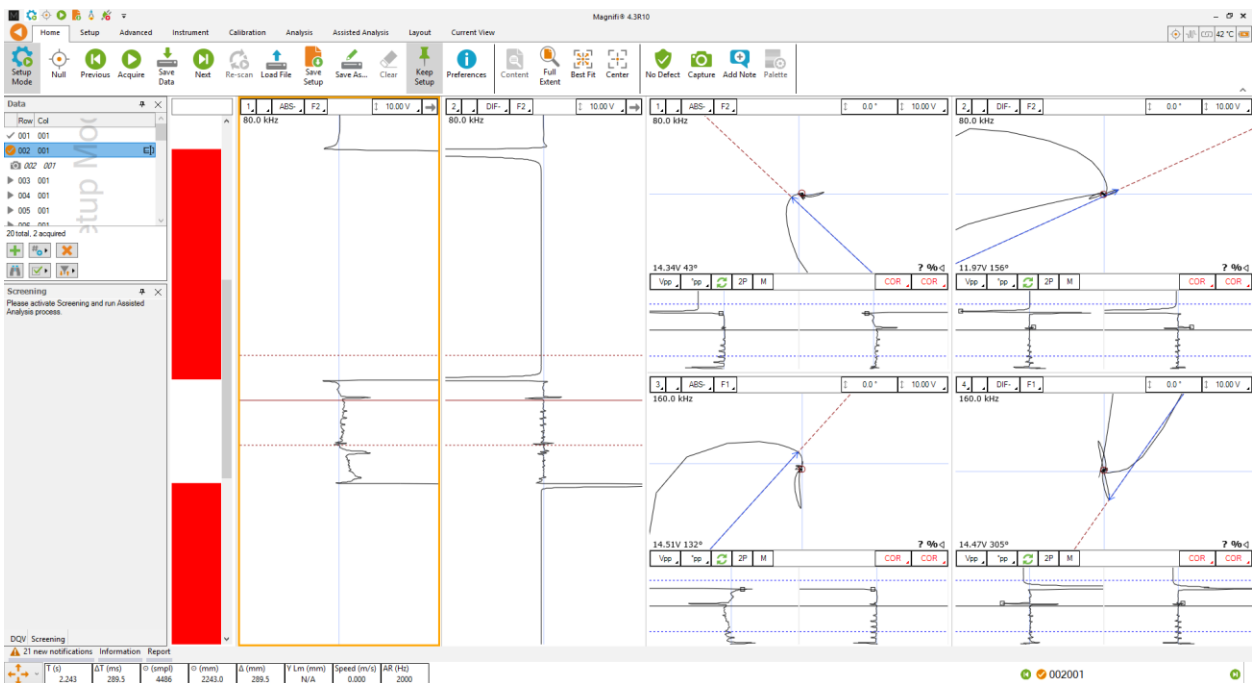

## VISUALIZING THE DATA

Multiple options are available to select your data and to measure it. The following describes useful functions to do so:

### DISPLAYED CHANNEL

There are four buttons at the upper right corner of the C-Scans, Strip charts and Lissajous windows. These buttons are used for the channel selection.

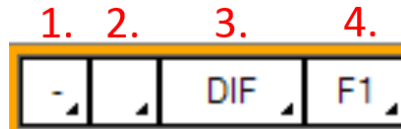

1. Links Strip charts and Lissajous to the same channel. For instance, if a Lissajous and a Strip chart are both set to 1, setting the Lissajous to DIF-F1 will also set the associated Strip chart to this channel.

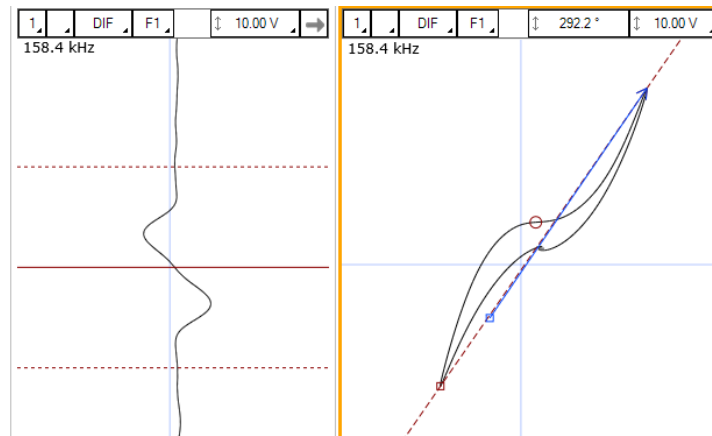

2. Clicking on the corner with the black triangle gives the list of available channels. Click on the desired channel to select it. Right-click or Left-click on this button to switch to the following or previous channel in the list.

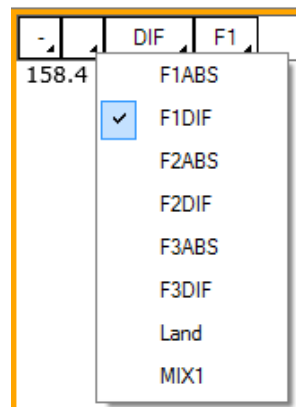

3. Same principle as 2., but for the type of channel only (absolute or differential)
4. Same principle as 2., but for the frequencies only

## STRIP CHARTS AXIS ORIENTATION

The Strip charts are projections of the Lissajous on the vertical or horizontal axis. To switch from one axis to another, click on the box showing an arrow at the upper right corner of the Strip chart.



## ZOOMING

On the strip chart/or on a C-scan, hold the right button of your mouse and drag on the zone of interest to zoom in this section. This operation can be done in both axis for the C-scan.

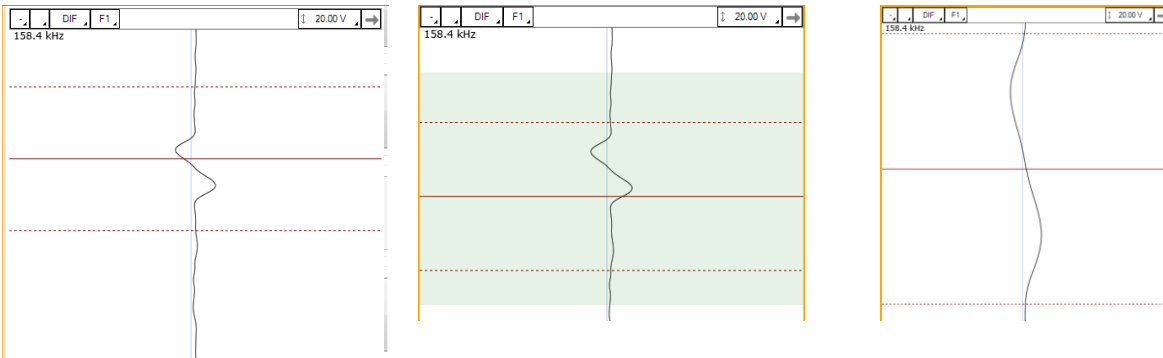

To zoom out, right-click on the Strip chart and select *Previous Zoom* or *Full Extent*.

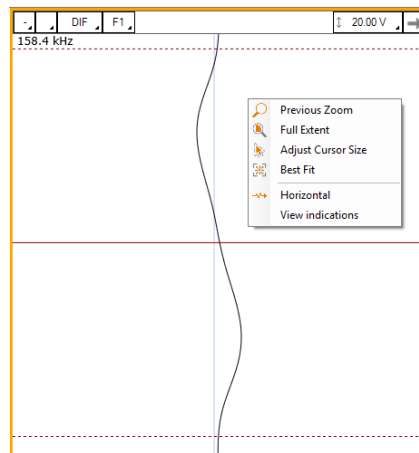

## ADJUSTING THE CURSOR LENGTH

On a Strip chart, the cursor is divided by 3 lines. The dotted lines represent the limit of your cursor and the full line is the center of what you have selected.

Only the portion of data between the dotted lines will be shown in the Lissajous.

To adjust your cursor length, hover your mouse over the dotted line, and click and drag the left mouse button. This will adjust the 2 dotted line symmetrically. To adjust only one dotted line, do the same operation, but with the right button of your mouse.

## ADJUSTING THE SCALE

The scale of a window (Lissajous or Strip chart) can be modified by clicking on the scale button with the left button (decrease scale) or the right button (increase scale) of your mouse.

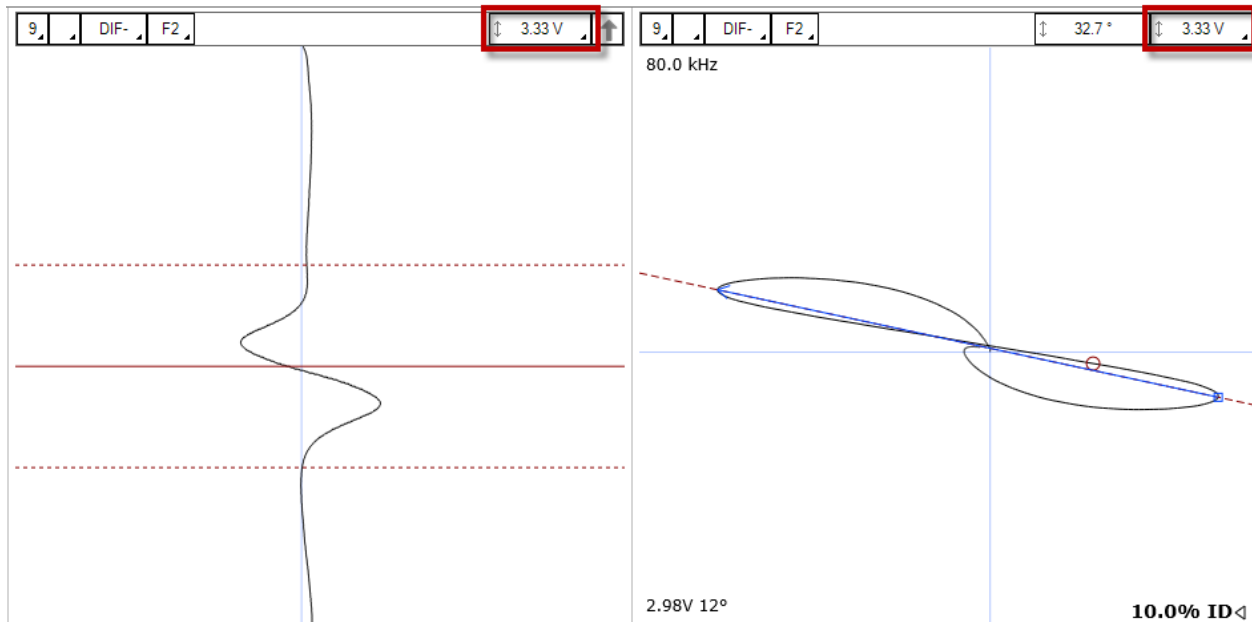

Another way to modify the scale is to click and drag (up or down) the right button of your mouse on the scale button.

## MEASUREMENT METHOD

The buttons at the lower left corner of the Lissajous windows are used to select the measurement method. A short description of the measurement methods can be found in the above calibration section of the setup wizard.



1. Clicking on the corner with the black triangle gives the list of measurement method for the amplitude of the signal. Click on the desired method to select it. Right- or left-click on this button to select the next or the previous method in the list.
2. Same as 1., but for the phase measurement.
3. Remove 180° to the measured phase. This option can be used if the software doesn't measure the phase with the right orientation.
4. Take the same two points in time to take the measurement in the other Lissajous
5. Allow a manual measurement of the signal. Click and drag the left button of your mouse to draw a vector on your Lissajous.

## LISSAJOUS ROTATION AND PANNING

The signal in a Lissajous can be rotated by holding CTRL on the keyboard while holding the left button of your mouse and dragging it around the rotation axis. Note that this operation cannot be performed on the raw channels since these channels have no gain or rotated applied, by definition. Also, rotating the signal will affect your calibration. If you perform this operation, make sure to recalibrate afterwards.

The origin point can also be moved by holding the left button of your mouse on the Lissajous background and by dragging it in the desired direction.

## DATA CENTERING

To center the data in the different windows, put your cursor at a point where you want the data to be centered and use the spacebar on the keyboard. Calibration and sizing curves

## CALIBRATION AND SIZING CURVES

### SLEW

The NFA probes include bobbins that generate absolute channel(s). It also includes a set of pancake coils that generates C-scan(s). Since the bobbins and the pancake coils are not physically located at the same position on the probe, there is a time delay between the channels (coils) and the C-scan (pancakes coils). To bring all the signals at the same position, the bobbin channels can be shifted in time to match the C-scan. This process is called *Slew* in Magnifi.

To Slew:

1. Click on the *Slew* button that can be found under the Calibration tab.

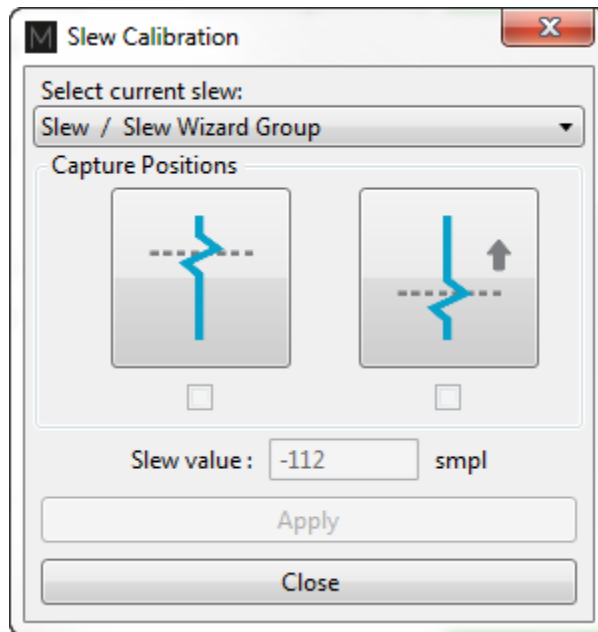

2. Place your cursor over a flaw in your C-scan.
3. Click on the button at the left in the *Slew Calibration* window. This will set the reference point at which the channels will move.
4. Place your cursor over the same flaw but on the absolute channel.
5. Click on the button at the right in the *Slew Calibration* window.
6. Click on *Apply*.

Note that this process will move the channel(s) by a constant number of samples. Therefore, a probe pulling speed that was not constant won't have a data alignment that is valid throughout the hole scan.

## CALIBRATION

The following section describes how to calibrate your probe.

1. Go to the *Calibration* tab and click on the *System* icon.
2. Select Channel in the calibration window.
3. In the Strip chart, select the signal to calibrate and adjust the cursors to see only the desired signal.

Note: The system calibrates the signal with a measurement method that is defined in the calibration part of the setup (previous step). It is recommended to read the data with the same method as the system when you select your calibration point. This will allow you to see what the system is using to make its calibration. If, for some reason, the measurement is not taken properly, you may be able to readjust your cursor to have the right measured values.

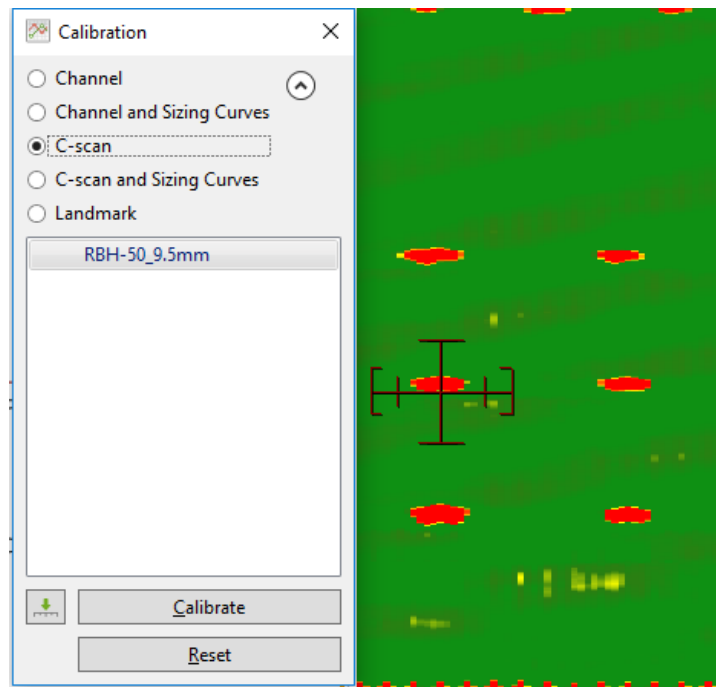

4. Select the signal name in the list.
5. Click on the green arrow button to associate the measured signal to the calibration point.
6. If more than one calibration point is present in the list, repeat steps 3, 4 and 5 for each one.
7. When all your calibration points are check-marked, click on the *Calibrate* button.

# SIZING CURVES

The following section describes how to build your sizing curves.

1. Go the calibration tab and click on the Sizing curve button.
2. Select Channel and Sizing Curves in the calibration window.
3. Select the signal in your Strip chart and adjust the cursors to see only the desired signal.

Note: The system calibrates the signal with a measurement method that is defined in the calibration part of the setup (previous step). It is recommended to read the data with the same method as the system when you select your calibration point. This will allow you to see what the system is using to make its calibration. If for some reason the measurement is not taken properly, you may be able to readjust your cursor to have the right measured values.

Also, when points are entered in the sizing curves, the interpolated value is displayed on the Lissajous to show the defect size. To have the correct interpolated point, the measurement method also needs to be the same as the one used for the sizing curve. To change the measurement method, click on the icons at the bottom left of the Lissajous.

1. Select the signal name in the list.
2. Click on the green arrow.
3. Redo the previous steps for all the other indications in the list.
4. Click on the Calibrate button.

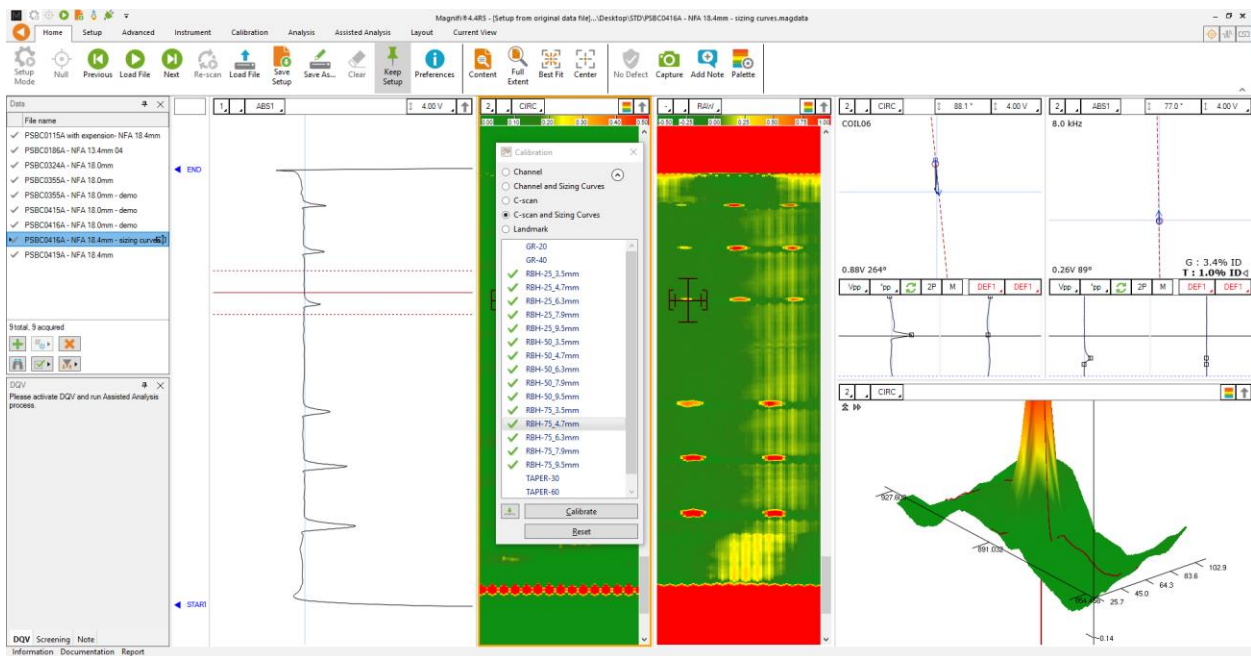



## LANDMARKS

The following section describes how to calibrate your landmarks.

Go to the calibration tab and click on the Landmark icon. Calibrate the landmarks shown in the *Landmarks* window the same way as you calibrated the sizing curve(s) points. You can use the *Land* channel to do so. The positions of TS1 and TS2 are described in the *Landmark* window in the *Setup* tab (TS2 is the far side tubesheet, that is, the first one encountered during data acquisition; TS1 is the nearside tubesheet).

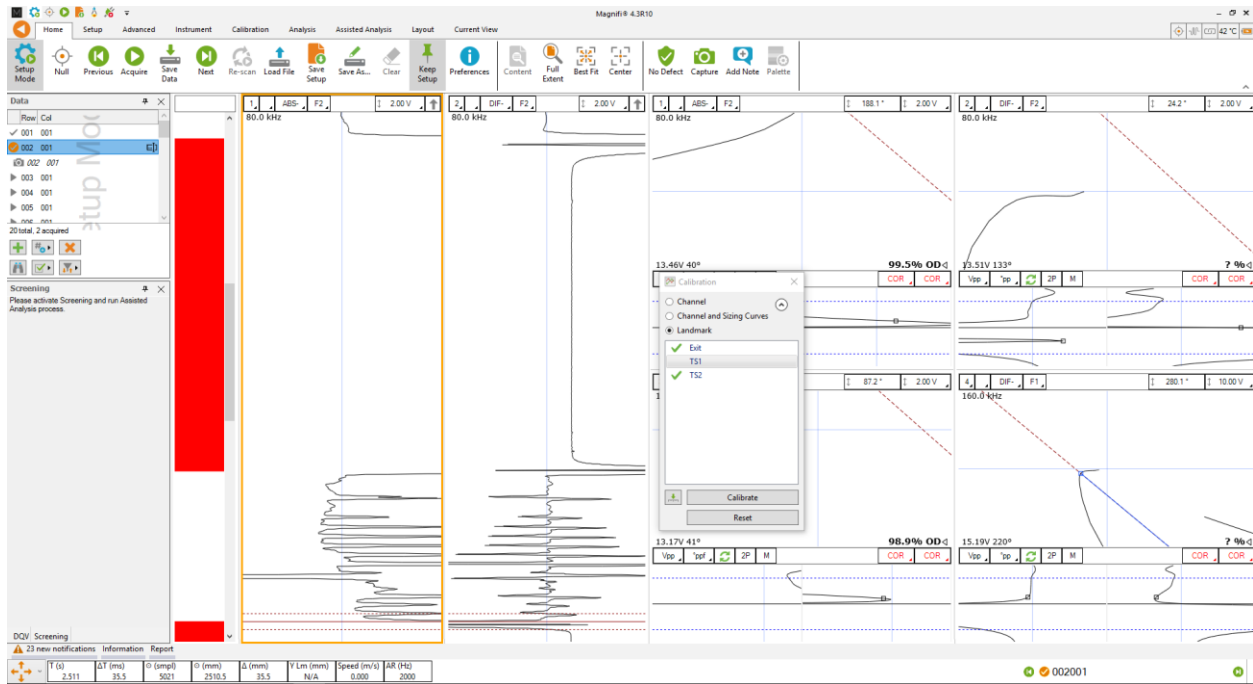

Once the landmarks are calibrated properly the system should be able to recognize them automatically.

Note that in order to calibrate the default *Exit* landmark, a datafile that includes the probe exit at the far end of the tube is needed.

## SAVING YOUR SETUP

Once all your setup adjustments are done, you can save your setup by clicking on the *Save Setup* button under the *Home* tab. The displayed window will allow you to give an appropriate name to your setup and to save it at the desired locations. The save location is, by default, your inspection file.

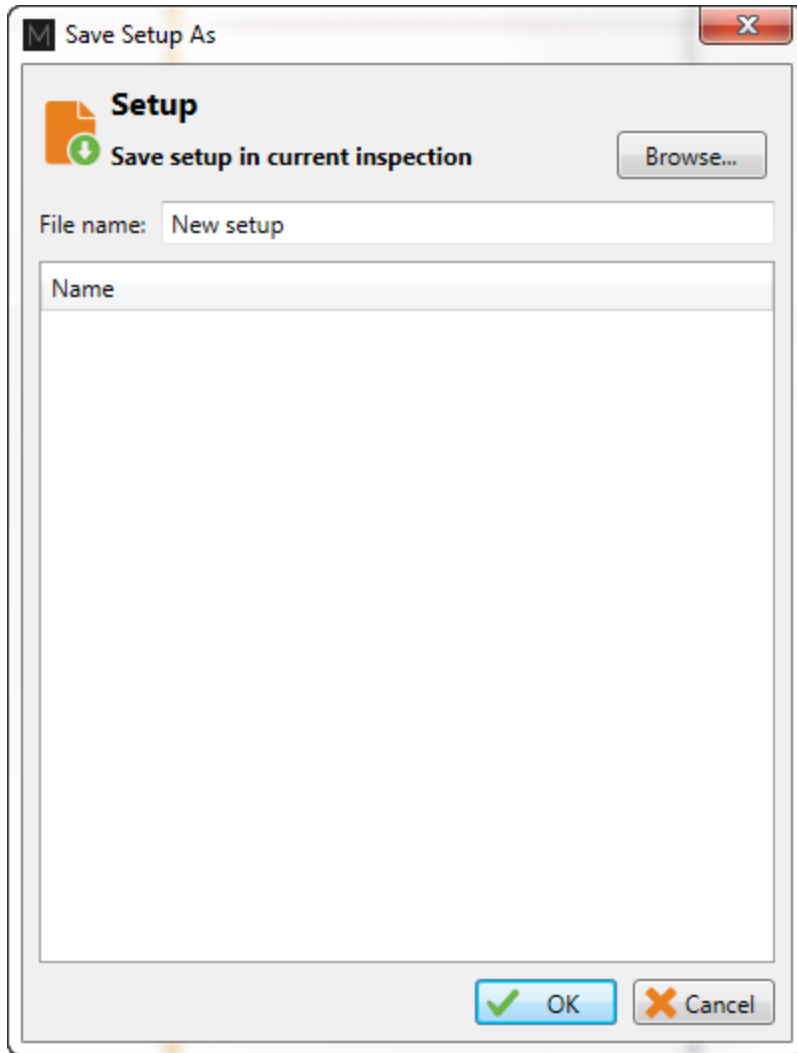

You can also save the data of your calibration standard by clicking on the *Save As* button under the *Home* tab.

### STANDARD ACQUISITION

The following section describes how to perform an inspection.

1. Connect Magnifi to the instrument.
2. Enter into *Acquisition Mode* by clicking on the *Setup Mode* button under the *Home* tab. *Acquisition Mode* is activated when the *Setup Mode* button is not grayed.
3. Plug the NFA probe into the Ectane 160-pin connector. The orange dot on the connector must be aligned with the orange dot on the Ectane.
4. Bring the probe head to a clear area in your standard and balance the probe by clicking on the *Null* button under the *Home* tab, or press F6 on your keyboard.
5. Push the probe all the way through the tube until it exits the far end.
6. start the acquisition by clicking on the *Acquire* button under the *Home* tab or by pressing the F2 on your keyboard.
7. Pull the tube probe towards you at a constant speed until it exits the tube.
8. When finished, press the *Stop* button or again F2 on your keyboard.
9. Repeat steps 4,5 and 6 for all the tubes to inspect in your bundle.

### MANUAL SEQUENCE

An inspection can also be done by using the manual sequence. This feature is based on the landmarks and can trigger the acquisition start/stop and the data recording automatically. At least two landmarks are needed to use this feature. These landmarks can be created by using the Landmarks button under the SMART Setup tab.

To set the manual sequence:

1. Click on the *Manual Sequence* button under the *Calibration* tab.
2. If a warning message is shown in this window, change the parameters until no warning is shown. The system will progress through the different windows to guide you.
3. Click on *Settings ...*

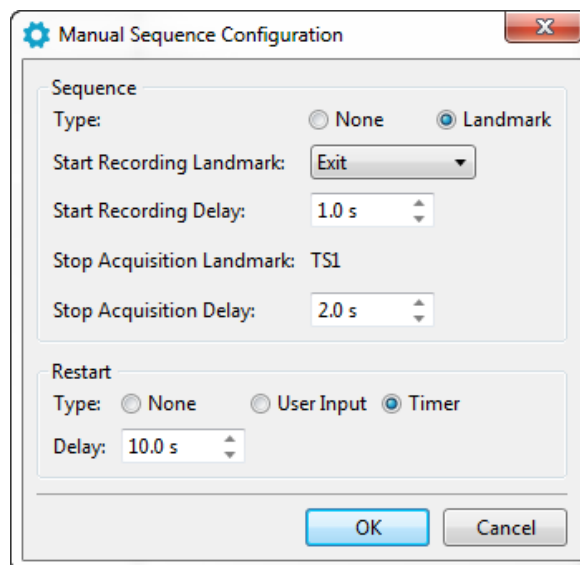
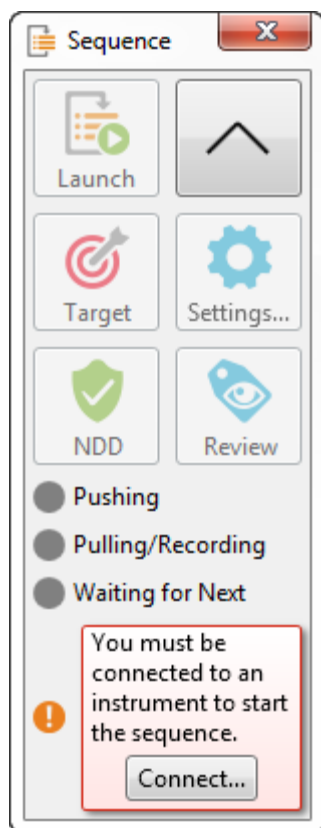

4. Select *Landmark* in the *Type* section.
5. In the drop-down menu, choose the Landmark that will initiate the data recording. If you keep the default landmarks, you can select the *Exit* landmark that will be triggered when the probe goes out of the tube when the probe is pushed.
6. You can enter a delay to start the acquisition after the first landmark is detected (*Start Recording Delay*) and a delay to stop the acquisition when the last landmark is detected (*Stop Acquisition Delay*).
7. Two options are available to restart the acquisition: The user can either push a button or use a timer. Select the desired option in the *Restart* section.
8. Click on *OK*.

To use the manual sequence:

1. Connect Magnifi to the instrument
2. Enter into *Acquisition Mode* by clicking on the *Setup Mode* button under the *Home* tab. The *Acquisition Mode* is activated when the *Setup Mode* button is not grayed.
3. Plug the NFA probe into the Ectane 160-pin connector.
4. Bring the probe head to a clear area in your standard and balance the probe by clicking on the *Null* button under the *Home* tab, or press F6 on your keyboard.
5. Open the *Sequence* window by clicking on the *Manual Sequence* button under the *Calibration* tab.
6. Put your probe in the tube to inspect and click on the *Launch* button. This will start the data acquisition.

7. Push the probe until it exits the far end of the tube. If set correctly, , Magnifi will recognize the landmark and this will initiate the data recording.
8. Pull the probe towards you until it exits the tube. This will trigger the last landmark detection that will stop the data recording.
9. Acquisition restart:
  - a. If you selected *User Input* in the settings of the *Manual Sequence Configuration*, the system will wait for the user to enter information on the tube to restart the acquisition. Click on *NDD* or *Review*. This will add a tag to the inspected tube and it will restart the acquisition. Redo step 6, 7 and 8a. for all the tubes to inspect
  - b. If you selected *Timer* in the settings of the *Manual Sequence Configuration*, a *countdown will be triggered after the last tube acquisition was taken*. The acquisition will start after this time has elapsed. Repeat steps 6 and 7 for all the other tubes to inspect in the bundle.

When doing your inspection, you may encounter some tubes that can't be scanned completely. If this is the case, you won't be able to catch the landmark that triggers the data acquisition at the end of the tube. In this situation, you can click on the *Target* button in the *Sequence* window to start the data recording.

## DATA LIST MANAGEMENT

For each acquisition, Magnifi can automatically save a file using the file name defined previously in the *Tube list* section of this document. To do so, checkmark the *Automatic File Recording* option that can be found under the *General tab* of the *Preference* menu of the *Backstage*.

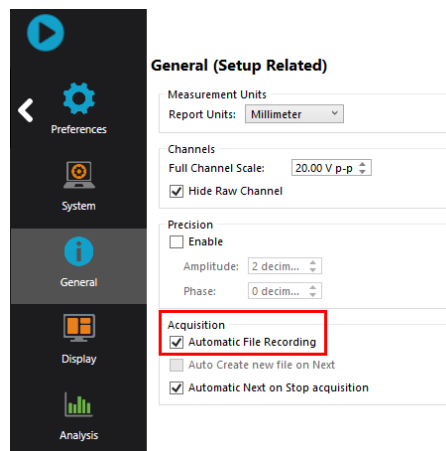

This list of tubes is shown in the *Data* window at the left of the Frontstage.

Data		✕
Row	Col	
▶ 001	001	☰
▶ 002	001	
▶ 003	001	
▶ 004	001	

4 total, 0 acquired

+
# ▶
✕
  
🔍
✓ ▶
🔧 ▶

A common practice is to rescan your calibration tube and balance the probe periodically. You can save this new calibration tube data by adding a new tube in your tube list (999 001 for example). Or you can go out of acquisition mode, scan your tube, and click on the *Save Cal As...* button under the *Calibration* tab to save your data. You can then go back to the *acquisition mode* to continue your inspection and to automatically save the acquired tubes in your bundle.

Once a tube has been scanned, the "play" icon next to the file name will be replaced with a checkmark icon.

You can rescan a tube by selecting its name in the list and by clicking on the *Rescan* button in the *Home* tab.

A tube name can be changed by right-clicking on its name and by selecting the *Rename* option.

## LOADING A FILE

1. First disconnect your computer from the Ectane by clicking on the *Disconnect* button under the *Home* tab.
2. You can load a file by double-clicking on the file name in the *Data* window. It can also be done by selecting the file in the list and by clicking on the *Load* button under the *Home* tab. Note that double-clicking on a tube when you are still connected to an instrument will initiate data acquisition.
3. You can open the next or the previous file in the list by clicking on the *Previous* or *Next* button of the *Home* tab.

The data files can be filtered by using the *Filter* button of the *Data* window.

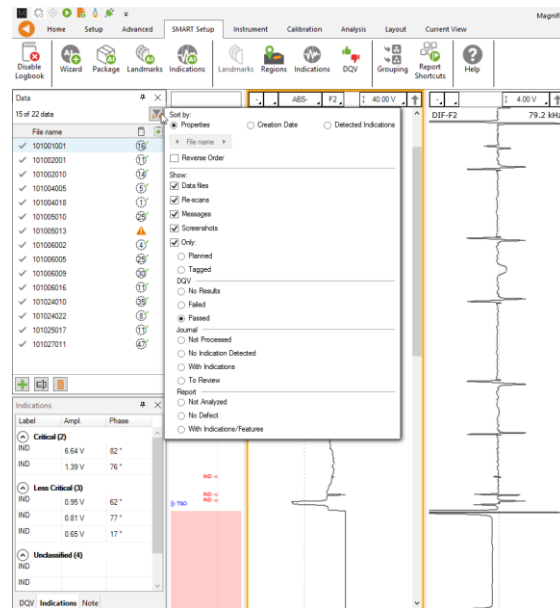

## REPORT

### INDICATIONS

The two (2) *Indication* buttons at the lower corner of the Lissajous windows can be used to add an entry to the report. These 2 buttons indicate the code that is associated with the defect being entered. Both buttons are identical, but can be set to different flaws.

To add an indication to the data:

1. Select the defect signal in the strip chart and adjust the cursor so that the signal in the Lissajous includes only the defect signal.
2. Then, click on the red triangle in the corner of the *Indication* button to select the type of defect to enter.
3. Click on the defect button to add an entry to the report.

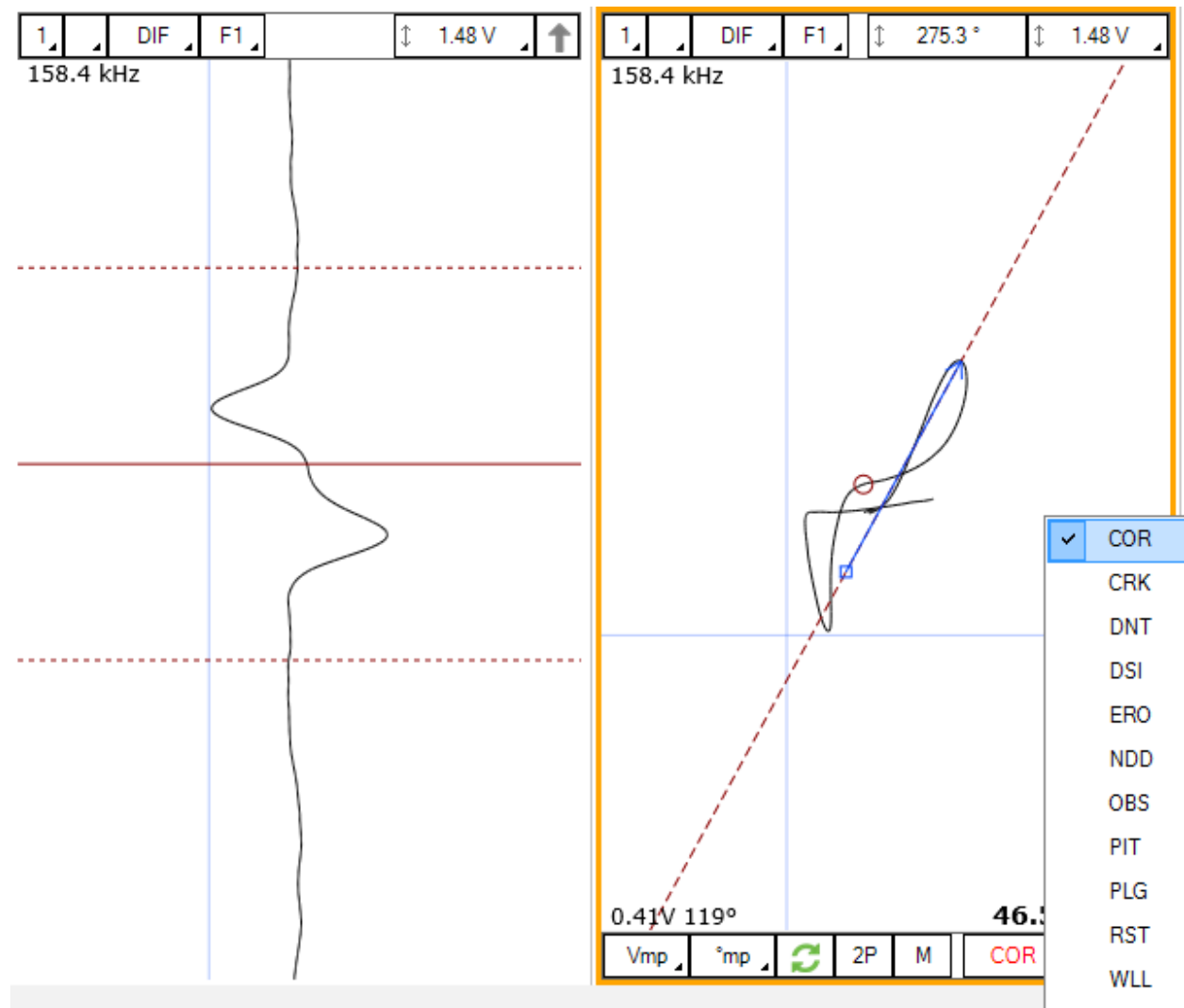



Report Entries can also be added with keyboard shortcuts. How to set up these keyboard shortcuts is explained in the SMART Setup section of this manual.

Indications can also be added to a tube to indicate, for instance, that it has no flaws or that it is plugged.

To add an indication to a tube:

1. Load the file
2. Click on the appropriate indication button available under the Analysis tab

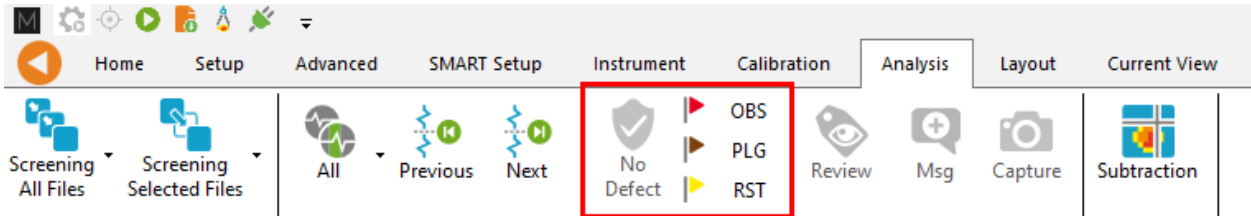

## REPORT TABLE

To access the list of indications entered:

1. Make sure that the Report option is selected under the Layout tab.

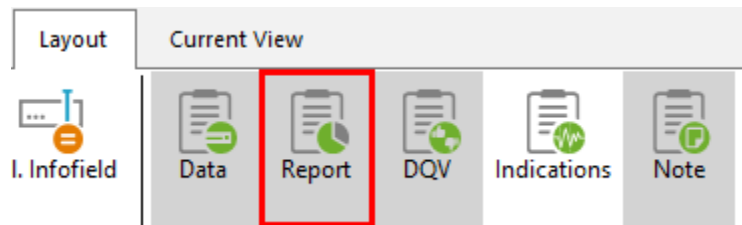

2. Click on the report ribbon at the bottom of the screen to make the list visible

The screenshot shows a table titled 'Report' with the following columns: Zone, Row, Col, Code, Size, Side, Ampl. (V), Angle (°), Channel/C-scan, Y pos. (mm), LMK Y pos., Offset Y pos. (mm), Y leng. (mm), and Comment. There are two rows of data, both with 'X' icons in the Comment column. The 'Report' tab is highlighted in the bottom status bar.

Zone	Row	Col	Code	Size	Side	Ampl. (V)	Angle (°)	Channel/C-scan	Y pos. (mm)	LMK Y pos.	Offset Y pos. (mm)	Y leng. (mm)	Comment
1	0	0		0.00		0.00	0		0.0		0.0	0.0	X
2	0	0		0.00		0.00	0		0.0		0.0	0.0	X

Entries in the report can be modified by changing the value in the table. You can also delete an entry by clicking on the X next to it.

## REPORT GENERATION

Magnifi can automatically generate a full report with the report table.

To generate this report:

1. Go to the *Backstage* by clicking on the arrow at the upper left corner of the *Frontstage*.

- Click on the Generate Report button under the *Report* section of the *General* tab.
- Choose your preferences and enter the required parameters. The *# of tubes in component* is used to show the percentage of tube in each category.

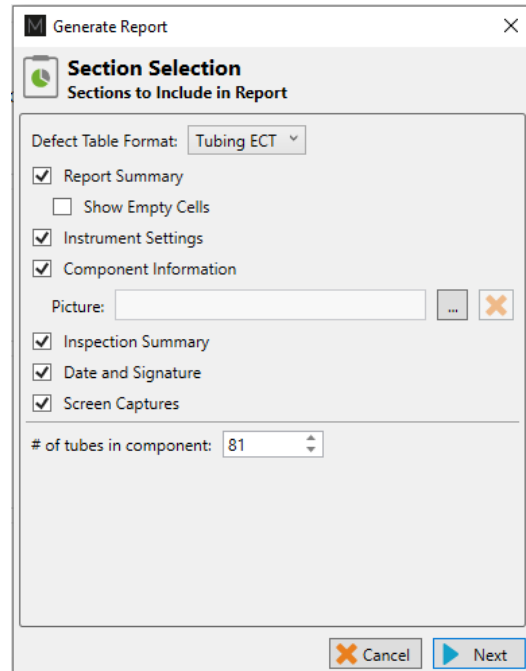
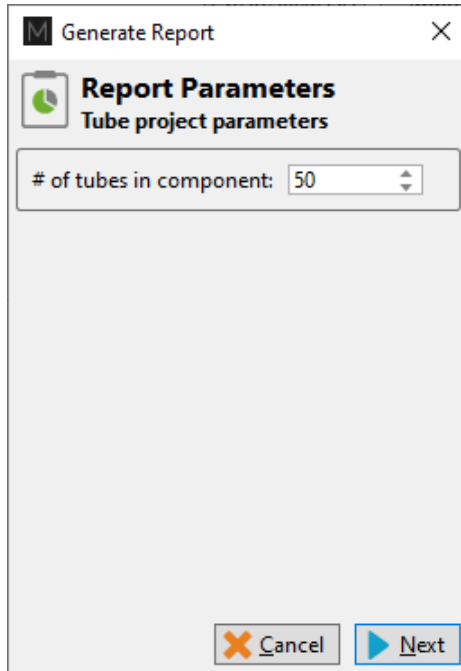

- Click Finish to generate the report.

Once generated, the report is saved as a .html file in the current Inspection sub-directory. It can be viewed using any regular web browser.

There is a “copy” button next to each element of the report such as tables and images. When clicking on it, the element will be copied to the clipboard. It can then be pasted to another file such as an Excel or Word.

Name	Frequency (KHz)	Drive (V)	Gain (dB)	Low Pass (KHz)	High Pass (Cnt)
R_ABS-F1	160.0	2.50	46.0	400	
R_ABS-F2	80.0	2.50	46.0	400	
R_ABS-F3	40.0	2.50	46.0	400	
R_ABS-F4	20.0	2.50	46.0	400	
R_DIF-F1	160.0	2.50	46.0	400	
R_DIF-F2	80.0	2.50	46.0	400	
R_DIF-F3	40.0	2.50	46.0	400	
R_DIF-F4	20.0	2.50	46.0	400	

The Print button, bottom right corner on image above, can be used to either print a paper copy of the whole report or to save it as a .pdf document. The PDF generator available with the current web browser will be used.

The screenshot shows the 'Analysis Report' interface for Magnifi. The main content area displays a table of channels with the following data:

Name	Frequency (MHz)	Drive (V)	Gain (dB)	Low Pass (MHz)	High Pass (MHz)
R_ABS-F1	160.0	2.50	46.0	400	
R_ABS-F2	80.0	2.50	46.0	400	
R_ABS-F3	40.0	2.50	46.0	400	
R_ABS-F4	20.0	2.50	46.0	400	
R_DIF-F1	160.0	2.50	46.0	400	
R_DIF-F2	80.0	2.50	46.0	400	
R_DIF-F3	40.0	2.50	46.0	400	
R_DIF-F4	20.0	2.50	46.0	400	

On the right side, there is a print menu with the following options:

- Imprimer: 4 pages
- Destination: Enregistrer au format f
- Pages: Tous
- Mise en page: Portrait
- Plus de paramètres

At the bottom right, there are two buttons: 'Enregistrer' and 'Annuler'.

The report logo can be modified by clicking on the *Select Company Logo* that can be found under the *System* tab of the *Backstage*.

The screenshot shows the 'System (Computer Related)' settings page. The left sidebar contains navigation options: Preferences, System, General, Display, and Analysis. The main content area includes the following settings:

- Measurement Convention:** ASME (selected), ASME Inverted, EDF.
- Measurement Units:** Metric (selected), Imperial.
- Readback:**
  - Do not display data during loading
  - Speed:** Actual Inspection Speed, Maximum (selected).
  - 'Keep Current Setup' Button Behavior:** Retain check state, Reset to checked after loading a data file (selected).
  - Setup Wizard Path:** C:\Users\daube.QTEC\Documents\Magnifi\Setup
- Automatic Features:**
  - Allow to save setup in original location
  - Ask to save setup when the first data file is recorded
- Logo:** A 'Select Company Logo' button and a preview of the 'eddyfi' logo.

The report table file in the *Inspection* folder can also be imported into other reporting software such as *TubePro*.

# MFL Application Guide

## MFL Probes



## INTRODUCTION

---

This document presents how to set up and calibrate the MFL probe with Magnifi on an Ectane test instrument using the Setup Wizard.

## EQUIPMENT

---

The MFL probes use a 19-pin connector that can be connected to an Ectane with the “ERMN” option.

The *Absolute*, *Differential* and *Trail* signal from the probe will provide Strip charts and Lissajous. Magnetic flux leakage technology gives a variation of amplitude only. The phase variation on the *Differential* channel is artificially built to help the user to identify the indications. The *Trail* signal is more sensitive to internal flaws and can help determine the flaw side in a tube.

From the following table, the best standard probe for your application can be selected.

Note that Eddyfi also offers custom products at diameter that are not shown in this table.

Table 12 – Probe diameter selection table

# PRBT-MFL-ADT-XXX-Nzz

TUBE OD		TUBE WT			DIAMETER			POLY		PROBE PART NUMBER	NOTES			
mm	in	BWG	mm	in	CODE	mm	in	CODE	LENGTH					
19.05	0.750	12	2.77	0.109	124	12.4	0.488	20	20m (65ft)	PRBT-MFL-ADT-124-Nzz	These probes offer less sensitivity to external defects, because the core sections of the probes are significantly smaller than the tube section. Sensitivity to internal defects remains very high.			
		13	2.41	0.095						138		13.8	0.543	PRBT-MFL-ADT-138-Nzz
		14	2.11	0.083	148	14.8	0.583							PRBT-MFL-ADT-148-Nzz
		15	1.83	0.072						162		16.2	0.638	PRBT-MFL-ADT-162-Nzz
25.40	1.000	16	1.65	0.065	170	17.0	0.669							30
		9	3.76	0.148						180		18.0	0.709	
		10	3.40	0.134	188	18.8	0.740							PRBT-MFL-ADT-188-Nzz
		11	3.05	0.120						194		19.4	0.764	PRBT-MFL-ADT-194-Nzz
		12	2.77	0.109	200	20.0	0.787							PRBT-MFL-ADT-200-Nzz
		13	2.41	0.095						230		23.0	0.906	PRBT-MFL-ADT-230-Nzz
		31.75	1.250	14	2.11	0.083	244							24.4
15	1.83			0.072	256	25.6				1.008		PRBT-MFL-ADT-256-Nzz		
38.10	1.500			10			3.40	0.134	290		29.0	1.142	PRBT-MFL-ADT-290-Nzz	
				11	3.05	0.120	302	30.2		1.189			PRBT-MFL-ADT-302-Nzz	
				12	2.77	0.109			315		31.5	1.24	PRBT-MFL-ADT-315-Nzz	
		13	2.41	0.095										
		14	2.11	0.083										
15	1.83	0.072												

The MFL calibration tube used in this document includes the following flaws:

- Internal 360° groove, 10% of wall loss
- External 180° groove, 40%,60% and 80% of wall loss
- OD Flat bottom hole (FBH) 40%, 60% and 80% depth
- Hole, 100% of wall loss

Other combinations of flaws can be used to calibrate the probe and to build sizing curves.

## PROJECT AND INSPECTION FILES

---

In this section, we will create a folder structure that will manage the saving location of your setup, data and report. This management is operated through the creation of a *Project*.

Magnifi suggests two levels of file. The first level is the *Project*. It is meant to include different inspections that are related in some way. For instance, it can include all the inspections done at a refinery shutdown and be named *Refinery\_Shutdown\_May\_2018*. The second level of the file is the *Inspection* folder. Inspection folders are saved in the project file. An inspection folder can include the data specific to the inspection of a tube bundle with a specific technology and could be named *SS316\_075x0.065\_ECT* for instance. This inspection folder groups the setup, the tube list, the data files and the Magnifi report.

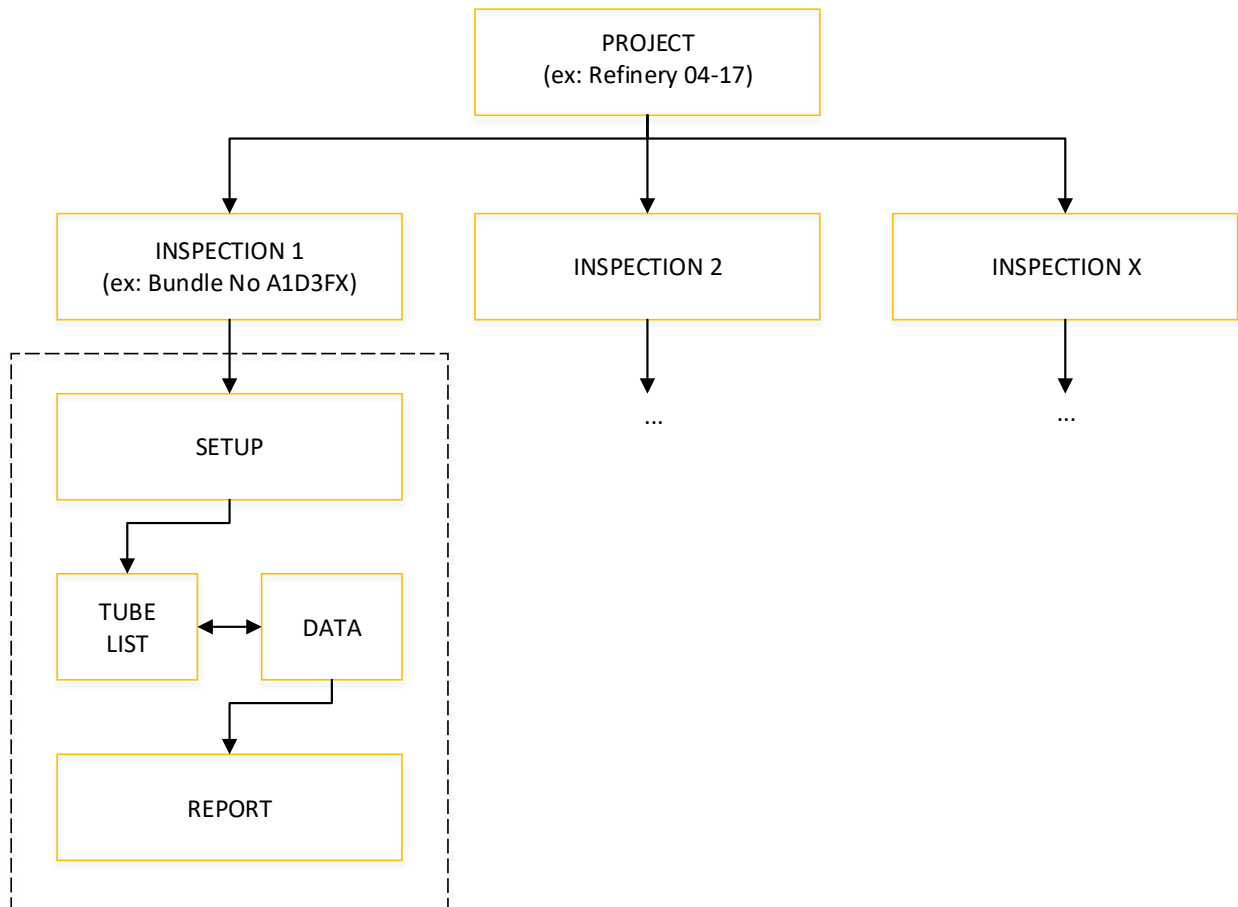



When you open Magnifi, the first page displayed is called the *Backstage*.



To create or open a project, click on *Open/Add Project* in the backstage. You can select an existing project/folder or you can create a new folder.

1. Create a folder by right-clicking on the location where you want to add your project file. Select *New, Folder* and enter the chosen name. You can then select the newly created folder and click on *Select Folder*.

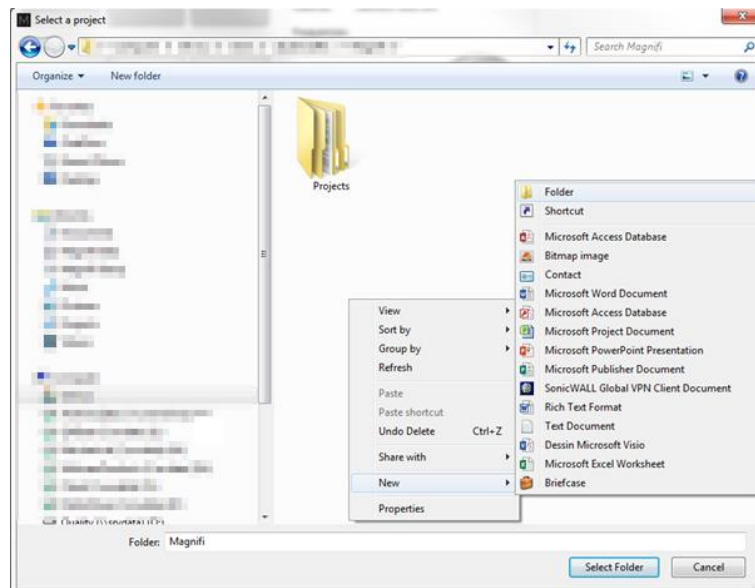

2. Click on *Add/Open Inspection* in the backstage, then click on *Add* and enter the name of your inspection.

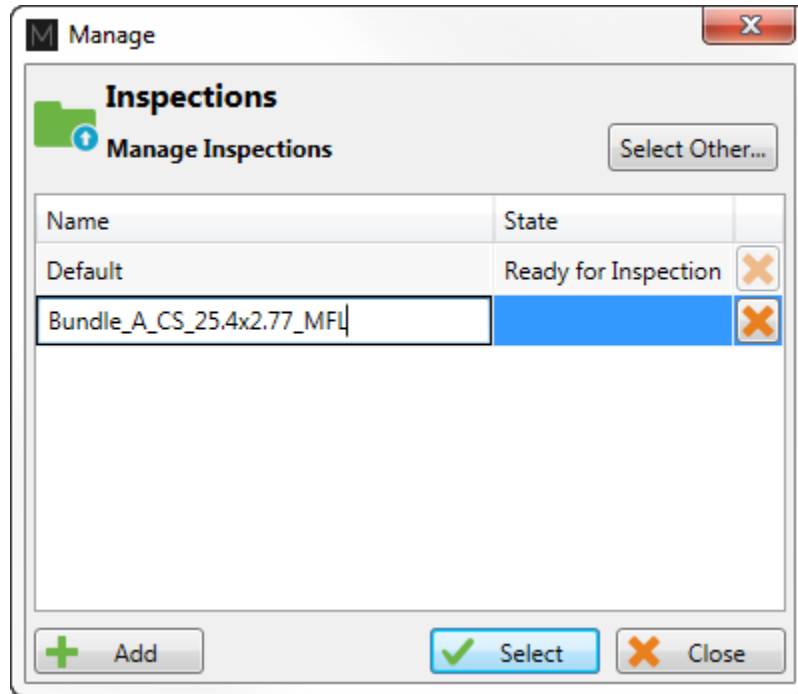

3. Click *Select*. This will define the position where the setup(s) and data will be saved.

## SETUP WIZARD

In this section, we will show how to create a setup using the *Setup Wizard* in Magnifi.

Before going further, you can change the measurement unit. To do so, click on *Preferences*. In the *System* tab, you can change the measurement units from metric to imperial and vice versa. For the metric units, you can choose to use meters, centimeters, or millimeters in the *General* tab. The default measurement for imperial units is inches. When finished, click on *Preferences* again to go back to the *General* window.

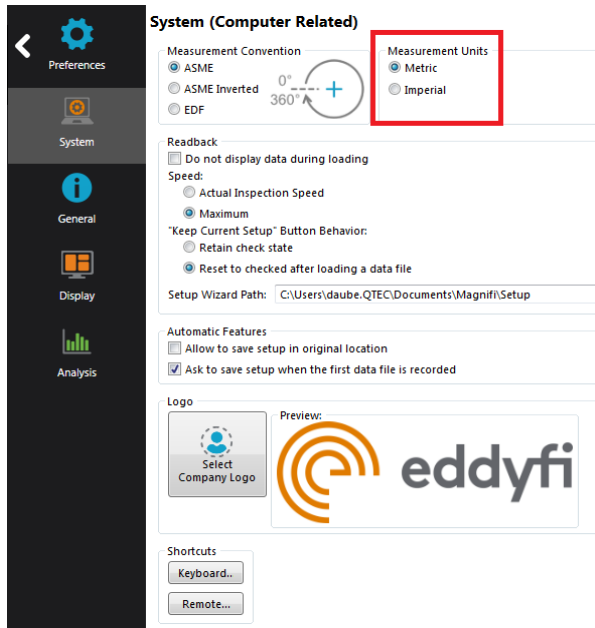

To create a new setup, it's strongly suggested to use the *Setup Wizard* process. Click on *Create Setup* to start the *Setup Wizard*.

## COMPONENT DEFINITION

The first page shown by the Setup Wizard is the Component Definition.

Click on the Material field to open the drop-down menu. Select the material of the tube to be inspected. If the material is not in the list, you can click on Manage... to open the List of Available Material window.

**New Setup Wizard**

### Component Definition

Configure the geometry and material of the component to inspect

Geometry:  Surface  Tube from ID

Application:  Generic  Air Conditioner

Material: Carbon steel

Resistivity: 21  $\mu\Omega\cdot\text{cm}$   
Permeability: 450  $\mu$   
Velocity: 5890.000 m/s

Wall thickness: 2.77 mm

BWG: 6 12 24

Outside diameter: 25.40 mm  
Length: 6000 mm

Note about selected material:  
ASTM: A178, A179, A192, A210, A214

To add a new material to the list, click on *Add*. A new line will appear in the list. Give the material a relevant name and set the material resistivity and permeability to its theoretical value. The ultrasound velocity is used to set IRIS parameters only, and it doesn't need to be set if an IRIS inspection is not performed on this material.

It's possible to add a note about the material to specify information such as its application or composition. When you are done, click *OK*.

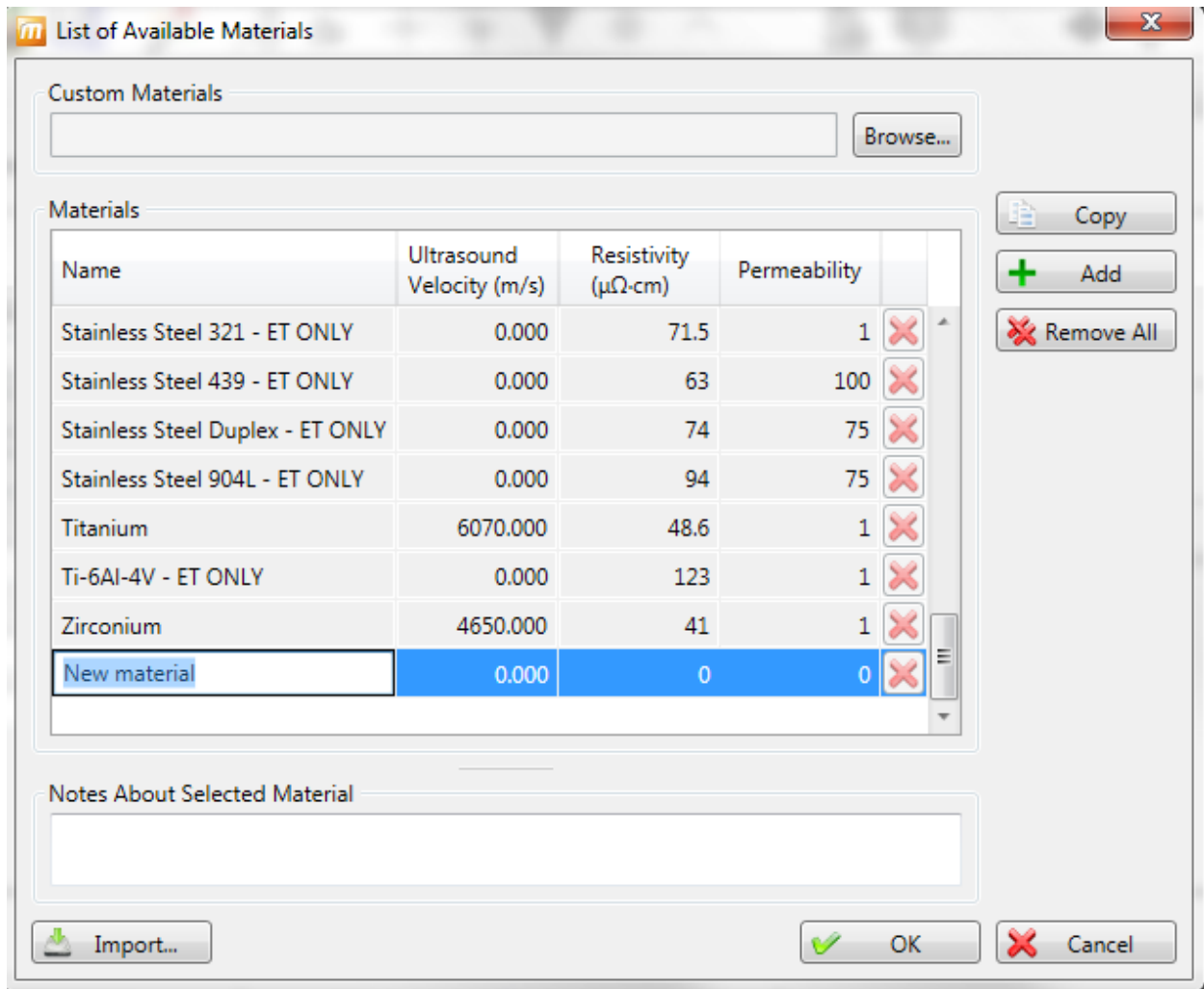

You will be back to the *Component Definition* window. If you added a new material, it will now be available in the material list.

Adjust the tube wall thickness by entering the value in the *Wall thickness* field or by moving the slider. Enter the tube's outer diameter and length.

These tube properties will help Magnify to suggest the optimal scan parameters.

Click *Next* when everything is set correctly.

## PROBE SELECTION

In the *Probe Selection* window, select the probe you will be using for your inspection.

You can filter the probe list by choosing an inspection technique from the *Technique* drop-down menu. More precise filtering can be done by using the *Model* drop-down menu. You can then select your probe by its catalog number (PRBT-MFL-ADT) and then click *Next*.

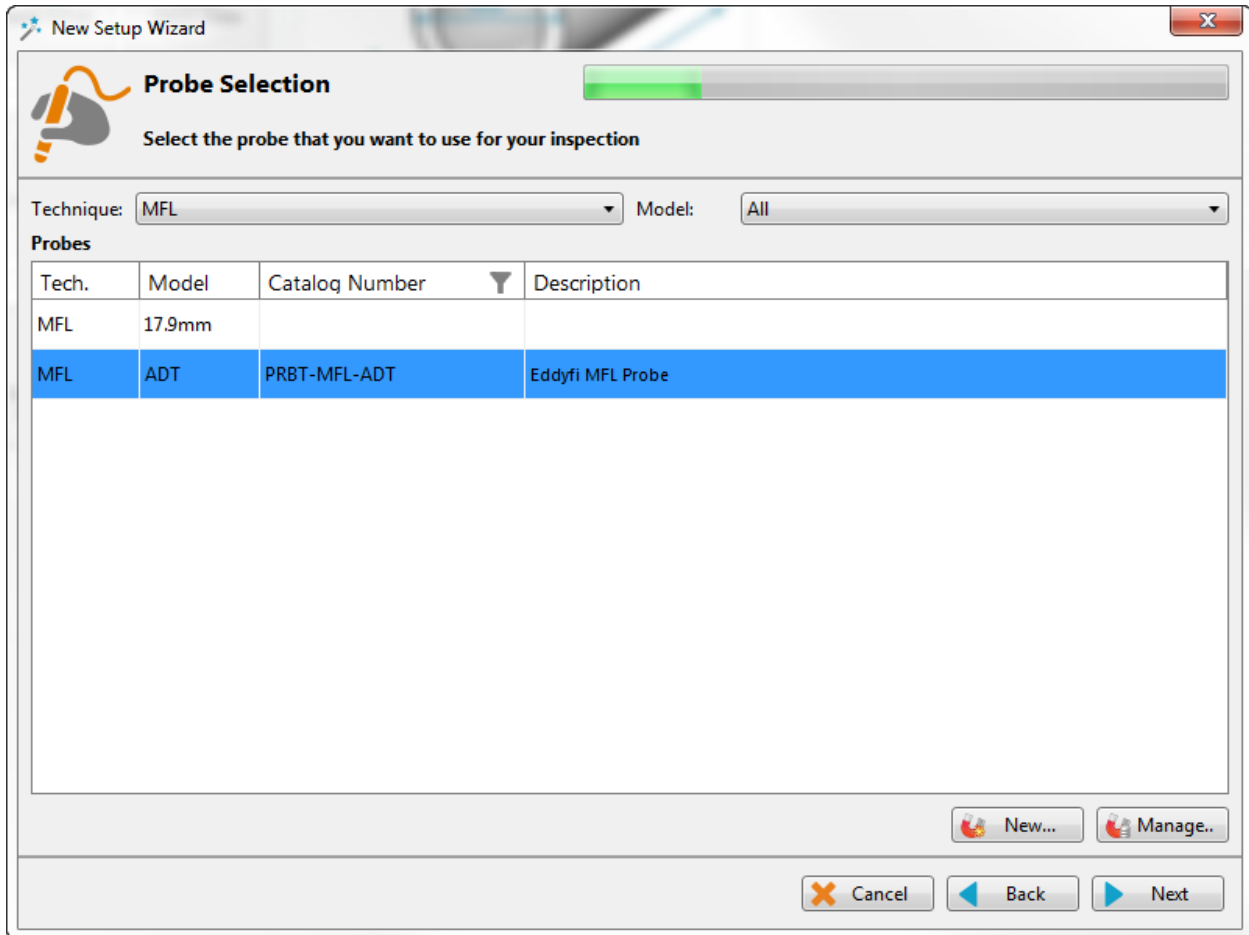

The screenshot shows a software window titled "New Setup Wizard" with a sub-window titled "Probe Selection". The sub-window has a progress bar and the instruction "Select the probe that you want to use for your inspection". Below this, there are two dropdown menus: "Technique:" set to "MFL" and "Model:" set to "All". A table titled "Probes" is displayed with the following data:

Tech.	Model	Catalog Number	Description
MFL	17.9mm		
MFL	ADT	PRBT-MFL-ADT	Eddyfi MFL Probe

At the bottom of the window, there are four buttons: "New...", "Manage..", "Cancel", "Back", and "Next".

## SCAN DEFINITION

The *Scan Definition* window is used to configure the axial position measurement method, the acquisition rate and the typical probe speed.

**Scan Definition**  
Configure the type of scan you will be performing with your probe

Scan: Single Pass

Main Scan Axis: Y Axis

Position from: Clock

Acquisition rate: 2000 Hz

Typical probe speed: 1000.0 mm/s

Acquisition Size: 600.000 s  Maximum

Cancel Back Next

The position along the tube can be defined by using either the internal clock of the system, or by using an axial encoder. If you use the internal clock, the default position will be given assuming that the probe is always pulled at the typical probe speed. If the typical probe speed is set to 1000mm/s, and the time since the acquisition began was 2 seconds, then the system will indicate a position of 2000mm. Using an encoder will give you the exact position of the probe. Note that the position can also be obtained by using the landmark tool, but this feature will be shown later.

The acquisition rate is the number of acquisition points taken per second. By default, the acquisition rate is set to 2000 Hz for MFL.

The axial resolution will depend on the combination of the acquisition rate and pulling speed. For an acquisition rate of 2000 Hz, the pulling speed needs to be less than 1m/s to have at least 2 points per millimeter. If you do not use a pusher-puller device such as the Probot, the pulling speed won't be constant. Therefore, it is recommended to target a lower pulling speed to be able to reach your axial resolution target. The typical probe speed should be set as close as possible to the real value. This will

help the algorithm that automatically detects landmarks (this will be explained in the Landmarks section). The recommended pulling speed for MFL is approximately 1000mm/s.

If you select to measure the position from Encoder, different fields will appear, and a second *Scan Definition* page will become available.

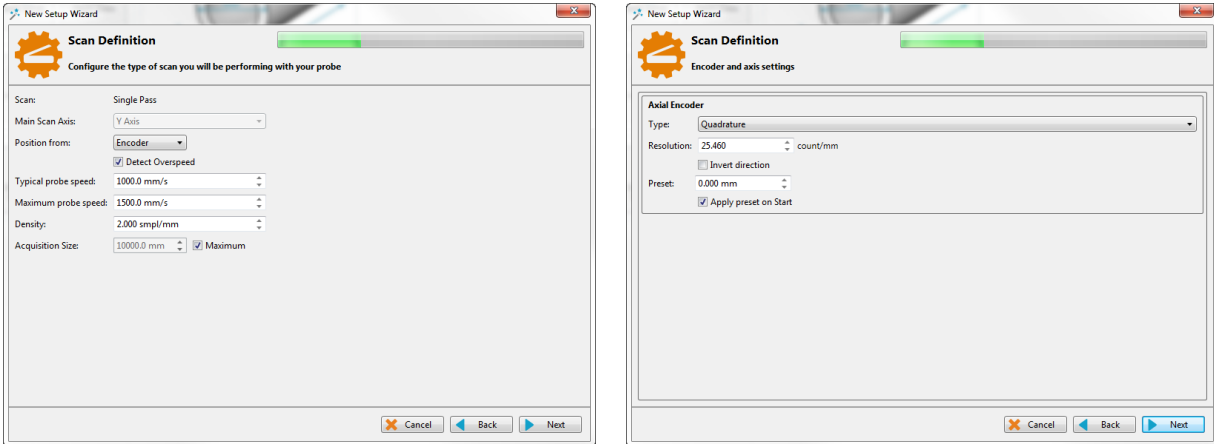

On the first page, the *Typical probe speed*, *Maximum probe speed* and the *Density* will have to be entered. The *Maximum probe speed* is the maximum acceptable speed for your probe and the *Density* is the number of acquired points per millimeter (axial resolution). These values will be used to set the acquisition rate and to optimize the acquisition processes used by the Ectane. Note that if your probe is pulled at a speed exceeding the *Maximum probe speed*, there will be gaps in data.

The second page includes the type of encoder and its resolution. A preset can also be specified if your acquisition doesn't start at 0 mm.

Click *Next* when you're finished.



## DATA DEFINITION

The *Data Definition* window is used to set the hardware gain for the different channels. It is important to set these parameters correctly before acquiring the data since they are driven by the instrument and cannot be modified during the analysis.

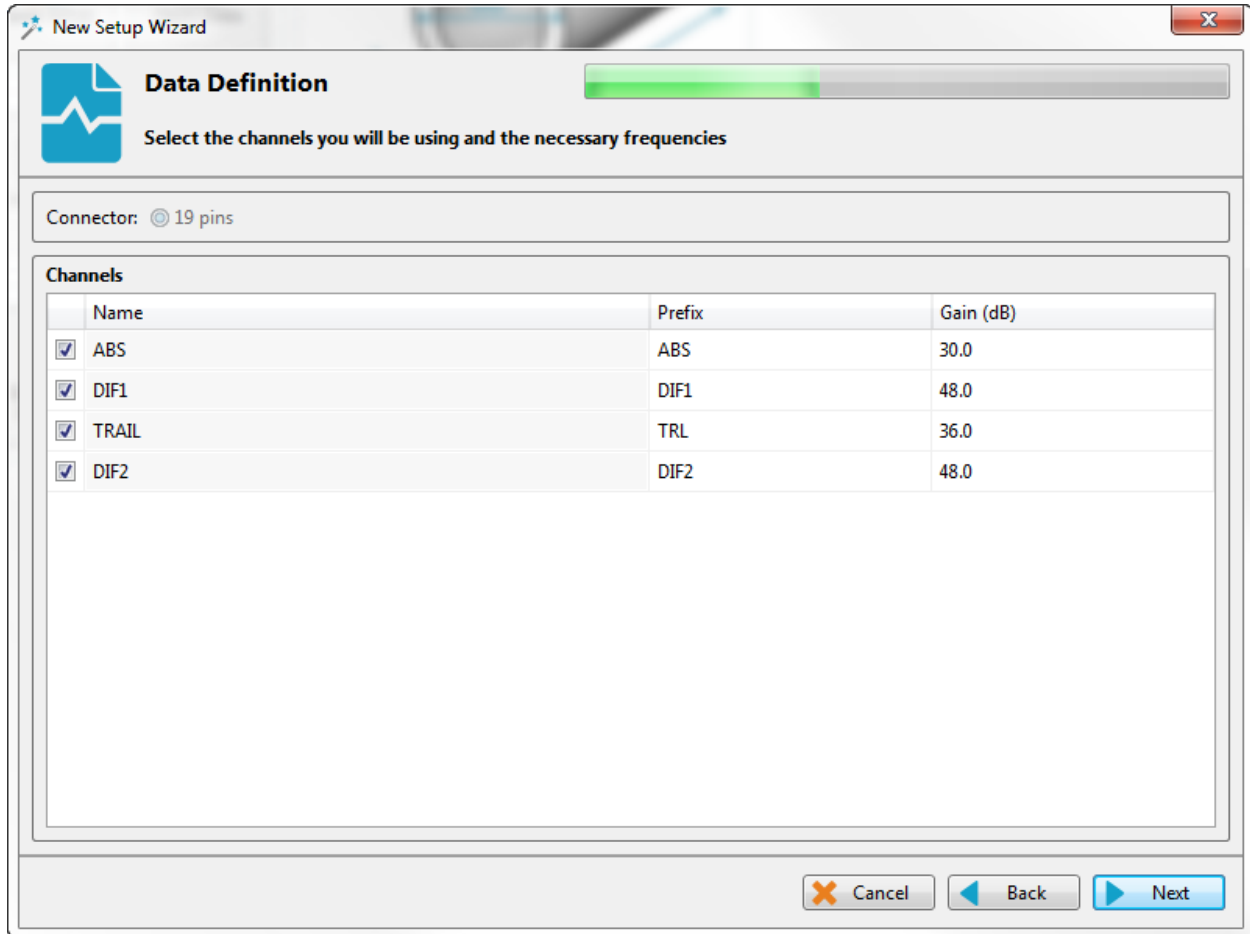

Click on *Next* when the desired parameters are entered.

The next window is used to build mixed channels. For MFL, a mix channel is built by default to create a differential signal shape on the differential signal. This part of setup is used for internal signal processing purposes only and it is not recommended to change it.

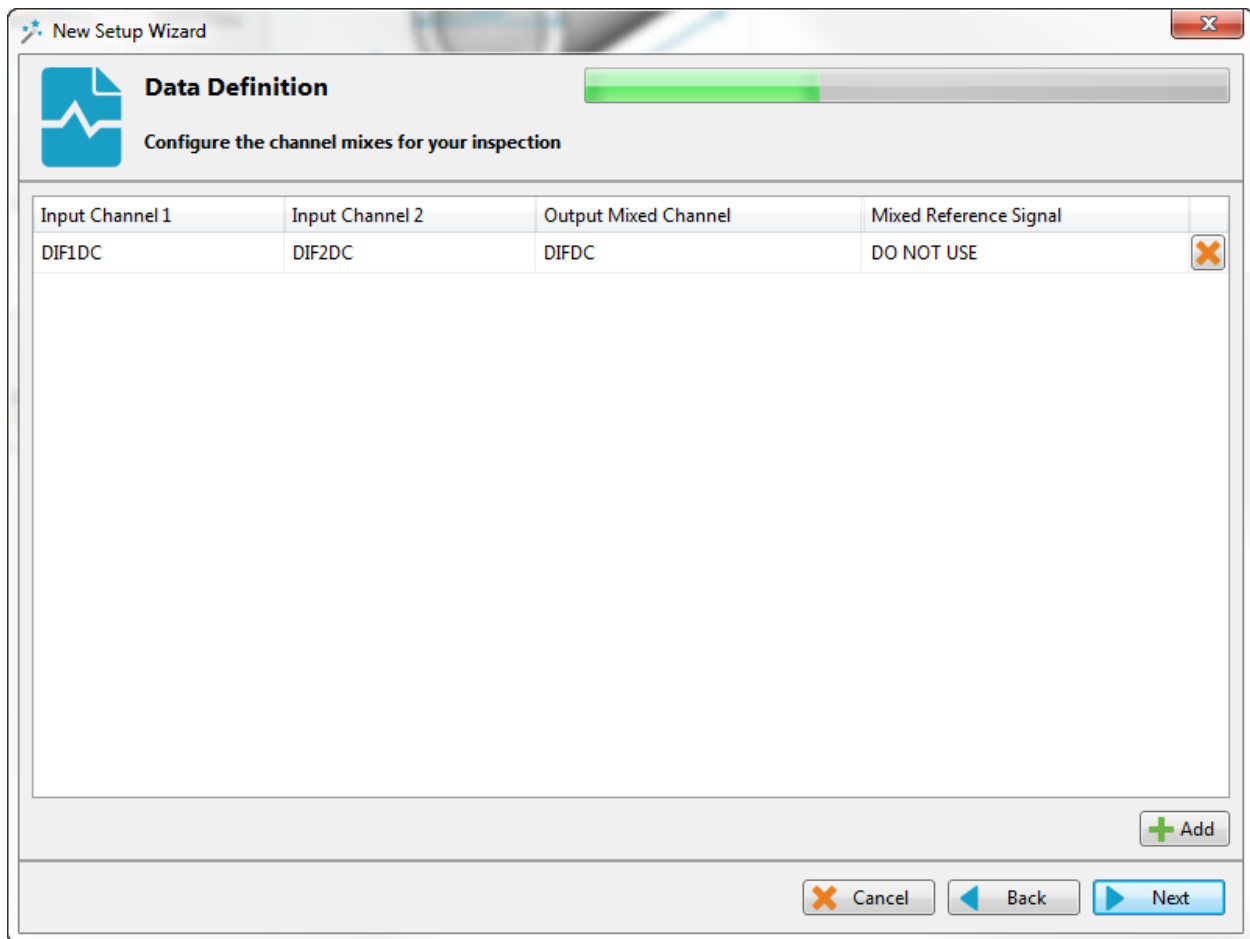

Click on *Next*.

## DATA PROCESSING

The *Data Processing* window is used to configure the signal processing to apply to the channels.

Note that the signal processing is done after the data acquisition. An inappropriate parameter choice can be changed without any problem during data analysis, while a wrong parameters choice for the data acquisition can mislead the analysis. It is possible to change the filters parameters after the acquisition, so it is always possible to fine tune the filters parameters during the analysis.

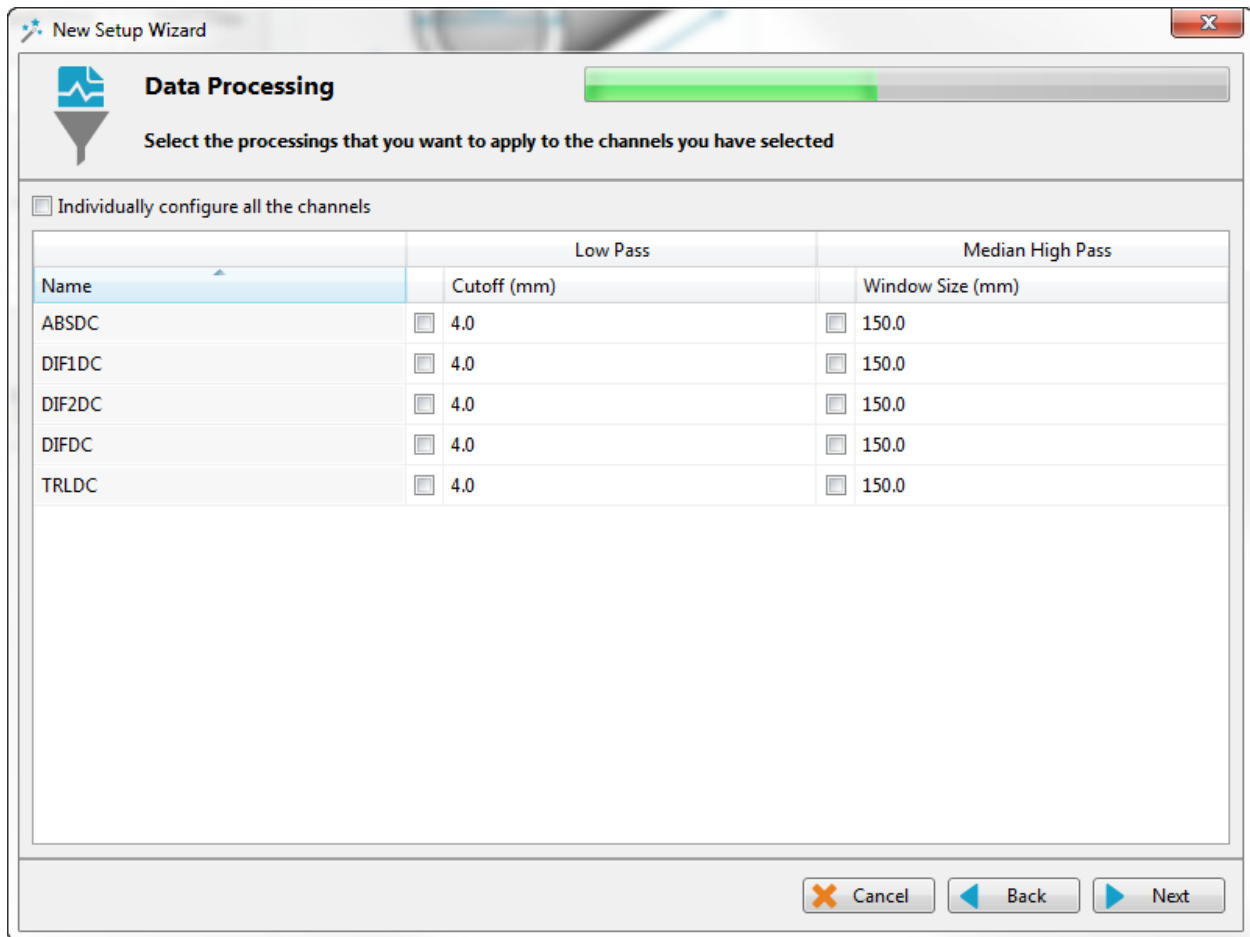

The low pass filter eliminates part of the signal that is above a certain frequency. As an example, it is useful when your defect signal has a lower frequency content than the background noise. In this case, using a filter will remove part of the noise without removing the defect's signals. This may help with data analysis. However, a cutoff frequency that is too high won't remove much noise, and a cutoff frequency that is too low will filter out the defect's signals.

The median high pass filter is used to filter out low frequency noise or drift such as lift-off variations of the probe within the tube, changes in material, geometry or thickness. As a rule-of-thumb, the width of the high-pass median filter should be set to at least three times the axial length of the longest flaw that may be encountered. Data should be examined in both its filtered and unfiltered states. It is important to keep in mind that the median high-pass filters can distort phase. More information about median filters for NDT analysis can be found on Eddyfi's blog.

Click *Next* when you are done.

## CALIBRATION POINTS

The *Calibration Points* page is used to define the points in your calibration tube. These indications will later be used to calibrate your probe and to build sizing curves.

The units of measurement can be set in percentage or in depth (millimeters or inches).

You can add calibration points by clicking on the *Add* button. Specify the calibration point name, side and size. The side and size of the flaw will be used to position the calibration point in the sizing curve(s).

Calibration points can also be imported with the *Import* button.

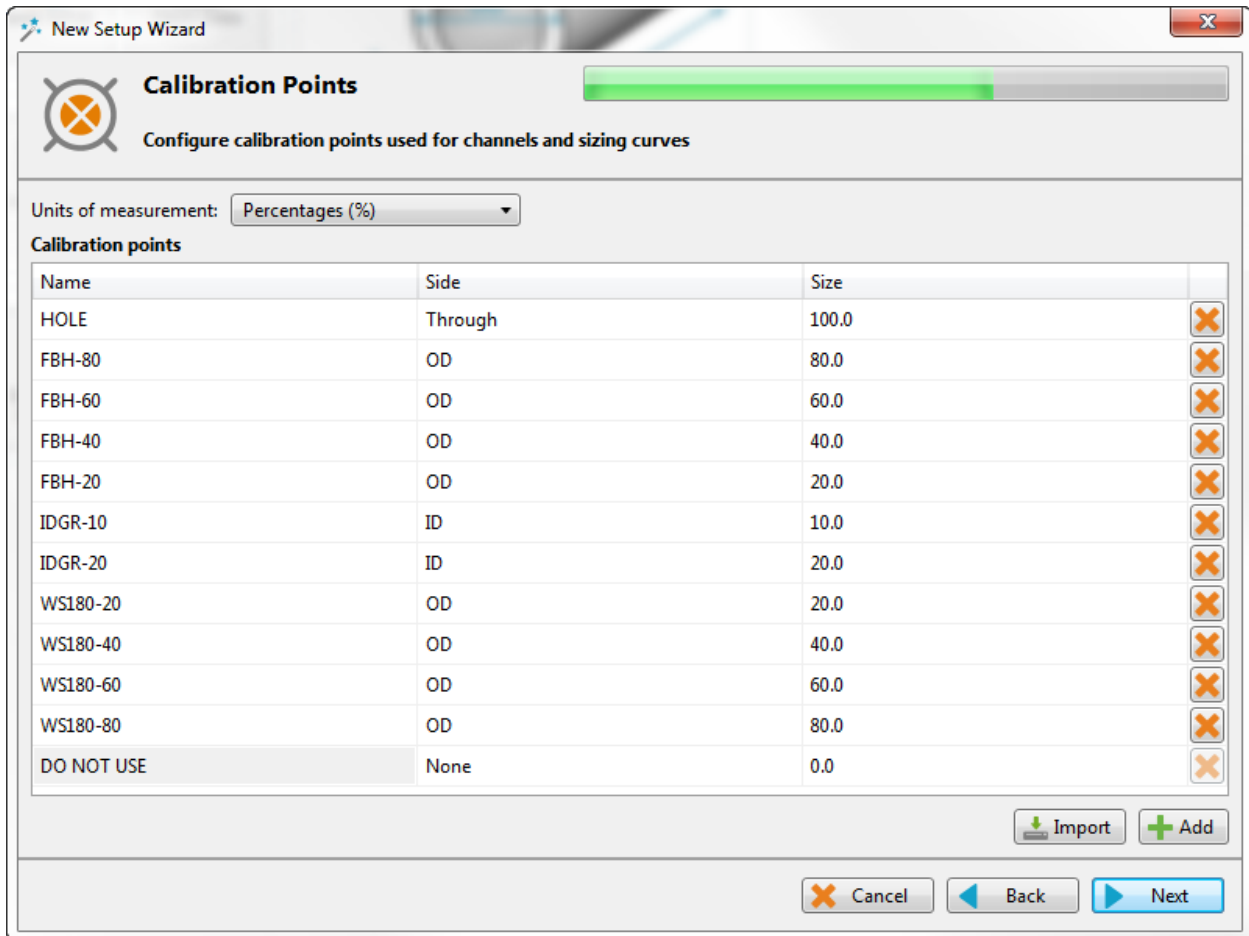

**Calibration Points**  
Configure calibration points used for channels and sizing curves

Units of measurement: Percentages (%)

Name	Side	Size	
HOLE	Through	100.0	X
FBH-80	OD	80.0	X
FBH-60	OD	60.0	X
FBH-40	OD	40.0	X
FBH-20	OD	20.0	X
IDGR-10	ID	10.0	X
IDGR-20	ID	20.0	X
WS180-20	OD	20.0	X
WS180-40	OD	40.0	X
WS180-60	OD	60.0	X
WS180-80	OD	80.0	X
DO NOT USE	None	0.0	X

Import Add

Cancel Back Next

Click *Next* when you have set the required calibration points for your calibration(s) and sizing curve(s).

## CALIBRATION

The *Calibration* pages are used to define reference signal(s) that will be used to set the amplitude(s) and phase(s) of each channel using the selected measurement method.

By default, the calibration is performed on the Hole signal by adjusting it to 1V and 90° on the differential channel. The wear scar 60% is used to calibrate the absolute channel at 6V and 90°. And the inside diameter groove is used to set the trail signal at 10V with a phase of 0°. These calibrations are done to have the amplitude on one axis only (0° or 90°) since signals from the MFL probe don't have a phase. Different reference signals can be set to calibrate the amplitude independently for each channel. Simply modify the parameters in the table to customize the calibration.

Name	Voltage (V)	Amplitude		Angle (°)	Phase	
		Reference	Measurement		Reference	Measurement
ABSDC	6.00	WS180-60	PP	0.0	DO NOT USE	PP
DIF1DC	1.00	HOLE	PP	90.0	DO NOT USE	PP
DIF2DC	1.00	HOLE	PP	90.0	DO NOT USE	PP
DIFDC	1.00	HOLE	PP	90.0	DO NOT USE	PP
TRLDC	10.00	IDGR-10	PP	0.0	DO NOT USE	PP

When you select the reference signal, the system will use the selected measurement method to apply a rotation and a gain. Here is a short description of the available options:

- 1. Absolute (A):**  
Uses a straight line from the Lissajous origin to the main cursor position to measure amplitude.
- 2. Absolute Horizontal (AH):**  
Uses only the horizontal component, from the Lissajous origin to the main cursor position to measure amplitude.

- 3. Absolute Vertical (AV):**  
Uses only the vertical component, from the Lissajous origin to the main cursor position to measure amplitude.
- 4. Absolute Peak (AP):**  
Uses a straight line, from the Lissajous origin to the peak value of the data selection, to measure amplitude.
- 5. Absolute Peak Horizontal (APH):**  
Uses only the horizontal component, from the Lissajous origin to the peak value of the data selection, to measure amplitude.
- 6. Absolute Peak Vertical (APV):**  
Uses only the vertical component, from the Lissajous origin to the peak value of the data selection, to measure amplitude.
- 7. Average Peak (MP):**  
Takes the distances from points at the extremity of the cursor to the peak of the data selection to build an average vector. Only used and recommended for absolute signals.
- 8. Average Peak Horizontal (MPH):**  
Uses the horizontal component of the distances from points at the extremity of the cursor to the peak of the data selection to make an average vector. Used for absolute signals.
- 9. Average Peak Vertical (MPV):**  
Uses the vertical component of the distances from points at the extremity of the cursor to the peak of the data selection to make an average vector. Used for absolute signals.
- 10. Peak to peak (PP):**  
Uses the combination of the vertical and horizontal component to measure the maximum amplitude.
- 11. Horizontal (PPH):**  
Uses only the horizontal component to measure the amplitude.
- 12. Vertical (PPV):**  
Uses only the vertical component to measure the amplitude.
- 13. Peak to peak First Transition (PPF):**  
Uses the combination of the vertical and horizontal components of the first transition of the signal to measure maximum amplitude. The first signal transition is from the base of an indication to its peak.

## SIZING CURVES

The first page of this section is the definition of your sizing curves. A curve will be built for each line in this table.

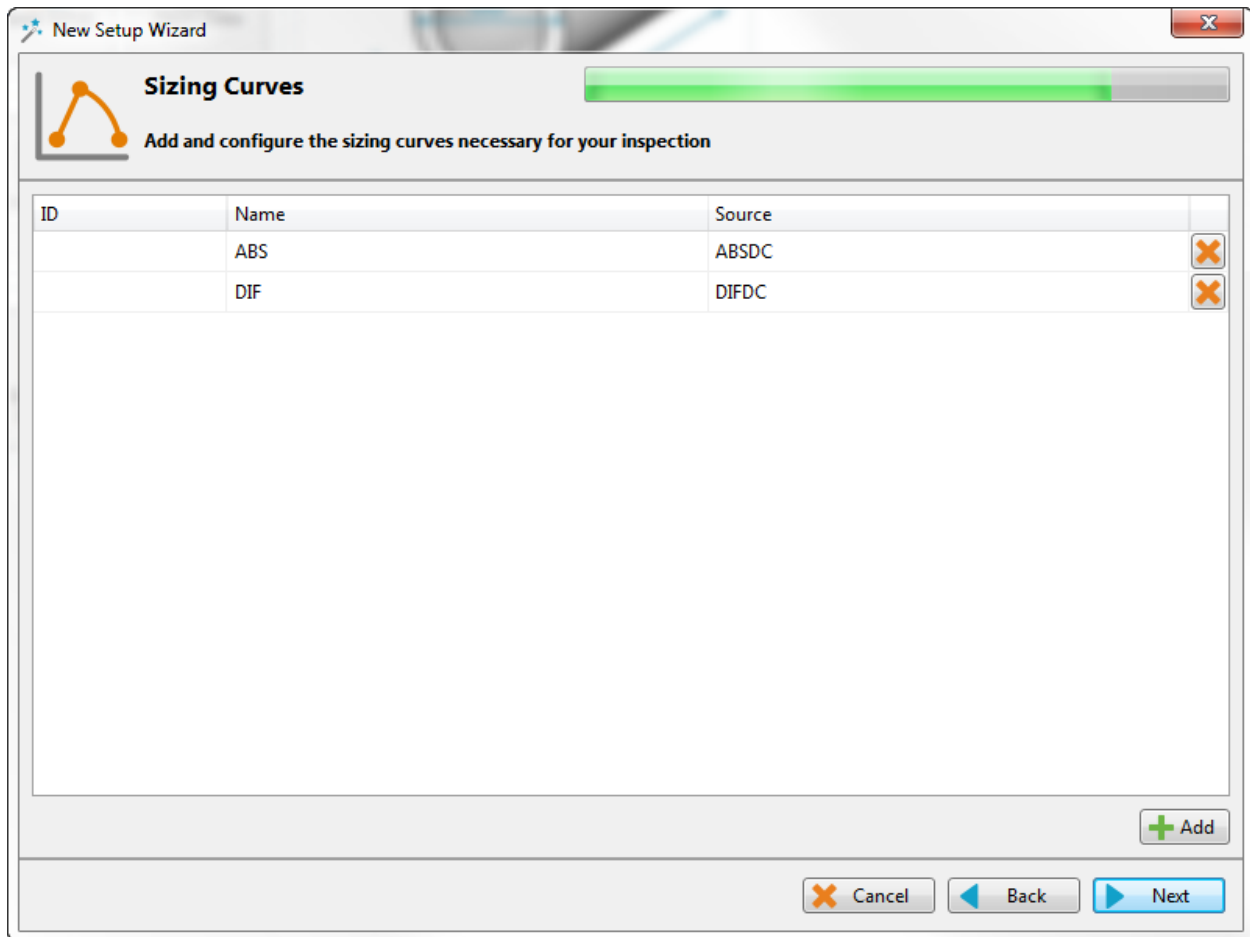

The sizing curve will allow you to estimate the size of a defect based on the calibration points signals obtained with your calibration standard. Magnifi will give you the interpolated flaw size base on the built sizing curves.

Sizing curve names are customizable. The channel source and measurement type can also be changed. You can add sizing curves by clicking on the *Add* button.

Click *Next* when you are done.

For every sizing curve created in the last window, a window will appear to configure the curve properties. The name of the curve will be shown in the upper left corner of the page (ABS in the example below).

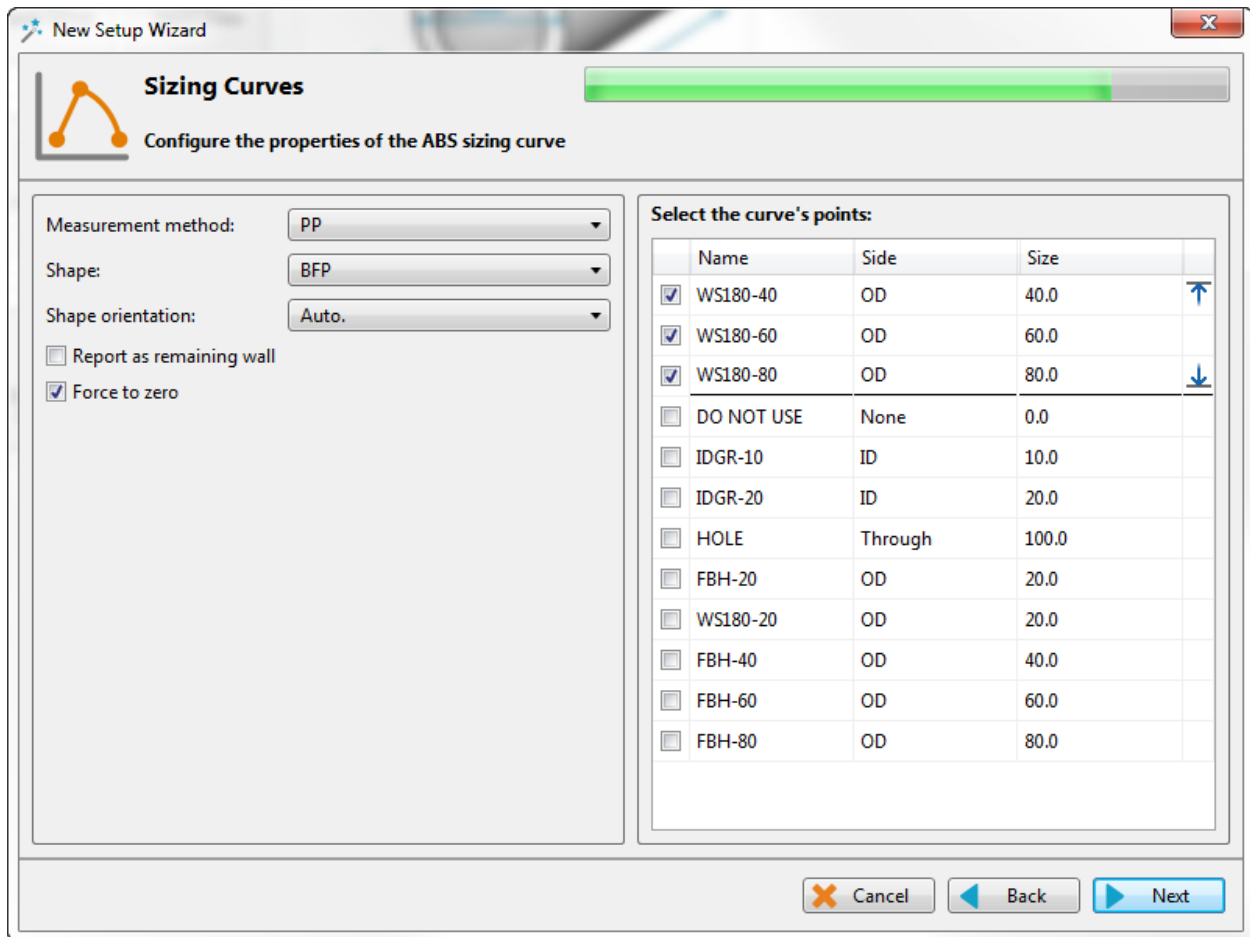

The measurement method options are the same as what is described in the calibration section of this document. By default, the *Peak-to-Peak* option is set for absolute channels and the differential channels.

The interpolation method can be selected with the *Shape* dropdown menu. Here is a short description of the available options:

1. **Best Fit (Dual linear) (for phase measurement only):**  
A curve with two linear segments representing ID and OD (or Near and Far) side calibration points with respect to phase.
2. **Best Fit (Dual Slope) (for phase measurement only):**  
A curve with two segments representing ID and OD (or Near and Far) sides. The ID section is linear, and the OD section is polynomial. The OD side of the curve will need at least three points (including the hole) in order to trace a polynomial curve.
3. **Best Fit (Polynomial) (for phase and amplitude measurements):**  
Best polynomial (degree 2) interpolation within the measured calibration points (requiring at least three points).
4. **Connected Points (for phase and amplitude measurements):**  
Simple, point-to-point curve.
5. **Best Fit (Linear) (for phase and amplitude measurements):**



Best linear interpolation within the measured calibration points

**6. Best Fit (Dual Polynomial) (for phase and amplitude measurements):**

Polynomial (degree 2) interpolation with two segments for both ID and OD side of the curve.

Need at least three points.

Once the measurement method and the interpolation curve shape are chosen, you can select the curve points for each sizing curve previously created. The order in which the points appear in the list may influence your sizing curve. Make sure that the measured values of the calibration points are in ascending order on the list. You can set Magnifi to show the remaining wall instead of the defect size by checking the box *Report as remaining wall thickness*.

Click *Next* when you are done.

## INDICATION CODES

The *Indication Codes* page is used to define the entries that can be added to the report when analyzing the data.

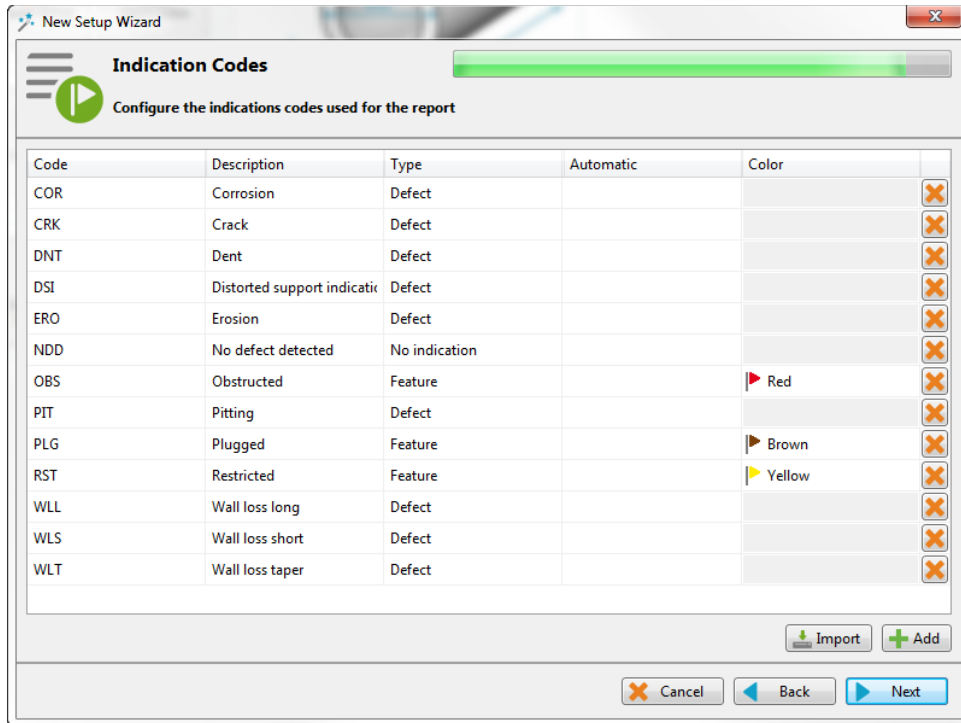

When an indication is added, its abbreviation (code) is shown in the code pane, next to the data.

You can modify the default indications codes list by changing the parameter in the table. New indications can be defined by clicking on the *Add* button.

Click *Next* when you are done

## DISPLAY

The first *Display* window is used to set how the data is displayed during and after the acquisition.

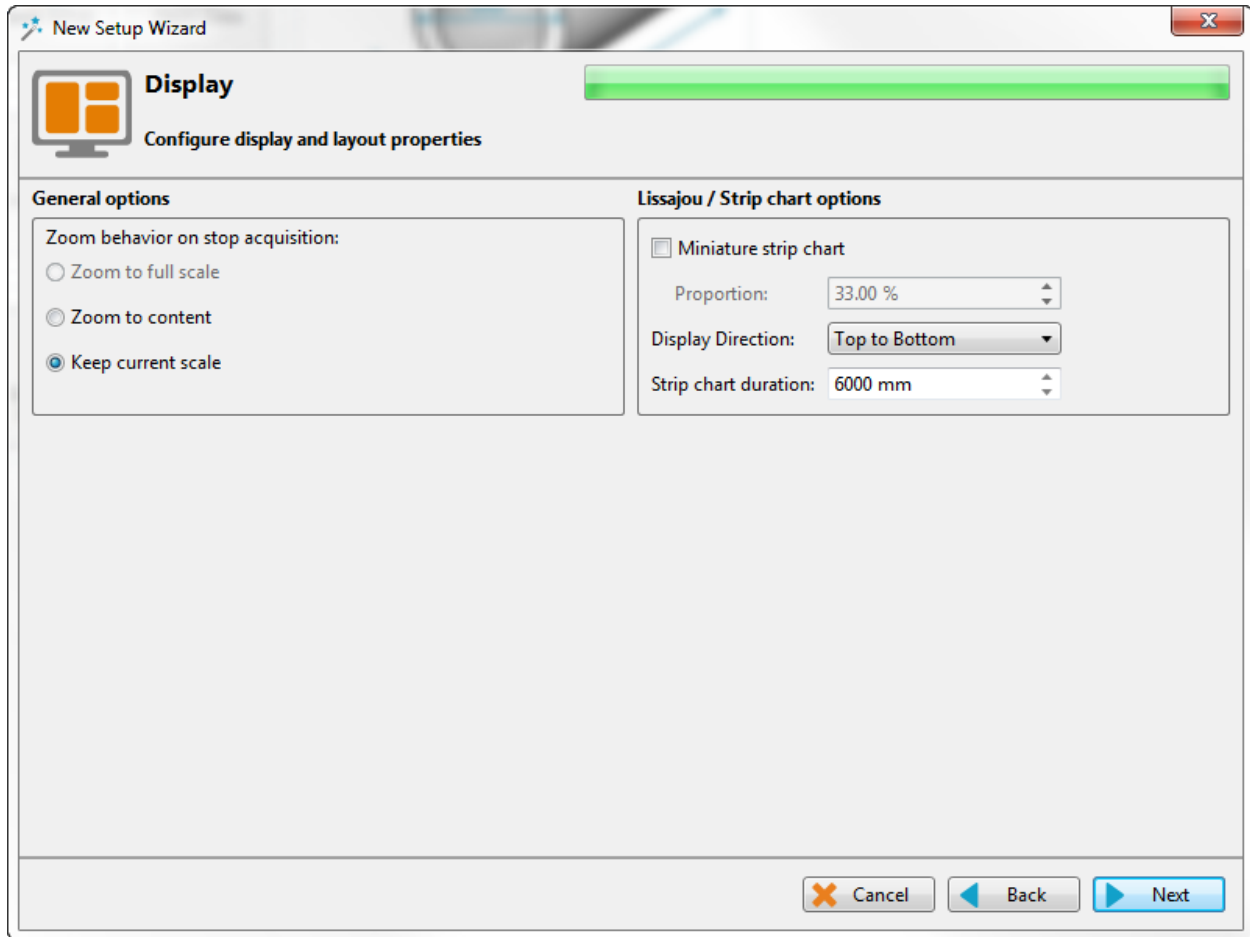

The scroll direction is the direction in which data appears on the screen. If you choose downward, the signals will go from the top to the bottom of the screen. If you choose the upward direction, the signal will go from the bottom to the top of the screen.

You can enable/disable the miniature strip chart under the Lissajous by checking/unchecking the box.

The strip chart duration is the length of a Strip chart window when the data is acquired.

Click *Next*.

The second *Display* window is used to set the layouts. Check marking the proposed layouts will make them available in your setup. You will be able to switch from one to the another via the layout tab. The " S " stands for Strip chart, " L " for Lissajous and " C " is for the defect Code indication zone.

The layout with the blue background will be the one opened by default, which can be changed to your desired option.

Layouts can be readjusted at any time.

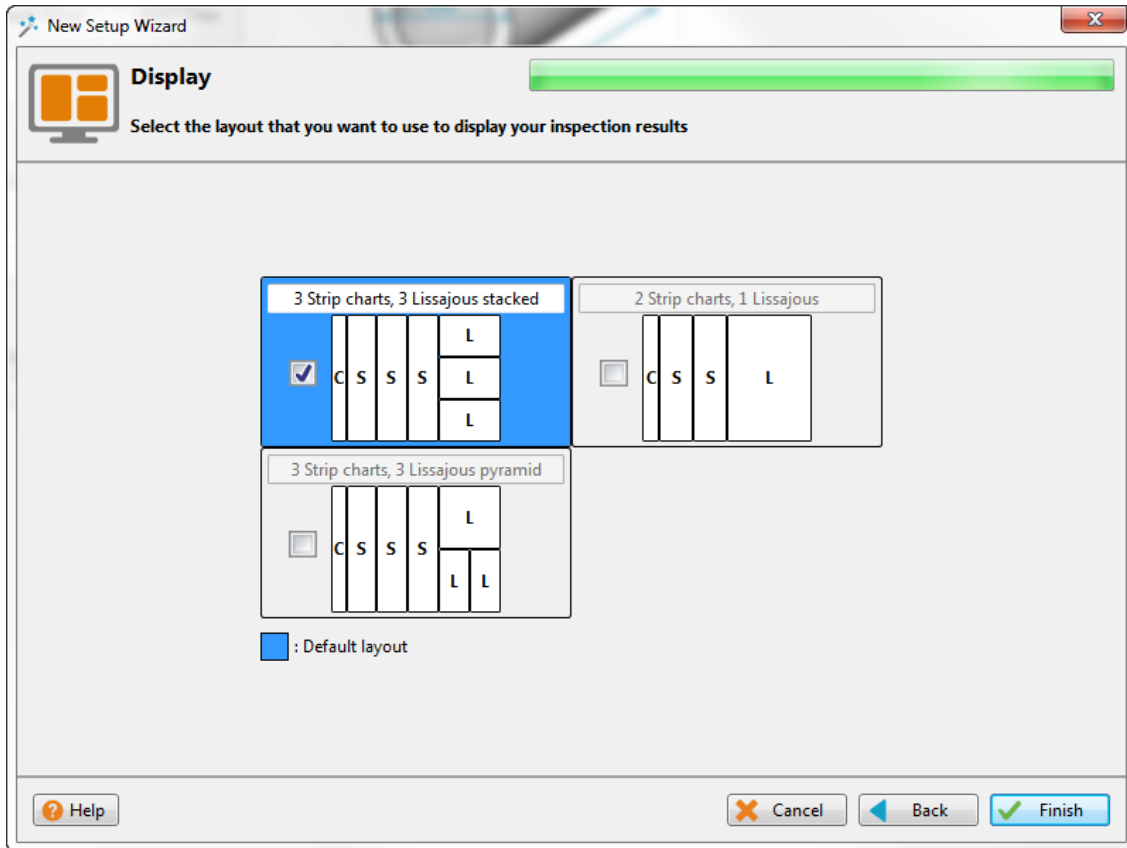

Click *Next* to complete the setup wizard process.

## SETUP MODIFICATIONS

Some parameters or preferences may need to be modified after the *Setup Wizard* process. To modify the parameter previously entered, you can go to the *Setup* tab in the *Frontstage* and click on the button associated with the parameter you want to change.

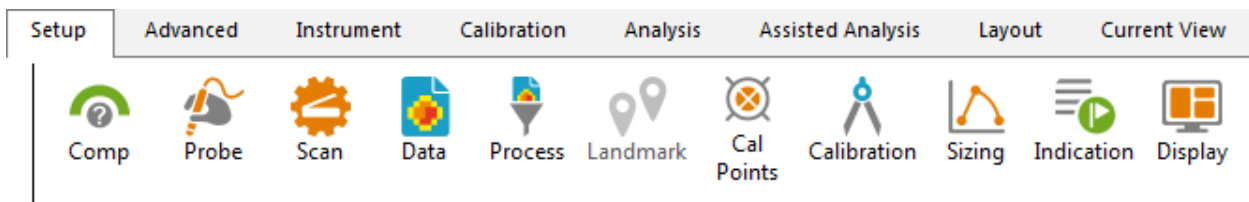

This will open one of the windows previously described, where you can change the values you originally entered. If applicable, go through the process by clicking on *Next*, and then click on the *Finish* button. This will apply the modification to the setup.

Advanced settings can be found under the *Advanced* tab of the *Frontstage*. If parameters are changed using the advanced settings, the information shown using the *Setup* tab may not match your actual setup.

## SMART SETUP TOOLS

Additional functions, which facilitate data analysis, can be set up under the SMART Setup tab.

### LOGBOOK

The first button on the left side under the SMART Setup tab allows you to enable or disable the logbook.

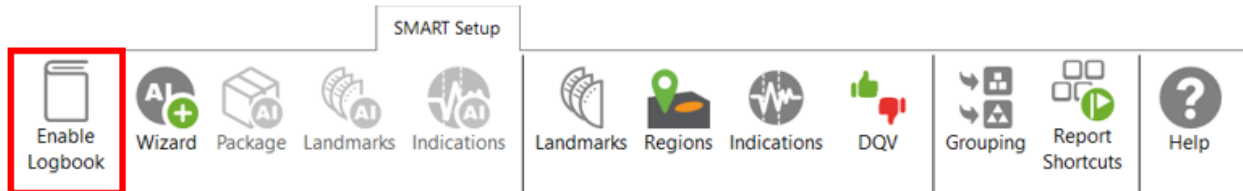





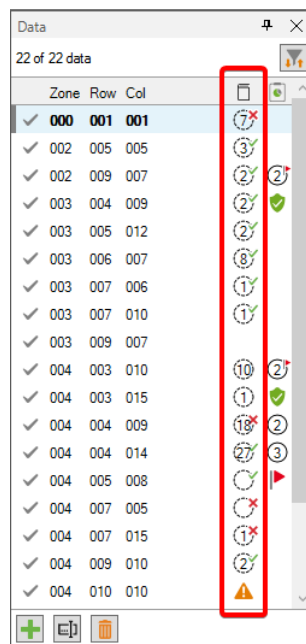

The logbook stores information about the analysis in addition to allowing the following functions: batch screening, seeing results at a glance from the data list pane and saving manual modifications made to the landmarks during the analysis.

The logbook stores the following information: landmarks (type, position, dimension, including manual modifications), indications (AI and conventional, label, position, dimension, etc.), indication grouping, and data quality validation results. When enabled, an additional column is added to the data file list to allow seeing results and to filter, sort, or analyze according to these results.



The following table shows the possible icons and their meaning:

Icon	Description	Meaning
(empty)	Empty	No logbook entry associated with this file because it has not been screened yet.

	Dashed outline circle, without a number	Logbook entry associated with the file contains information such as landmark detection or regions. The absence of additional information on the icon reveals that no indication detection engine or DQV tests were enabled when the logbook was written.
	Dashed outline circle, with a number	Logbook entries associated with the file contains information such as landmark detection as well as detected indications. The number displayed inside the circle shows the quantity of potential indications detected. No DQV tests were enabled when the logbook was written.
	Dashed outline circle, with a green check mark	The green check mark indicates that the DQV test(s) passed on this file.
	Dashed outline circle, with a red cross	The red cross indicates that at least one DQV test(s) failed on this file.
	Dashed outline circle, with a number, with a green check mark	The logbook entries associated with this file indicates that potential indications have been detected by the detection engine and that the DQV test(s) passed.
	Dashed outline circle, with a number, with a red cross	The logbook entries associated with this file suggest that potential indications have been detected by the detection engine and that at least one DQV test(s) failed.
	Orange warning triangle	The AI detection tools identified an unusual situation. In this case, the level of confidence in the detection findings could be very low. Therefore, users should pay special attention when reviewing the detection results.

The logbook is saved within the inspection folder. Its data is written when a file is screened using the dedicated buttons in the Analysis ribbon. It is also automatically written when a file is loaded while the logbook is enabled, and no logbook entry existed for this file yet.

It is worth mentioning that the logbook also includes defects and landmarks, even if these have been detected with detection tools that do not use AI (conventional landmark detection and indication boxes). Also note that the automatic indication detection tools are not available if you use the acquisition license (ACQ).

# LANDMARKS

The Landmarks button is used to setup the parameters for landmark detection with conventional tools.

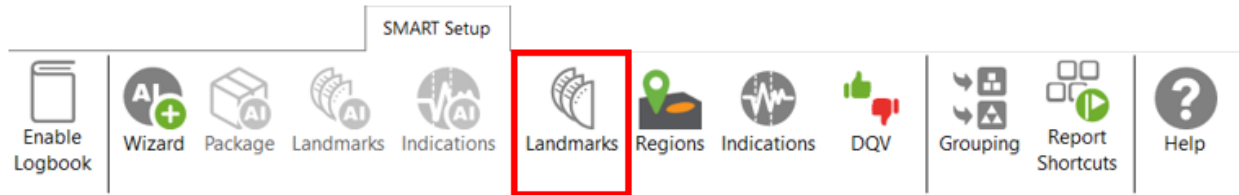

The Landmark Detection window is used to configure the automatic detection of features such as tube sheets and support plates. Landmarks are not mandatory and don't need to be set to have functional setup. They can however give a reference for the axial position in a tube. They can also be used by the software to trigger automatic acquisition sequences.

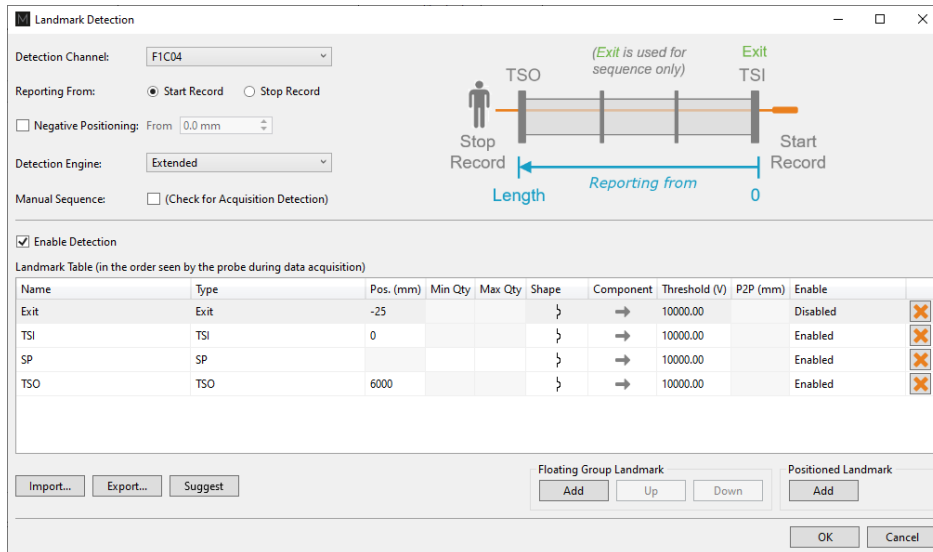

Three landmarks are created if you press on the Suggest button. The channel selected to detect these landmarks should be the lowest frequency absolute channel. The R\_ before the channel stands for Raw. This is the signal of the channel without software filter, rotation, or software gain applied.

You can base the position of your landmarks either on the location where you start to record (usually the tube entrance, opposite from the operator position) or on the place you stop to record (usually the operator side).

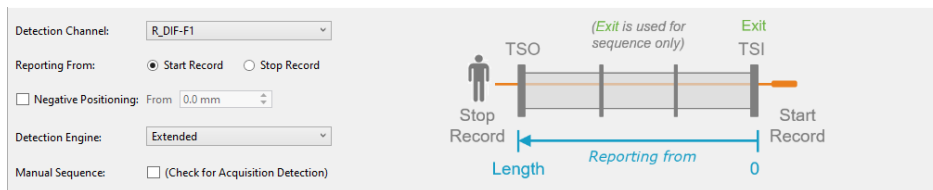



In the above example, the Exit landmark is detected when the probe exits the tube at its outer end. It has a negative position because this event happens before entering the tube. It is enabled only when doing the acquisition.

TSI is the first tube sheet encountered when the probe is pulled. TSO is the last tube sheet encountered at the end of the acquisition.

Landmark detection can be set up manually by describing the shape, component, and voltage threshold that will trigger the detection. The Shape describes the appearance of the signal when the landmark is reached. If a differential signal shape is chosen, the Peak-to-Peak distance (“P2P”) will also be needed. The Direction is the projection axis (horizontal or vertical) of the Lissajous signal that will be taken to trigger the landmark. And the Threshold is the voltage amplitude threshold.

Landmarks can be calibrated on real signals; in this case, there is no need to change these parameters as they will be automatically measured by the software. It’s important to set the landmark positions as accurately as possible. If the position is not accurately set, the software might prevent their automatic detection since it won’t be at an expected position.

The Type field is a name that associates the calibration point with the landmark. If landmarks share the same Type, they will be calibrated at the same time using the same point and process. To associate two landmarks with the same Type, their signal must be the same. If support plates of the same geometry are present in a bundle, they can share the same Type. In the above example, TS1 and TS2 don’t share the same Type because one is triggered when the probe goes inside the tube and the other is triggered when the probe exits the tube.

The Detection Engine drop-down menu can be set to Legacy or Extended. With the Legacy mode, all the landmarks need to be entered with the right position. The system will look for the exact number of landmarks entered at positions close to those entered in the table. With the Extended mode, the system will look for a number of landmarks between the Qty max and the Qty min. With this mode, the exact number of support plates don’t need to be constant or known.

## REGIONS

The Regions option allows the user to define inclusion/exclusion zones based on Landmarks. This is used to categorize the data to process correctly. For example, they can be useful for restricting the detection of channel saturation to an area within the tube or specify an automatic analysis type for a given region (e.g., under the tubesheets).

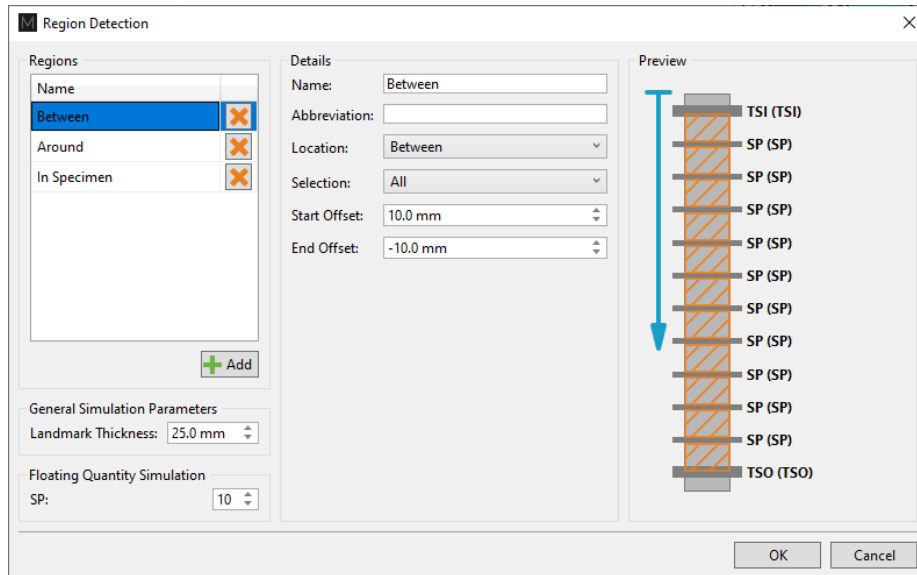
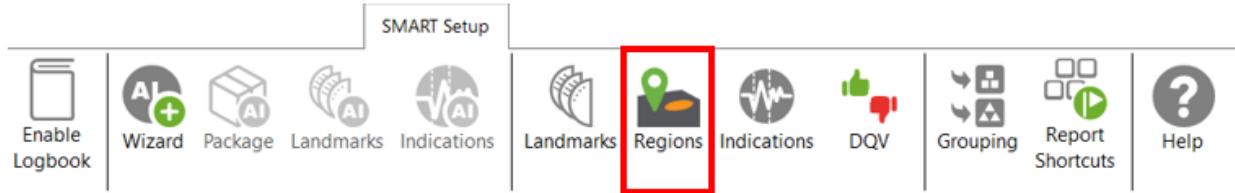

If you are using the conventional detection tools, you can set up the regions according to the automatic analysis tools you will use with the Indications and DVQ buttons (described later).

## INDICATIONS

The Indications module allows the user to define various zones or even waveform types to trigger a certain detection threshold.



These detection zones can be applied to conventional channels and C-scan channels. The Label is the name that will appear in the Code view.



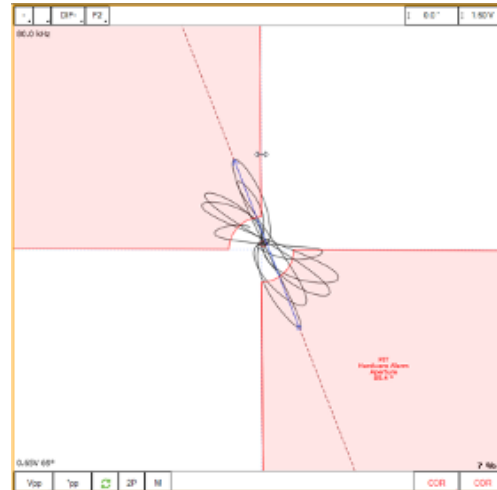
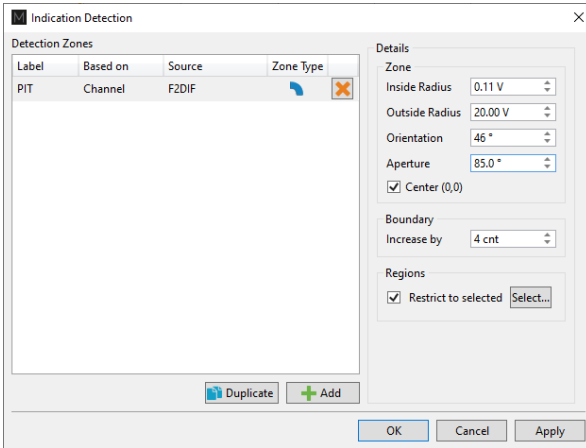

There are five zone types:

	Absolute pie
	Differential pie
	Centered rectangle
	Rectangle
	Over or under a horizontal or vertical threshold

And seven waveform types:

	Up
	Down
	Down-up
	Any direction
	Up-down
	Down-up-up
	Up-down-up-down

Each zone or waveform can be linked to a defined region, and thresholds can be set. The zone types also include the boundary setting to prevent signal oscillation from triggering unnecessary detections.

Detection zone parameters can also be set by clicking on the Lissajous of the used channel and activating the Edit Alarm option on the Current View tab.

The detected indication can be found in the Indication window, which can be activated in the Layout tab.

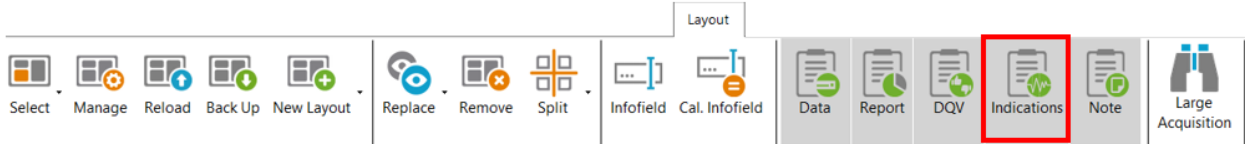

Clicking on an indication in the pane instantly positions the cursor on the selected indication in the Strip chart view. If you click on an indication in the code view (described later), the associated indication is highlighted in the Indications pane.

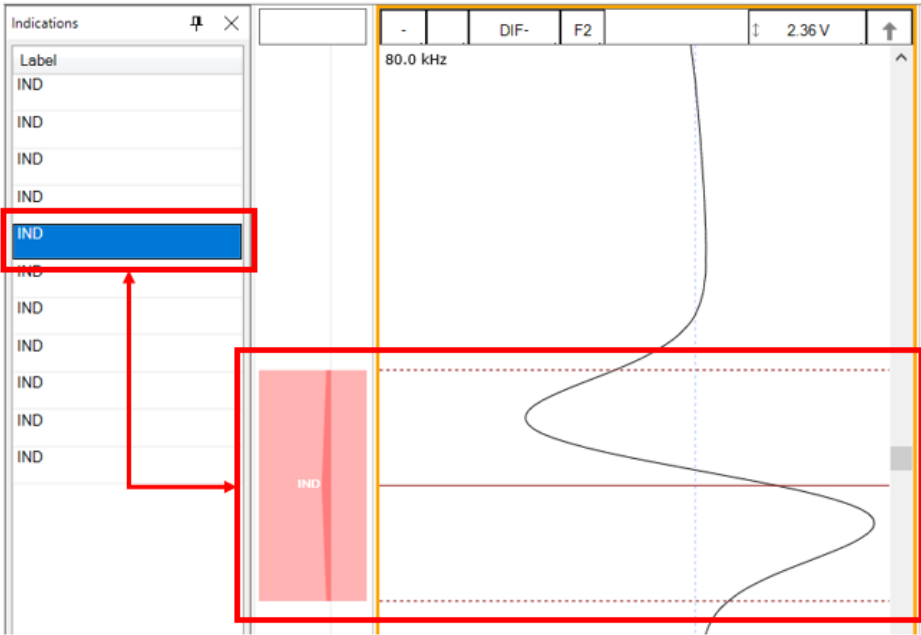

### DATA QUALITY VALIDATION (DQV)

Data Quality Validation allows defining tests to validate the quality of the data.

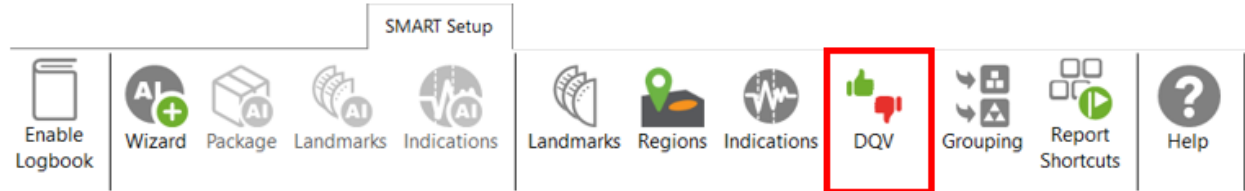

Five test types are available. To add a test, click on the Add button on the DQV page and select the test type with the drop-down menu. Parameters associated with this test can be changed in the Details section of the DQV window.

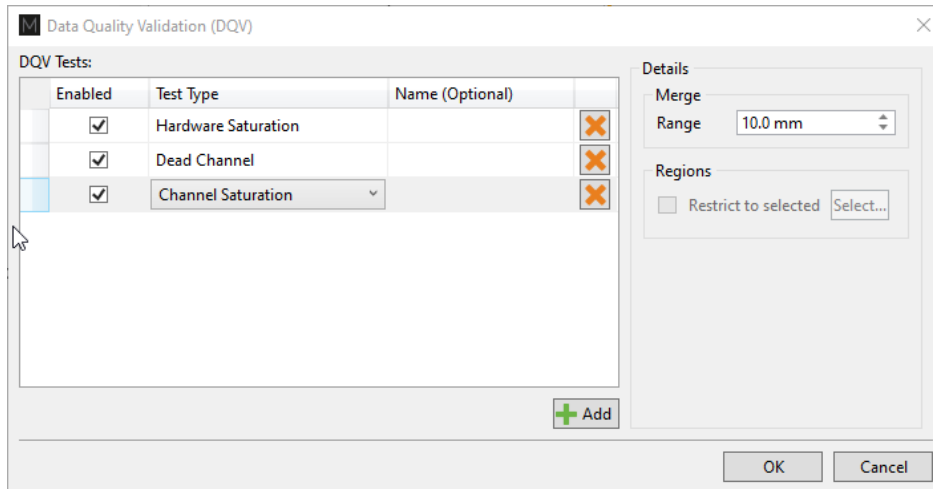

- **Dead Channel:** Verify that channels are reading a signal whose amplitude is above a defined threshold. An amplitude that remains below the threshold throughout the scan indicates a dead channel.
- **Landmark Detected:** Verify the presence of all the selected landmark names in the Details section. To validate full tube-length of straight bundles for ECT bobbin data using AI detection, select this option and check the TSI and TSO landmarks. When AI setup for landmarks is completed and the TWH calibrated, the DQV test will automatically use the AI results to perform the test.
- **Hardware Saturation:** Verify if signal saturation appears on raw channels. The merge field allows grouping a zone together for which the test has failed. This function avoids having many notifications if the test fails several times in one area. This test can be limited to a specific region, for example, the areas inside the tube.
- **Channel Saturation:** Verify if signal saturation appears on calibrated channels. The merge field allows group a zone together for which the test has failed. This function avoids having many notifications if the test fails several times in one area. This test can be limited to a specific region.
- **C-scan Saturation:** Verify if signal saturation appears on C-scans. The merge field allows grouping a zone together for which the test has failed. This function avoids having many notifications if the test fails several times in one area. This test can be limited to a specific region.

The results of the DQV tests can be found in the DQV window, which can be activated in the Layout tab.

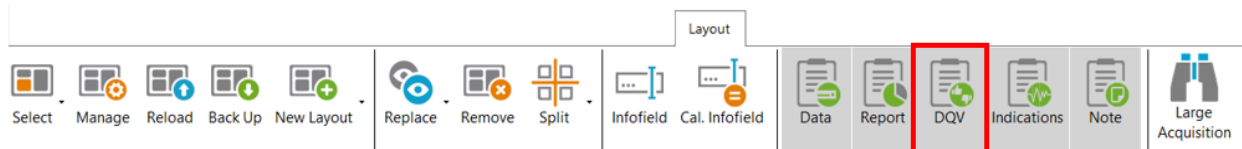

The screenshot shows a window titled 'DQV' with a table of test results and a section for failures.

Test	Result
Channel Saturation	✘ 8 errors
Hardware Saturation	✘ 2 errors

Below the table is a 'Failures' section with a table of criteria:

Criteria	
Hardware Saturation	!
Hardware Saturation	!

At the bottom of the window, there are tabs for 'Indications' and 'Note'.

## GROUPING

The grouping tool can help the analyst find critical indications for review as it categorizes and groups the automatically detected indications.

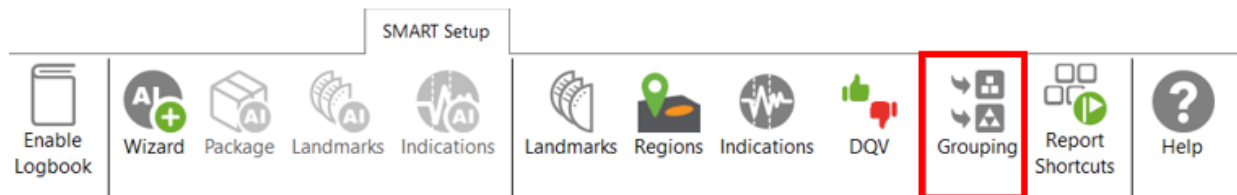

The Grouping menu offers a default configuration with three predefined categories:

- Support Plates
- Critical
- Less Critical

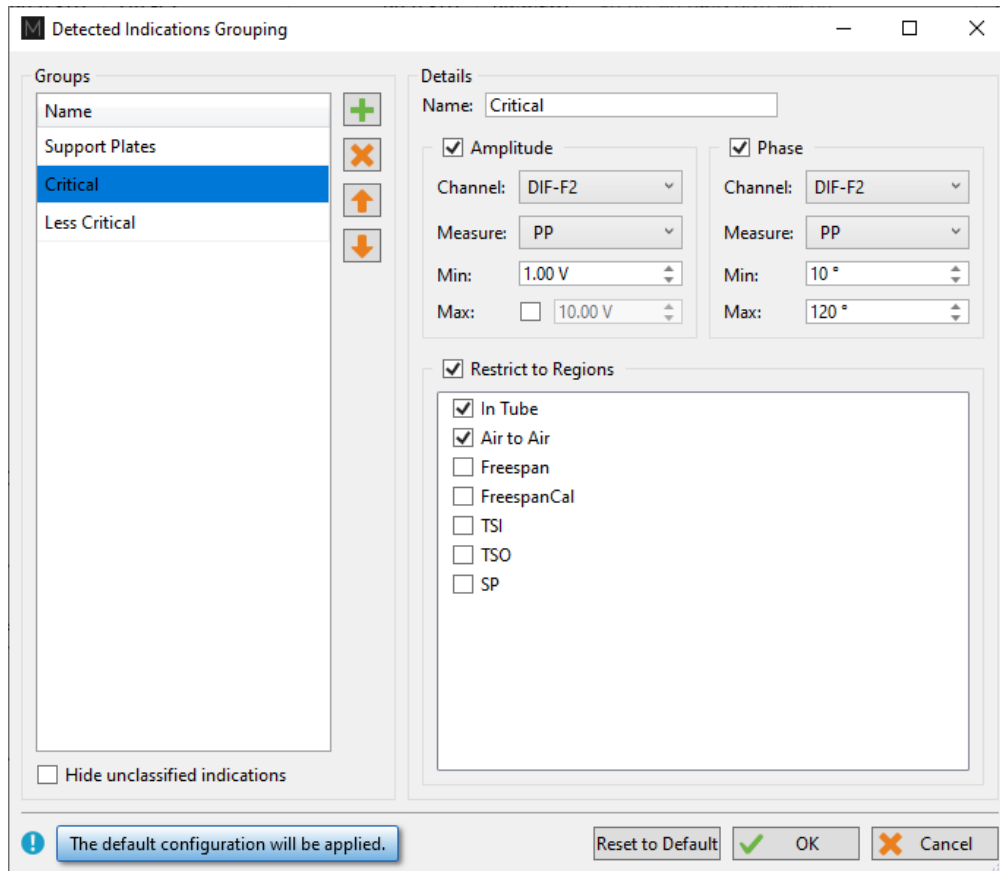

The Details section of each group shows the parameters defining the conditions that must be met for a detected indication to be classified in this group. The user can modify all parameters.

By default, the Support Plates group is configured with the mix channel with a Peak-to-Peak (PP) measurement method, and Max/Min threshold values are set for amplitude and phase. For this group, the criteria are limited to indications detected under the SP regions. As a result, the indications detected under support plates for which all conditions are true will fall into this category.

Critical and Less Critical are two other groups predefined in the Grouping window. Both groups are set on DIF-F2 channel, but with different Amplitude/Phase measurement settings. In both cases, the grouping criteria is restricted to In Tube and Air to Air (for calibration tubes) regions, which covers the full-tube length data.

It should be noted that each automatically detected indication can only be categorized in a single group. Also, the grouping operation is executed according to the order of the groups defined in the Groups list. Therefore, if a given indication meets all the criteria of the first group, it will be categorized in this group. If not, it will be passed to the following group. If it meets all the criteria of the second group, it will be categorized into this one. If not, it will again be passed to the next group, and so on. If an indication does not meet the criteria of any group, it will be placed in the Unclassified group. This implies that every single indication will be categorized, and none can appear simultaneously in more than one group.

New groups can be created with custom parameters.

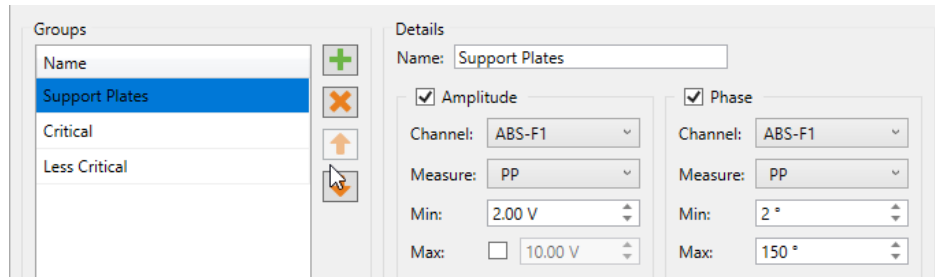

It is also possible to remove a group or use the up/down arrow keys to change the group priority within the list.

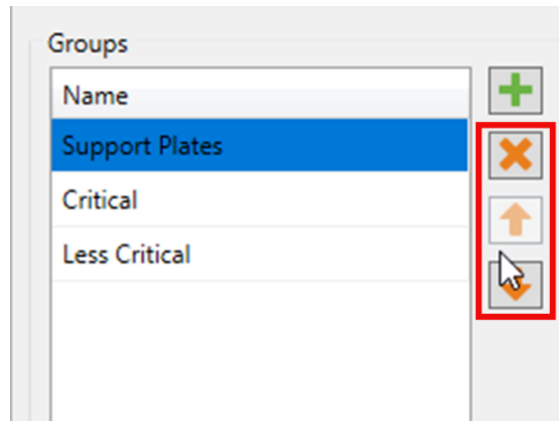

In the Front stage interface, the Grouping results will be displayed in the Indications pane.

Indications 10 of 10 results

Label	Ampl.	Phase
<b>^ Critical (4)</b>		
IND	14.15 V	82 °
IND	3.40 V	83 °
IND	2.78 V	106 °
IND	7.06 V	16 °
<b>^ Less Critical (4)</b>		
IND	1.02 V	111 °
IND	1.00 V	40 °
IND	1.27 V	56 °
IND	1.13 V	73 °
<b>^ Unclassified (2)</b>		
IND		
IND		

DQV Indications Note

To help the analyst focus on the most relevant detected indications furthermore, it is possible to hide the Unclassified indications. To accomplish this, check the box “Hide unclassified indications” at the bottom of the Grouping menu and click on OK.

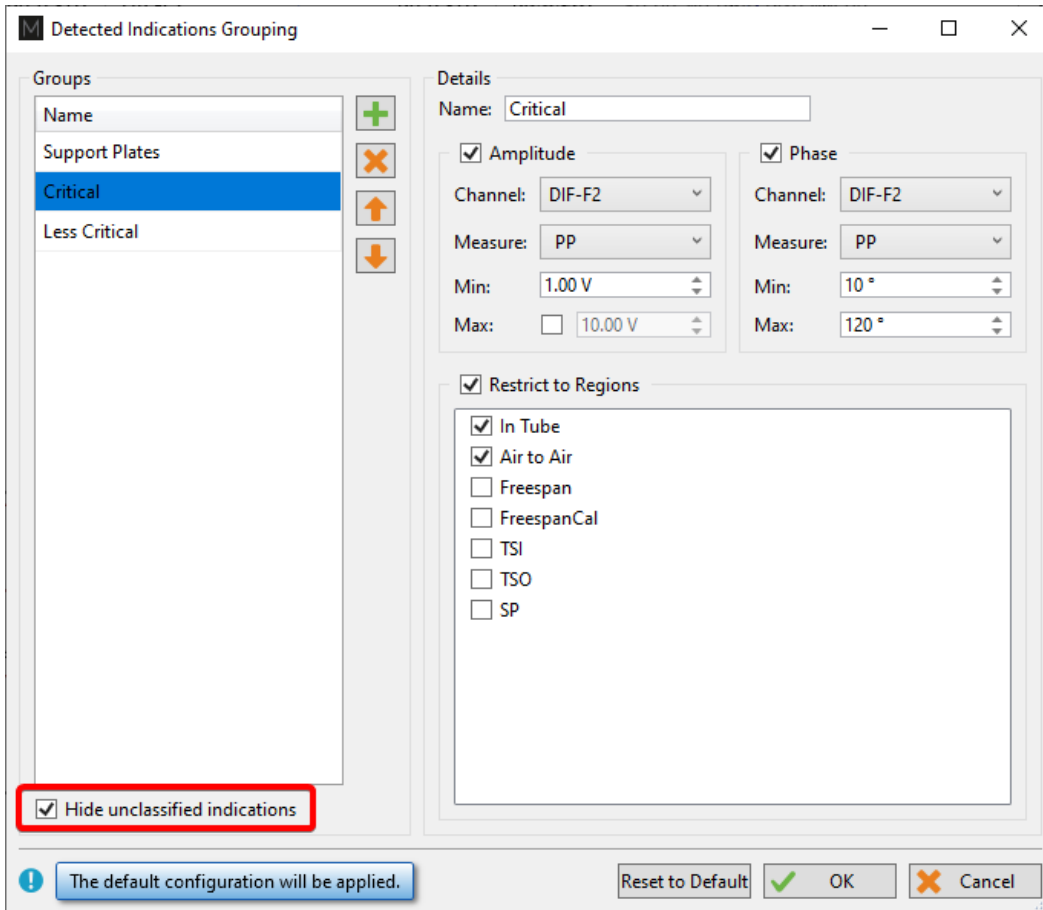

Enabling this option influences the following elements of the software:

- Indications pane;
- Code view;
- Logbook column.

The images below compare them when the Unclassified indications are shown (left) and when they are hidden (right).

When the option is enabled, the Indications pane will not show the “Unclassified” group. The count in the header serves as a reminder to the user that not all indications are currently shown.

Indications 26 of 26 results

Label	Ampl.	Phase
<b>^ Critical (1)</b>		
IND	1.53 V	17 °
<b>^ Less Critical (5)</b>		
IND	1.00 V	14 °
IND	0.93 V	10 °
IND	0.84 V	18 °
IND	0.76 V	17 °
IND	1.20 V	19 °
<b>^ Unclassified (20)</b>		
IND		
IND		
IND		
IND		
IND		

DQV **Indications** Note

Indications 6 of 26 results

Label	Ampl.	Phase
<b>^ Critical (1)</b>		
IND	1.53 V	17 °
<b>^ Less Critical (5)</b>		
IND	1.00 V	14 °
IND	0.93 V	10 °
IND	0.84 V	18 °
IND	0.76 V	17 °
IND	1.20 V	19 °

DQV **Indications** Note

In the Code view, the red markers from the Unclassified indications have been removed.



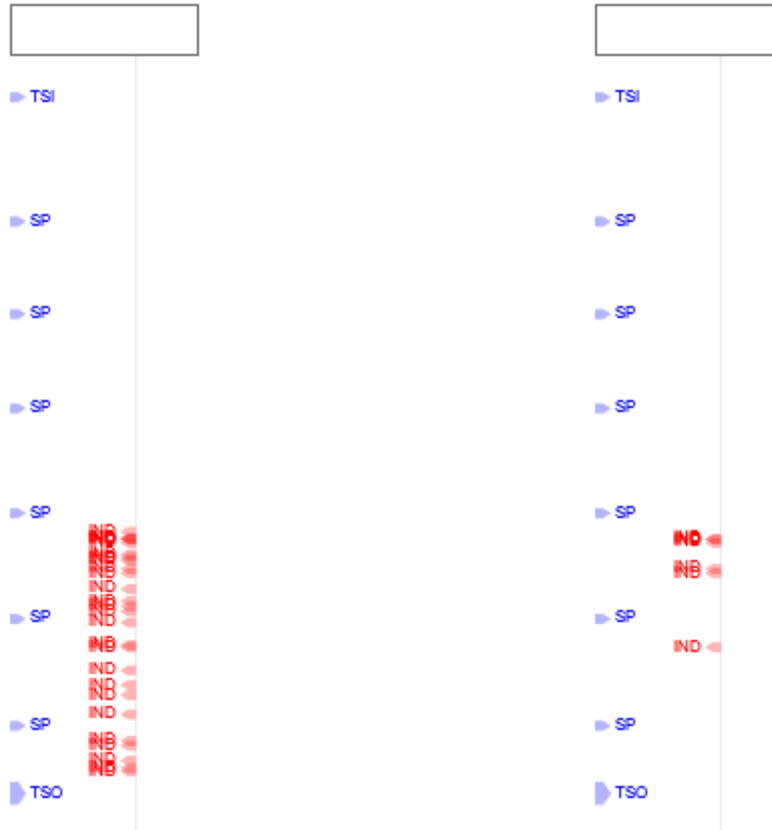

In the data file list, the number shown in the Logbook column represents the number of visible indications, matching the number shown in the header of the Indications pane.

Data		↑	×
7 of 7 data		⏏	
Row	Col		
✓	201000001		
✓	201004005		
✓	<b>201006009</b>	(26)	
✓	201006016		
✓	201024022		
✓	201025017		
✓	201025019		

Data		↑	×
7 of 7 data		⏏	
Row	Col		
✓	201000001		
✓	201004005		
✓	<b>201006009</b>	(6)	
✓	201006016		
✓	201024022		
✓	201025017		
✓	201025019		

## REPORT SHORTCUT

Keyboard shortcuts can be used to make entries in the report. By opening the shortcut window, it is possible to select a channel with a measurement method and to associate an indication with it.

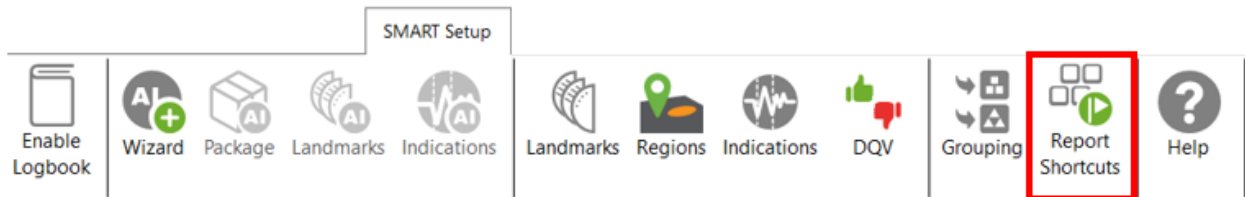

For example, we could use the differential channel F2 with a Peak-to-Peak measurement method to enter pits in the report.

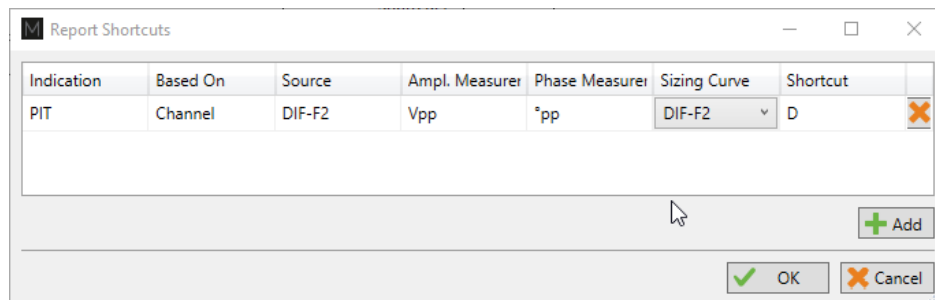

To select a key, press the Shortcut field and press the desired key on your keyboard. It is possible to use a single key or a combination of keys such as ALT+D, for example.

When a report entry is made with the keyboard shortcut, the abbreviation of the type of indication displays momentarily on the corresponding Lissajous.

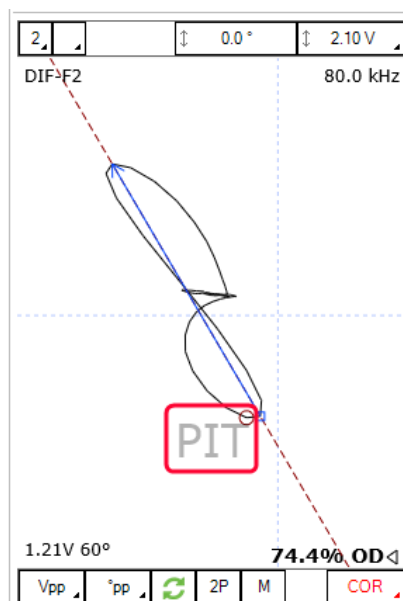

## DATA SCREENING

Data screening set up with the SMART Setup tools can be performed by the two buttons on the left under the Analysis tab.



It is possible to run analysis on a selection of files or all files. The analysis is typically performed on all files when the setup and calibration are adequate. The results are recorded in the logbook and can be viewed in the Data window.

## DATA LIST

Magnifi will save a file for each inspected tube. The file names are defined by creating a list of tubes.

This list can be created in the *Data List* section of the *General* tab of the *Backstage*.

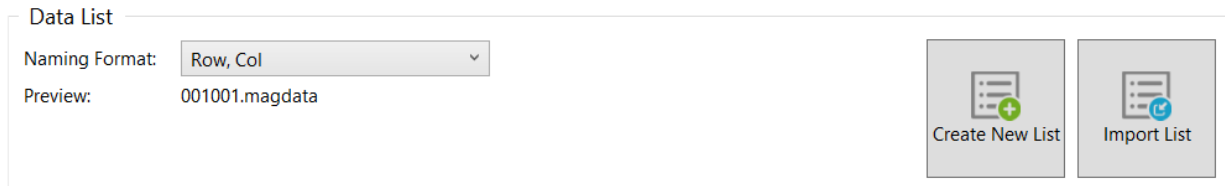

- 1. Free format:**  
Each file has a custom name. Can also be defined from the Data tab of the Front Stage.
- 2. Prefix:**  
The file name includes a defined prefix followed by a sequential number.
- 3. Row, Col:**  
Row number, Column number. Mostly used for tubing inspections.
- 4. Zone, Row, Col:**  
Zone number, Row number, Column number. Mostly used for tubing inspections.

Click on the *Create New List* button. The displayed window will be different depending on the chosen filename format.

For the *Row, Col* option, enter the number of rows, the starting row number and row interval. You can then enter the number of tubes per row in the *Nb. of Columns* fields of the table. Click on *Create* to

generate the list of tubes. You can also use the *Create & New* button to add another set of tubes to your list.

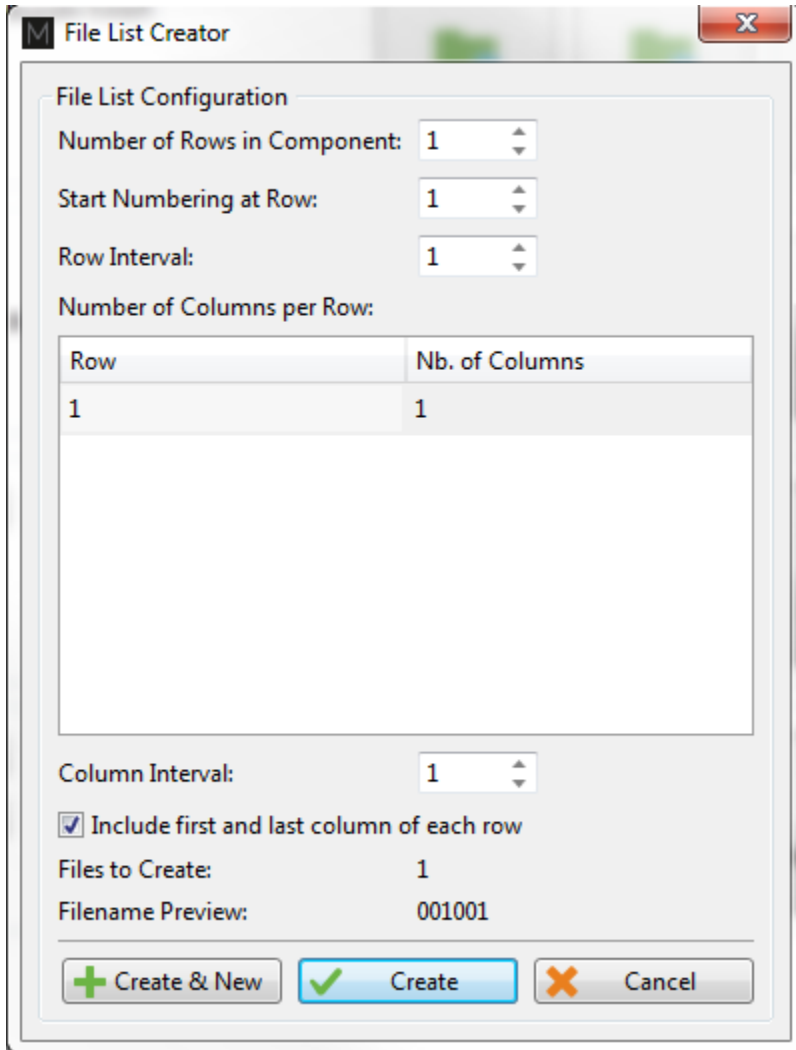

The same principles apply to the other file formats, except for the *Free format* option for which the file name(s) needs to be entered manually in the *Data* window of the *Frontstage*.

The tube list can also be imported from another project using the *Import List* button. The tube list file can be found in the *Inspection* folder. It is also possible to import a list created in the *TubePro* software (available from Eddyfi).

## PERFORMING AN ACQUISITION

1. If you are in the *Backstage*, move to the *Frontstage* by clicking on *Start/Resume* button.
2. Click on the *Connect* button under the *Instrument* tab. This will open the *Instrument configuration* page. Click on the line showing the instrument to which you want to connect and then click *Connect*.

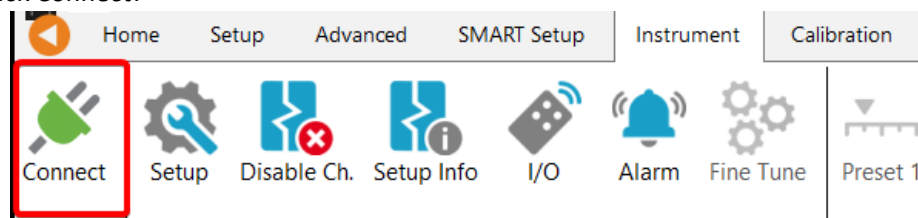

Note: Your Ectane firmware version may not match the version of Magnifi you are using. If this is the case, a red and white X icon will be shown in the *Status* field of the *Instrument connection* window. To download a matching version to your Ectane, click on the *Config.* button and then click the *Send firmware to the instrument* button of the *Instrument configuration* window.

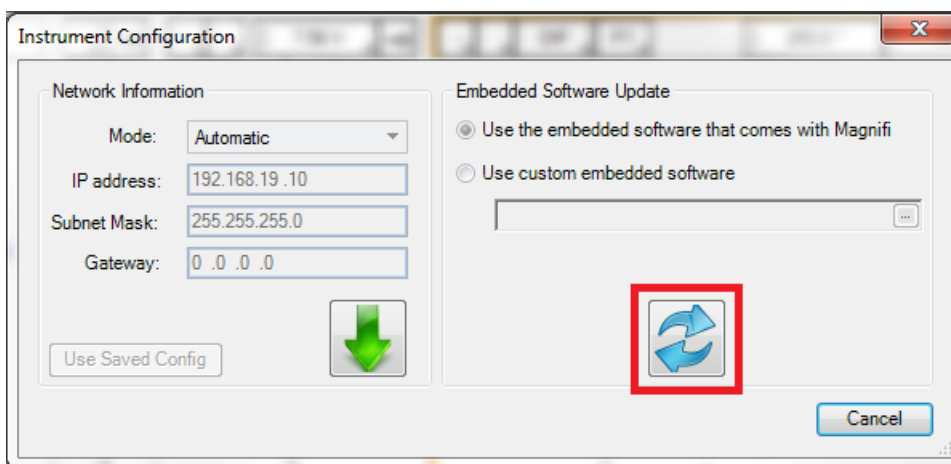
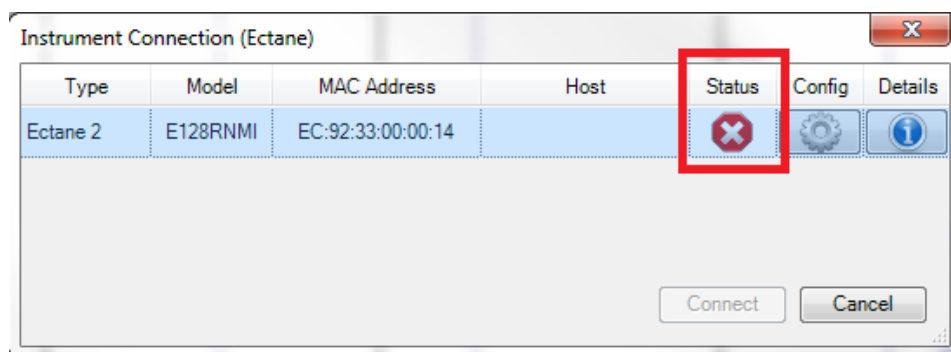

Two acquisition modes are available in Magnifi: *Setup Mode* and *Acquisition Mode*. The *Setup Mode* is used to scan your calibration tube and make the necessary adjustments on your setup without saving the data automatically. Acquisition mode is used for the inspection. In this mode, the software automatically saves the acquired data using file names based on the tube list.

- For the calibration phase, go to *Setup Mode* by clicking on the *Setup Mode* button under the *Home* tab. This mode is active when the *Setup Mode* button is grayed.

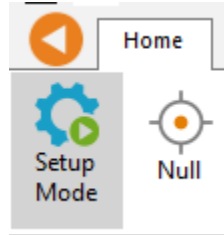

- Plug the MFL probe on the Ectane 19-pin connector.
- Bring the probe head in a clear area in your standard and balance the probe by clicking on the *Null* button under the *Home* tab, or press F6 on your keyboard.
- Push the probe head all the way through the tube so that it exits the tube.
- Start the acquisition by clicking on the *Acquire* button under the *Home* tab or by pressing the F2 on your keyboard.
- Pull the probe at approximately 1 m/s.
- When it's done, press the *Stop* button or F2 again on your keyboard.

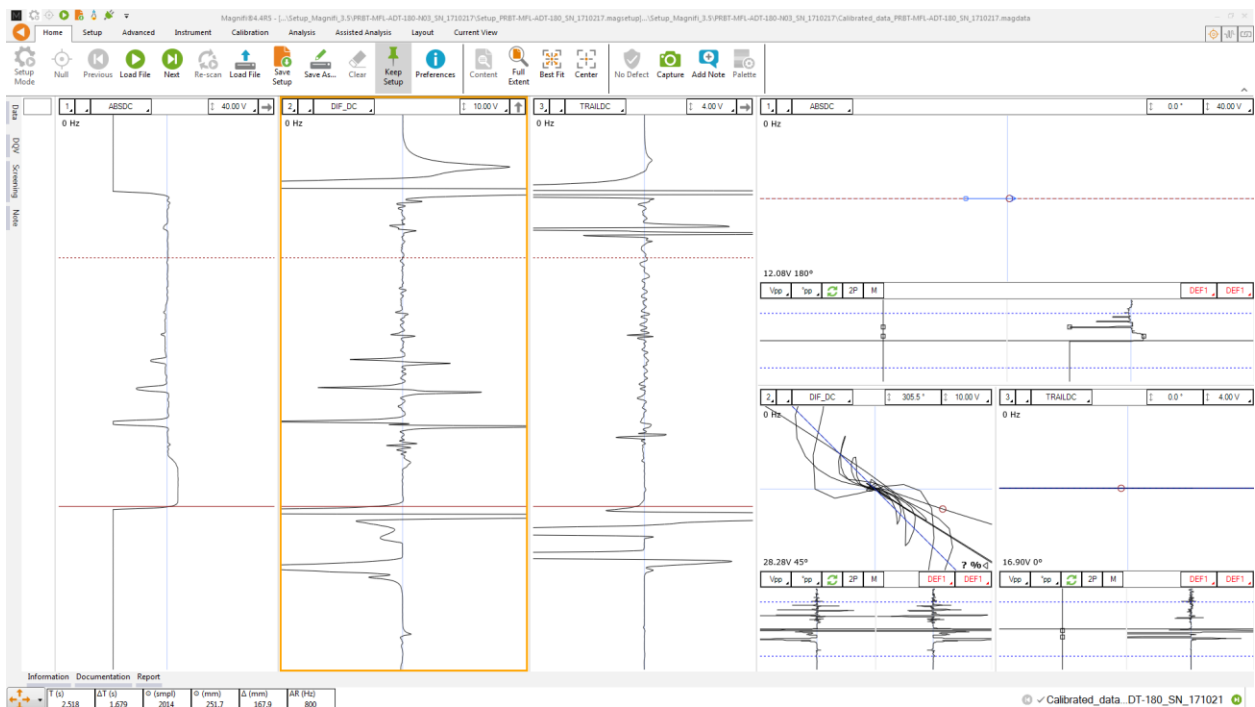

Note that a red zone in the code pane means that at least one of the raw signals is saturated. This is usually the case when your probe is out of the tube.

## VISUALIZING THE DATA

Multiple options are available to select your data and to measure it. The following describes useful functions to do so:

## DISPLAYED CHANNEL

There are four buttons at the upper right corner of the Strip charts and Lissajous windows. These buttons are used for the channel selection.

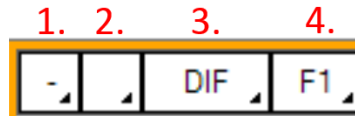

1. Links Strip charts and Lissajous to the same channel. For instance, if a Lissajous and a Strip chart are both set to 1, setting the Lissajous to DIF-F1 will also set the associated Strip chart to this channel.

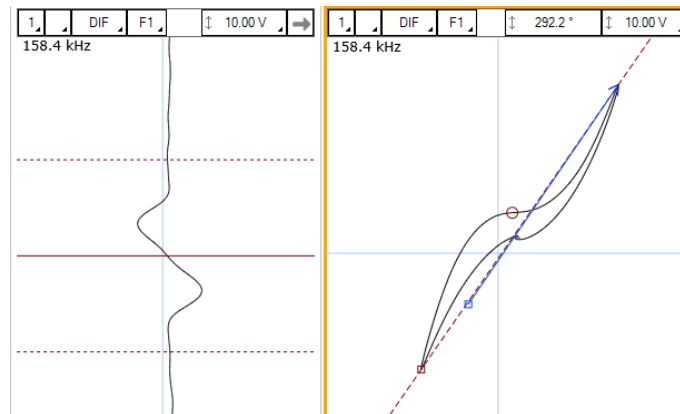

2. Clicking on the corner with the black triangle gives the list of available channels. Click on the desired channel to select it. Right-click or Left-click on this button to switch to the following or previous channel in the list.

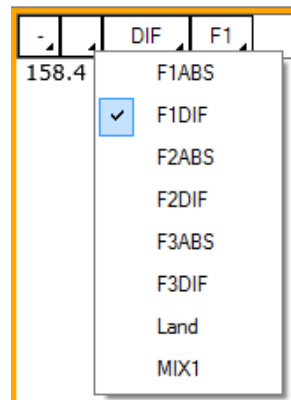

3. Same principle as 2., but for the type of channel only (absolute or differential)
4. Same principle as 2., but for the frequencies only

## STRIP CHARTS AXIS ORIENTATION

The Strip charts are projections of the Lissajous on the vertical or horizontal axis. To switch from one axis to another, click on the box showing an arrow at the upper right corner of the Strip chart.

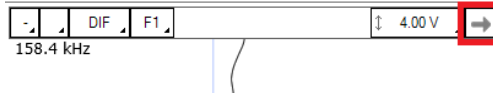

## ZOOMING

On the strip chart, hold the right button of your mouse and drag on the zone of interest to zoom in this section.

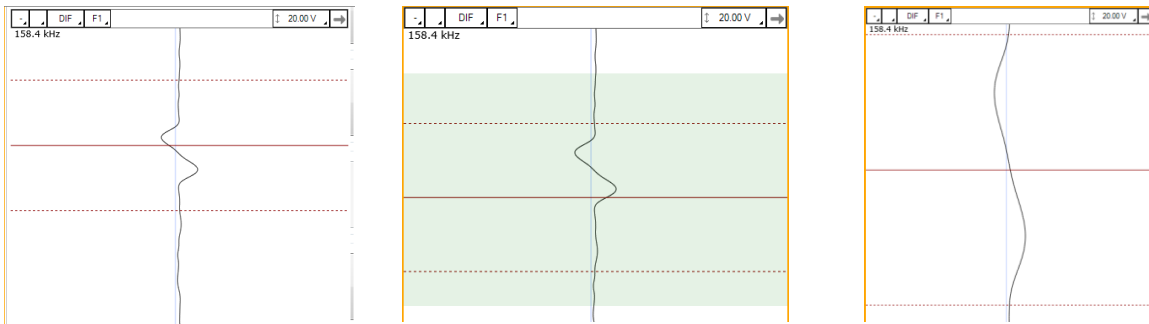

To zoom out, right-click on the Strip chart and select *Previous Zoom* or *Full Extent*.

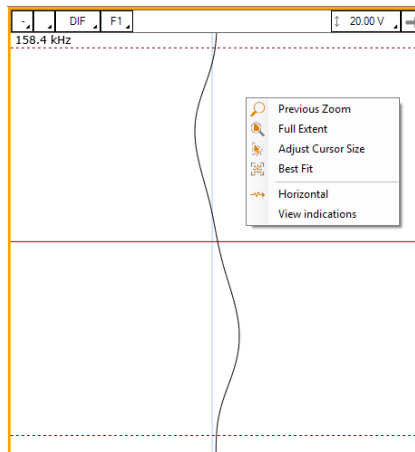

## ADJUSTING THE CURSOR LENGTH

On a Strip chart, the cursor is divided by 3 lines. The dotted lines represent the limit of your cursor and the full line is the center of what you have selected.

Only the portion of data between the dotted lines will be shown in the Lissajous.

To adjust your cursor length, hover your mouse over the dotted line, and click and drag the left mouse button. This will adjust the 2 dotted line symmetrically. To adjust only one dotted line, do the same operation, but with the right button of your mouse.

## ADJUSTING THE SCALE

The scale of a window (Lissajous or Strip chart) can be modified by clicking on the scale button with the left button (decrease scale) or the right button (increase scale) of your mouse.



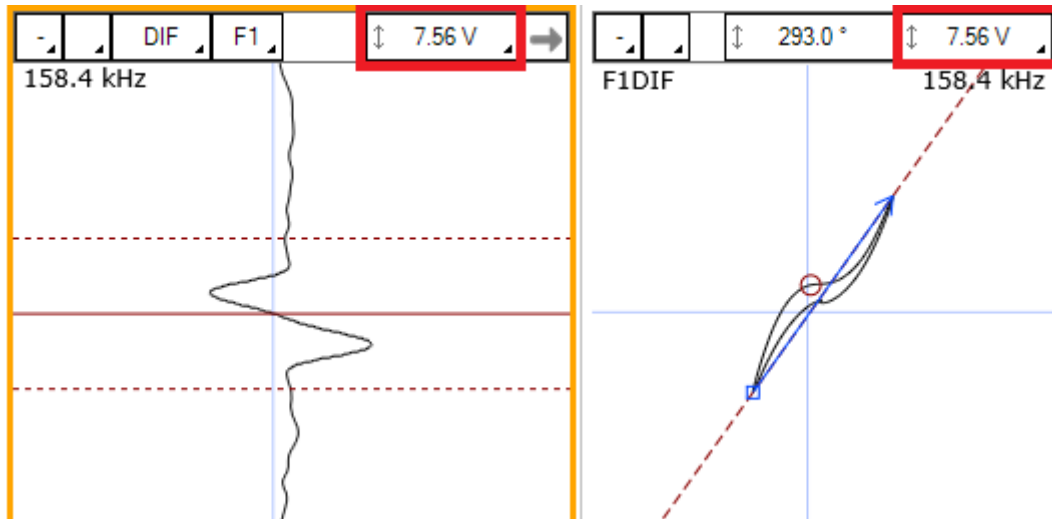

Another way to modify the scale is to click and drag (up or down) the right button of your mouse on the scale button.

## MEASUREMENT METHOD

The buttons at the lower left corner of the Lissajous windows are used to select the measurement method. A short description of the measurement methods can be found in the above calibration section of the setup wizard.



5. Clicking on the corner with the black triangle gives the list of measurement method for the amplitude of the signal. Click on the desired method to select it. Right- or left-click on this button to select the next or the previous method in the list.
6. Same as 1., but for the phase measurement
7. Remove  $180^\circ$  to the measured phase. This option can be used if the software doesn't measure the phase with the right orientation.
8. Take the same two points in time to take the measurement in the other Lissajous.
9. Allow a manual measurement of the signal. Click and drag the left button of your mouse to draw a vector on your Lissajous.

## LISSAJOUS ROTATION AND PANNING

The signal in a Lissajous can be rotated by holding CTRL on the keyboard while holding the left button of your mouse and dragging it around the rotation axis. Note that this operation cannot be performed on the raw channels since these channels have no gain or rotation applied, by definition. Also, rotating the signal will affect your calibration. If you perform this operation, make sure to recalibrate afterwards.

The origin point can also be moved by holding the left button of your mouse on the Lissajous background and by dragging it in the desired direction.

## DATA CENTERING

To center the data in the different windows, put your cursor at a point where you want the data to be centered and use the spacebar on the keyboard.

## CALIBRATION AND SIZING CURVES

---

### SLEW

The MFL probes include two bobbins that generate absolute and differential channels. It also includes a *Trail* bobbin. Since the *Trail* is not physically located at the same position as the other coils, there is a time delay between the *Differential/Absolute* channels, and the trail channel. To bring all the signals at the same position, the trail channel can be shifted in time to match the other channels. This process is called *Slew* in Magnifi.

To Slew:

1. Click on the *Slew* button that can be found under the *Calibration* tab.

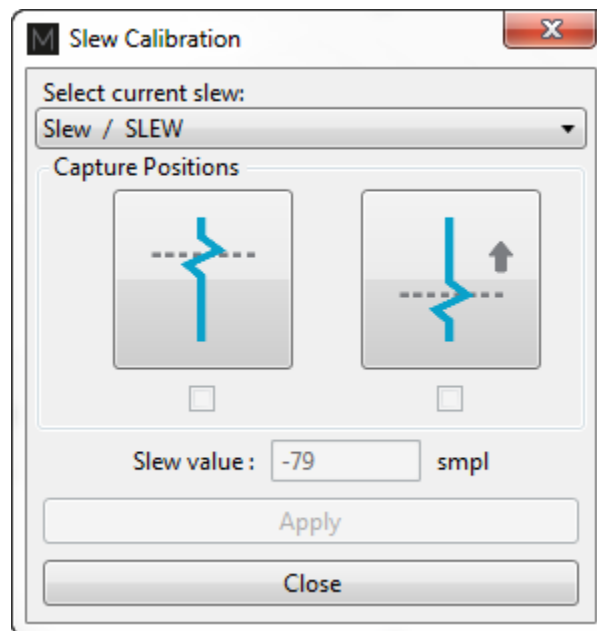

2. Place your cursor over a flaw in the strip chart of a *Differential* channel.
3. Click on the button at the left in the *Slew Calibration* window. This will set the reference point at which the channels will move.
4. Place your cursor over the same flaw but on the strip chart of the *Trail* channel.
5. Click on the button at the right in the *Slew Calibration* window.
6. Click on *Apply*.

Note that this process will move the channels by a constant number of samples. Therefore, a probe pulling speed that was not constant won't have a data alignment that is valid throughout the hole scan.

## CALIBRATION

The following section describes how to calibrate your probe.

1. Go to the *Calibration* tab and click on the *System* icon.
2. Select Channel in the calibration window.
3. In the Strip chart, select the signal to calibrate and adjust the cursors to see only the desired signal.

Note: The system calibrates the signal with a measurement method that is defined in the calibration part of the setup (previous step). It is recommended to read the data with the same method as the system when you select your calibration point. This will allow you to see what the system is using to make its calibration. If, for some reason, the measurement is not taken properly, you may be able to readjust your cursor to have the right measured values.

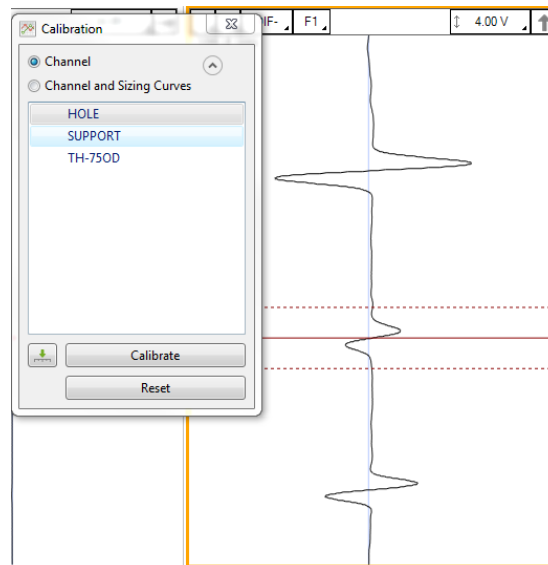

4. Select the signal name in the list
5. Click on the green arrow button to associate the measured signal to the calibration point.
6. If more than one calibration point is present in the list, repeat step 3, 4 and 5 for each one.
7. When all your calibration points are check-marked, click on the *Calibrate* button.

## SIZING CURVES

The following section describes how to build your sizing curves.

1. Go the calibration tab and click on the *Sizing curve* button.
2. Select *Channel and Sizing Curves* in the *Calibration* window.
3. Select the signal in your Strip chart and adjust the cursors to see only the desired signal.

Note: The system calibrates the signal with a measurement method that is defined in the calibration part of the setup (previous step). It is recommended to read the data with the same method as the system

when you select your calibration point. This will allow you to see what the system is using to make its calibration. If, for some reason, the measurement is not taken properly, you may be able to readjust your cursor to have the right measured values.

Also, when points are entered in the sizing curves, the interpolated value is displayed on the Lissajous to show the defect size. To have the correct interpolated point, the measurement method also needs to be the same as the one used for the sizing curve. To change the measurement method, click on the icons at the bottom left of the Lissajous.

1. Select the signal name in the list.
2. Click on the green arrow.
3. Redo the previous steps for all the other indications in the list.
4. Click on the Calibrate button.

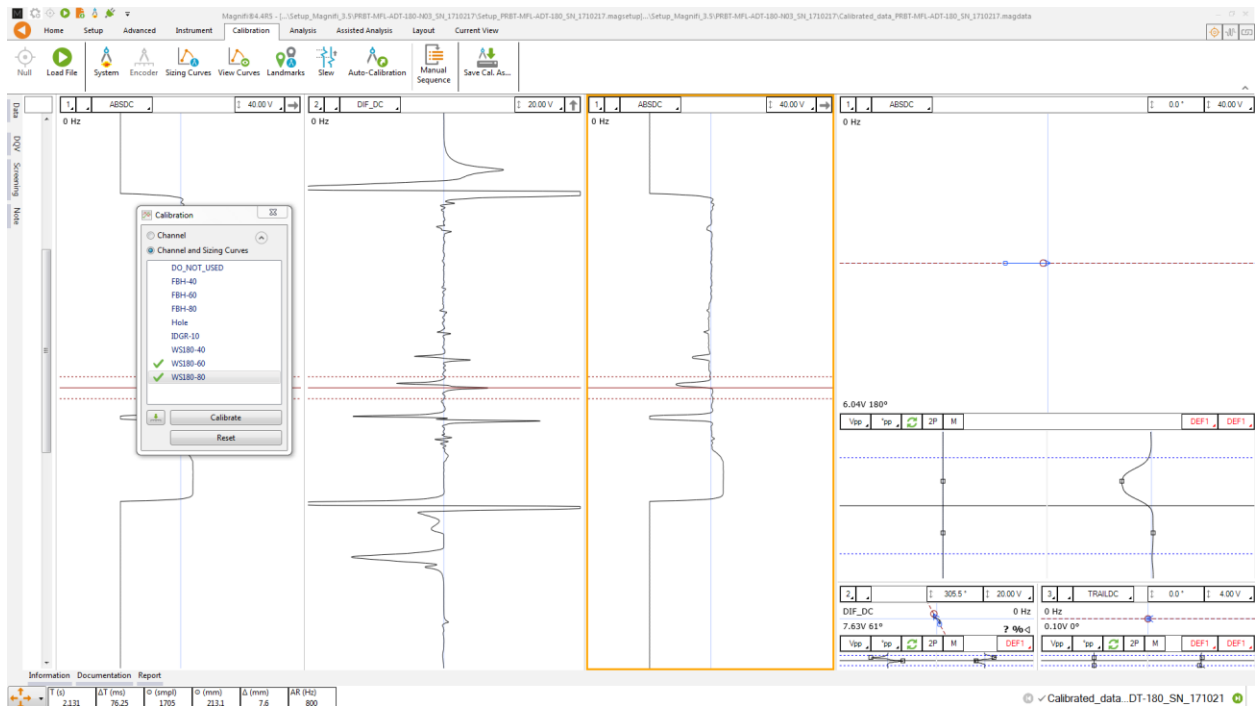

Sizing curves can also be adjusted manually. To do so, go the *Calibration* tab, and click on *View Curves*. The sizing curve window will appear. Each sizing curve you asked Magnify to create will be listed in the drop-down menu. If an invalid notification is present on the curve, it means that you either haven't entered the sizing points yet or that Magnifi failed to create the curve. To adjust the sizing curve manually, enter the value in the table.

To validate the curves, you can bring the measurement cursor over one of the calibrated flaws in the Lissajous and get an estimation of the depth (shown in the lower right corner). If the flaw size does not appear, it means that you are not in a channel where a sizing curve was set.

## LANDMARKS

The following section describes how to calibrate your landmarks.

Go to the calibration tab and click on the Landmark icon. Calibrate the landmarks shown in the *Landmarks* window the same way as you calibrated the sizing curve(s) points. You can use the *Land* channel to do so. The positions of TS1 and TS2 are described in the *Landmark* window in the *Setup* tab (TS2 is the farside tubesheet, that is, the first one encountered by the probe during data acquisition; TS1 is the nearside tubesheet).

Once the landmarks are calibrated properly the system should be able to recognize them automatically.

Note that in order to calibrate the default *Exit* landmark, a datafile that includes the probe exit at the far end of the tube is needed.

## SAVING YOUR SETUP

Once all your setup adjustments are done, you can save your setup by clicking on the *Save Setup* button under the *Home* tab. The displayed window will allow you to give an appropriate name to your setup and to save it at the desired locations. The save location is, by default, your inspection file. Note that when data is saved, the setup is also saved with it.

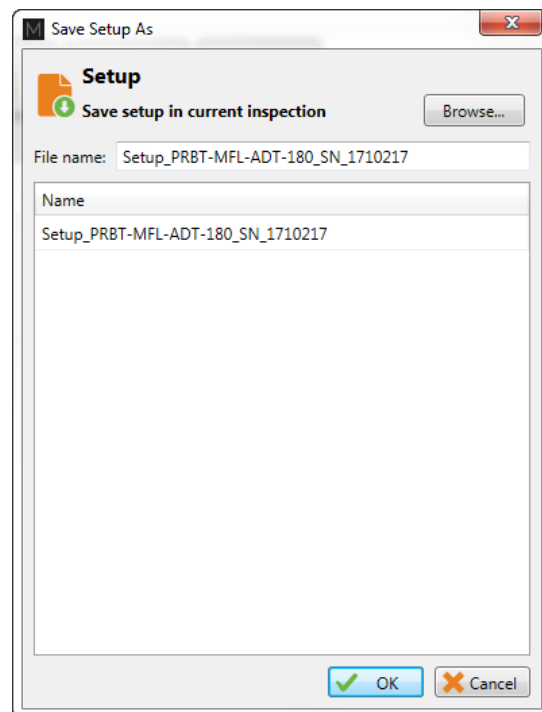

You can also save the data of your calibration standard by clicking on the *Save As* button under the *Home* tab.

### STANDARD ACQUISITION

The following section describes how to perform an inspection.

5. Connect Magnifi to your instrument.
6. Enter into *Acquisition Mode* by clicking on the *Setup Mode* button under the *Home* tab. *Acquisition Mode* is activated when the *Setup Mode* button is not grayed.
7. Plug the MFL probe into the Ectane 19-pin connector.
8. Bring the probe head to a clear area in your standard and balance the probe by clicking on the *Null* button under the *Home* tab, or press F6 on your keyboard.
9. Push the probe all the way through the tube until it exits the far end.
10. Start the acquisition by clicking on the *Acquire* button under the *Home* tab or by pressing the F2 on your keyboard.
11. Pull the tube towards you at approximately 1m/s (40"/s).
12. When finished, press the *Stop* button or again F2 on your keyboard.
13. Repeat steps 4,5,6 and 7 for all the tubes to inspect in your bundle.

### MANUAL SEQUENCE

An inspection can also be done by using the manual sequence. This feature is based on the landmarks and can trigger the acquisition start/stop and the data recording automatically. At least two landmarks are needed to use this feature. These landmarks can be created by using the Landmarks button under the SMART Setup tab.

To set the manual sequence:

1. Click on the *Manual Sequence* button under the *Calibration* tab.
2. If a warning message is shown in this window, change the parameters until no warnings are shown. The system will progress through the different windows to guide you.
3. Click on *Settings ...*

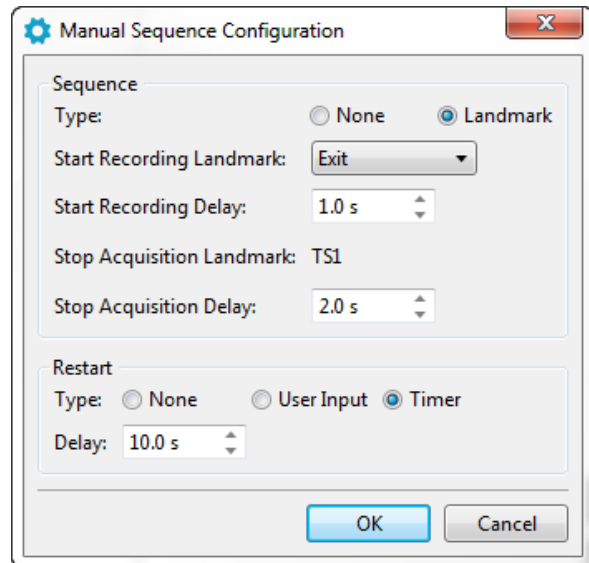
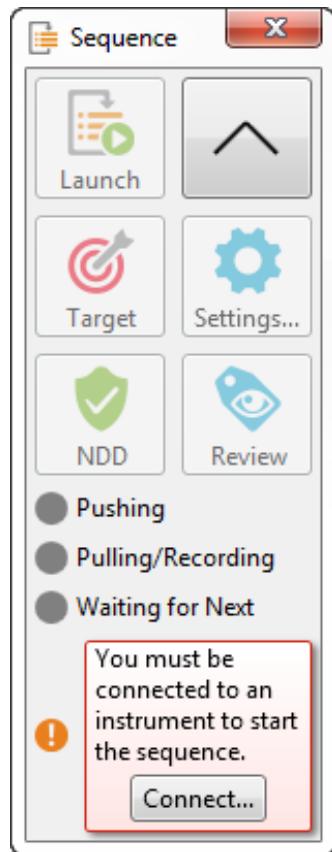

4. Select *Landmark* in the *Type* section.
5. In the drop-down menu, choose the Landmark that will initiate the data recording. If you keep the default landmarks, you can select the *Exit* landmark that will be triggered when the probe goes out of the tube when the probe is pushed.
6. You can enter a delay to start the acquisition after the first landmark is detected (*Start Recording Delay*) and a delay to stop the acquisition when the last landmark is detected (*Stop Acquisition Delay*).
7. Two options are available to restart the acquisition: The user can either push a button or use a timer. Select the desired option in the *Restart* section.
8. Click on *OK*.

To use the manual sequence:

9. Connect Magnifi to the instrument.
10. Enter into *Acquisition Mode* by clicking on the *Setup Mode* button under the *Home* tab. *Acquisition Mode* is activated when the *Setup Mode* button is not grayed.
11. Plug the MFL probe into the Ectane 19-pin connector.
12. Bring the probe head to a clear area in your standard and balance the probe by clicking on the *Null* button under the *Home* tab, or press F6 on your keyboard.
13. Open the *Sequence* window by clicking on the *Manual Sequence* button under the *Calibration* tab

14. Put your probe in the tube to inspect and click on the *Launch* button. This will start the data acquisition.
15. Push the probe until it exits the far end of the tube. If set correctly, Magnifi will recognize the landmark and this will initiate the data recording.
16. Pull the probe towards you until it exits the tube. This will trigger the last landmark detection that will stop the data recording.
17. Acquisition restart:
  - a. If you selected *User Input* in the settings of the *Manual Sequence Configuration*, the system will wait for the user to enter information on the tube to restart the acquisition. Click on *NDD* or *Review*. This will add a tag to the inspected tube and it will restart the acquisition. Repeat steps 6, 7 and 8 for all the tubes to inspect.
  - b. If you selected *Timer* in the settings of the *Manual Sequence Configuration*, a countdown will trigger after the last tube acquisition was taken. The acquisition will start after this time has elapsed. Redo step 6 and 7 for all the other tubes to inspect in the bundle.

When doing your inspection, you may encounter some tubes that can't be scanned completely. If this is the case, you won't be able to catch the landmark that triggers the data acquisition at the end of the tube. In this situation, you can click on the *Target* button in the *Sequence* window to start the data recording.

## DATA LIST MANAGEMENT

For each acquisition, Magnifi can automatically save a file using the file name defined previously in the *Tube list* section of this document. To do so, checkmark the *Automatic File Recording* option that can be found under the *General tab* of the *Preference* menu of the *Backstage*.

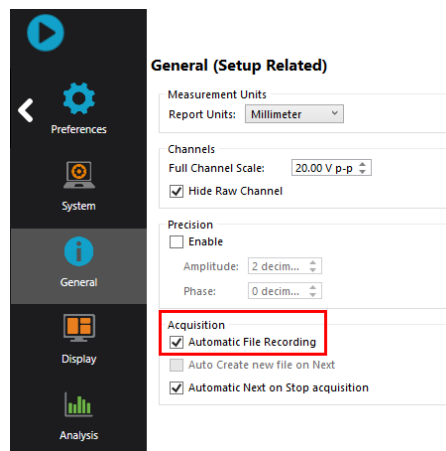



The list of tubes is also shown in the *Data* window.

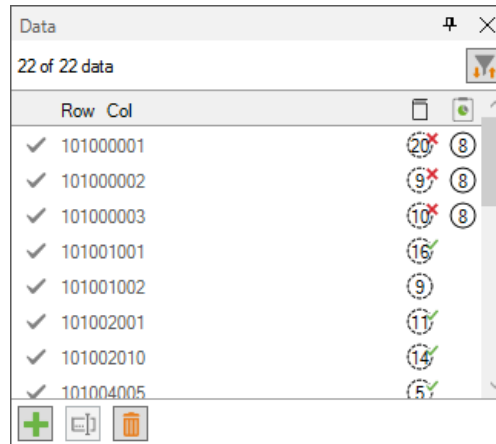

A common practice is to rescan your calibration tube and balance the probe periodically. You can save this new calibration tube data by adding a new tube in your tube list (999 001 for example). Or you can go out of the acquisition mode, scan your tube, and click on the *Save Cal As...* button under the *Calibration* tab to save your data. You can then go back to *acquisition mode* to continue your inspection and to automatically save the acquired tubes in your bundle.

Once a tube has been scanned, the "play" icon next to the file name will be replaced with a checkmark icon.

You can rescan a tube by selecting its name in the list and by clicking on the *Rescan* button in the *Home* tab.

A tube name can be changed by right-clicking on its name and by selecting the *Rename* option.

## LOADING A FILE

18. First disconnect your computer from the Ectane by clicking on the *Disconnect* button under the *Home* tab.
19. You can load a file by double-clicking on the file name in the *Data* window. It can also be done by selecting the file in the list and by clicking on the *Load* button under the *Home* tab. Note that double-clicking on a tube when you are still connected to an instrument will initiate data acquisition.
20. You can open the next or the previous file in the list by clicking on the *Previous* or *Next* button of the *Home* tab.

The data files can be filtered by using the *Filter* button of the *Data* window.

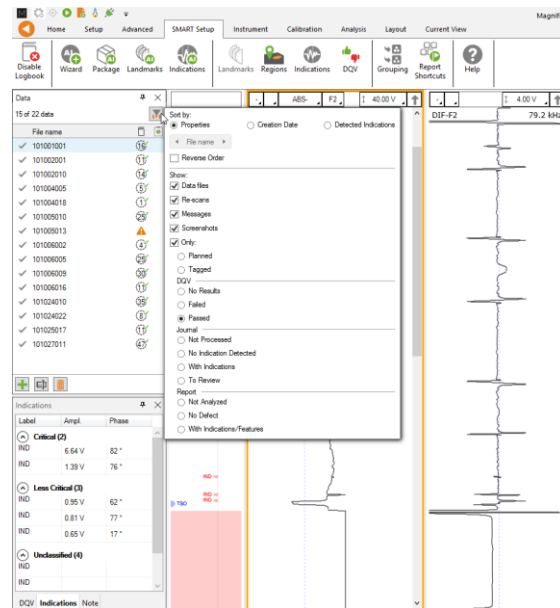

## REPORT

### INDICATIONS

The two *Indication* buttons at the lower corner of the Lissajous windows can be used to add an entry to the report. These two buttons indicate the code that is associated with the defect being entered. Both buttons are identical, but can be set to identify different flaws.

To add an indication to the data:

1. Select the defect signal in the strip chart and adjust the cursor so that the signal in the Lissajous includes only the defect signal.
2. Then, click on the red triangle in the corner of the *Indication* button to select the type of defect to enter.
3. Click on the defect button to add an entry to the report.

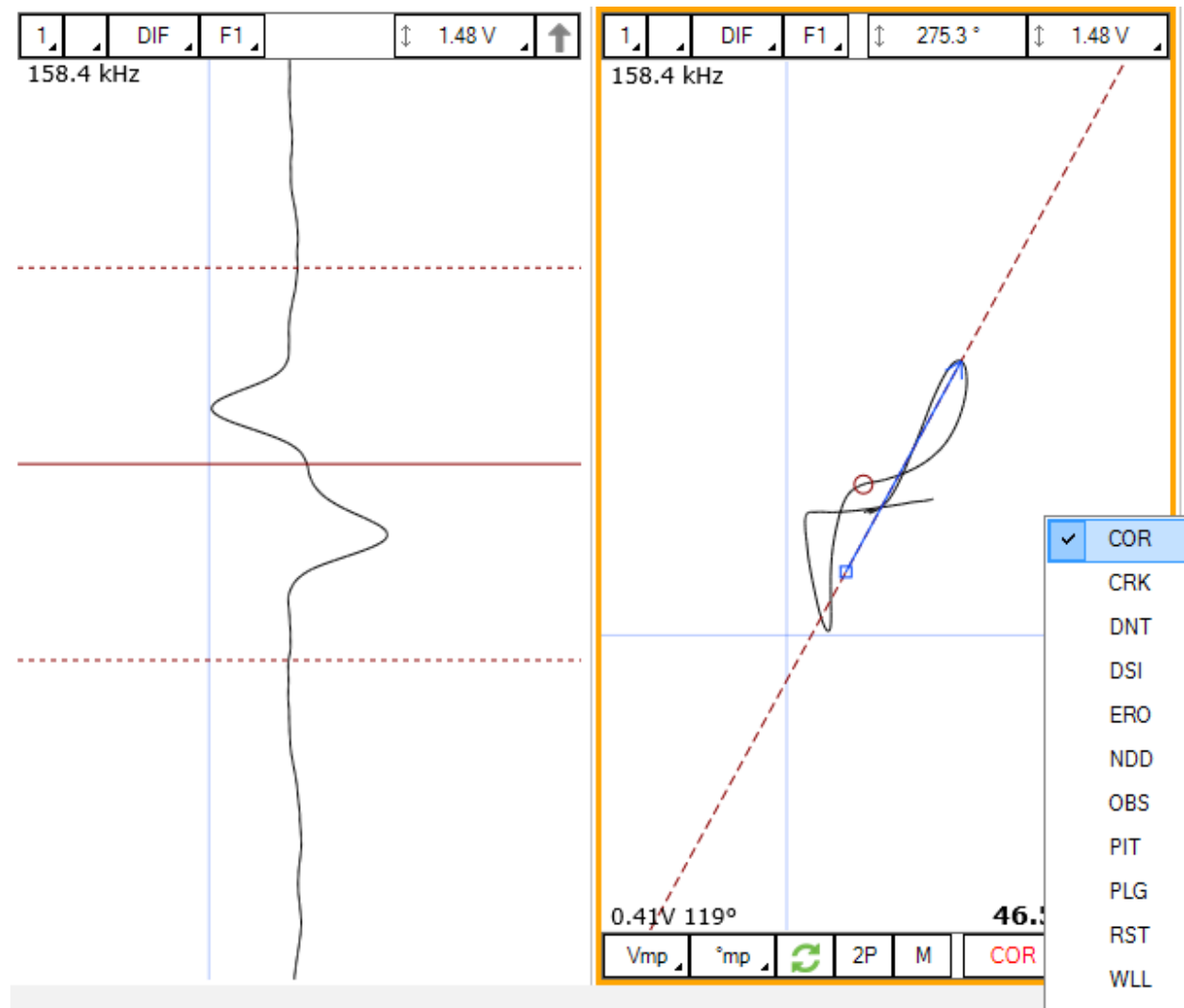

Report Entries can also be added with keyboard shortcuts. How to set up these keyboard shortcuts is explained in the SMART Setup section of this manual.

Indications can also be added to a tube to indicate, for instance, that it has no flaw or that it is plugged.

To add an indication to a tube:

1. Load the file
2. Click on the appropriate indication button available under the Analysis tab

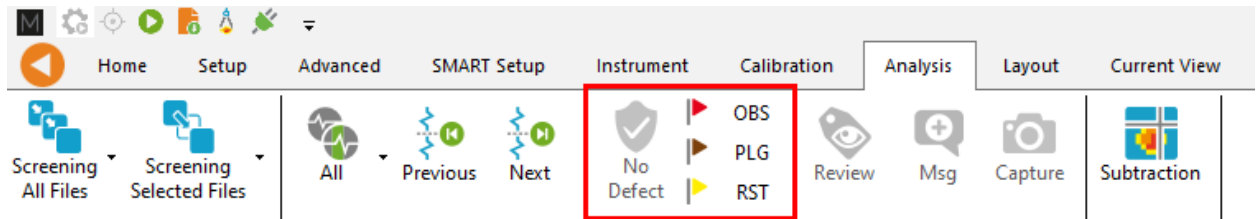

## REPORT TABLE

To access the list of indications entered:

1. Make sure that the Report option is selected under the Layout tab.

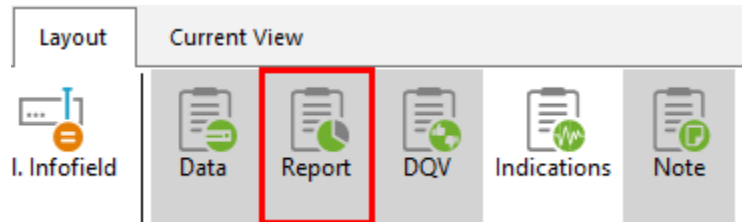

2. Click on the report ribbon at the bottom of the screen to make the list visible

Zone	Row	Col.	Code	Size	Side	Ampl. (V)	Angle (°)	Channel/C-scan	Y pos. (mm)	LMK Y pos.	Offset Y pos. (mm)	Y leng. (mm)	Comment
1	0	0		0.00		0.00	0		0.0		0.0	0.0	
2	0	0		0.00		0.00	0		0.0		0.0	0.0	

Entries in the report can be modified by changing the value in the table. You can also delete an entry by clicking on the X next to it.

## REPORT GENERATION

Magnifi can automatically generate a full report with the report table.

To generate this report:

1. Go to the *Backstage* by clicking on the arrow at the upper left corner of the *Frontstage*.
2. Click on the *Generate Report* button under the *Report* section of the *General* tab.

- Choose your preferences and enter the required parameters. The *# of tubes in component* is used to show the percentage of tube in each category.

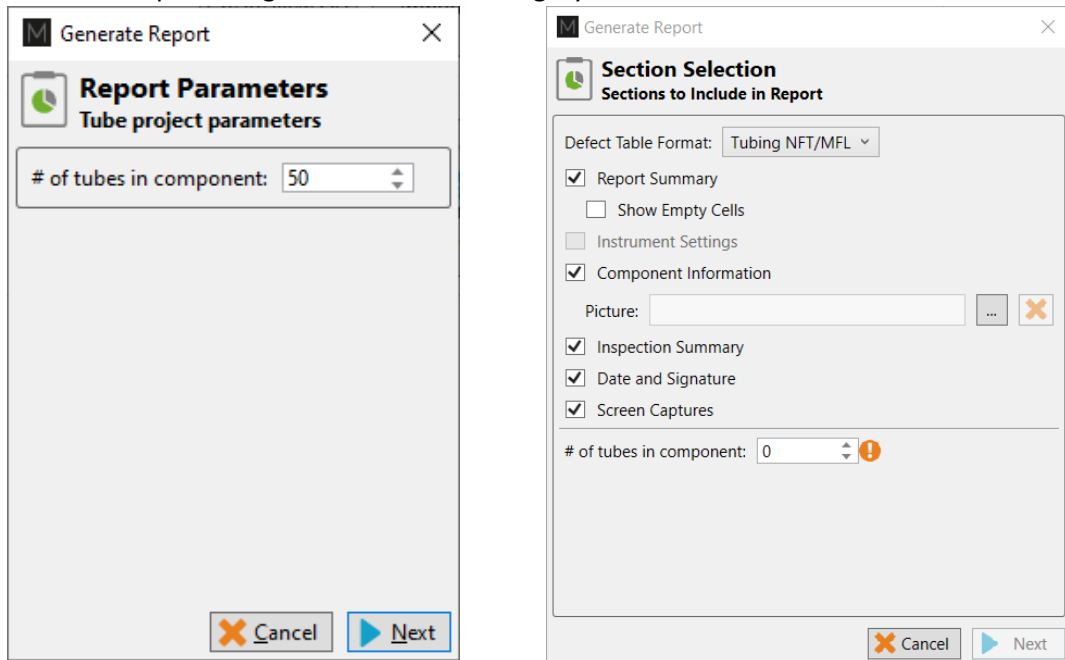

- Click Finish to generate the report.

Once generated, the report is saved as a .html file in the current Inspection sub-directory. It can be viewed using any regular web browser.

There is a “copy” button next to each element of the report such as tables and images. When clicking on it, the element will be copied to the clipboard. It can then be pasted to another file such as an Excel or Word.

The screenshot shows the 'Analysis Report' web interface. The left sidebar contains navigation options: Instrument Settings, Channels, Channel Calibrations, Mix Channels, Component Information, Inspection Summary, Indication Table, Inspection, and Data. The main content area is titled 'Analysis Report' and shows 'Instrument Settings' with a copy icon. Below it, the 'Channels' section contains a table with the following data:

Name	Frequency (KHz)	Drive (V)	Gain (dB)	Low Pass (KHz)	High Pass (Cnt)
R_ABS-F1	160.0	2.50	46.0	400	
R_ABS-F2	80.0	2.50	46.0	400	
R_ABS-F3	40.0	2.50	46.0	400	
R_ABS-F4	20.0	2.50	46.0	400	
R_DIF-F1	160.0	2.50	46.0	400	
R_DIF-F2	80.0	2.50	46.0	400	
R_DIF-F3	40.0	2.50	46.0	400	
R_DIF-F4	20.0	2.50	46.0	400	

The Print button, bottom right corner on image above, can be used to either print a paper copy of the whole report or to save it as a .pdf document. The PDF generator available with the current web browser will be used.

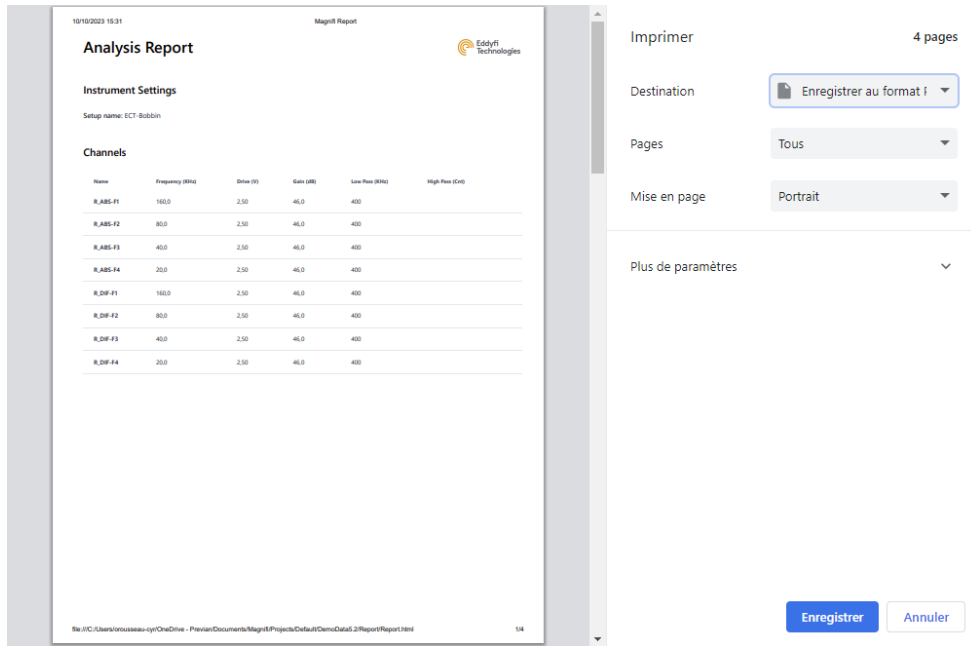

The report logo can be modified by clicking on the *Select Company Logo* that can be found under the *System* tab of the *Backstage*.

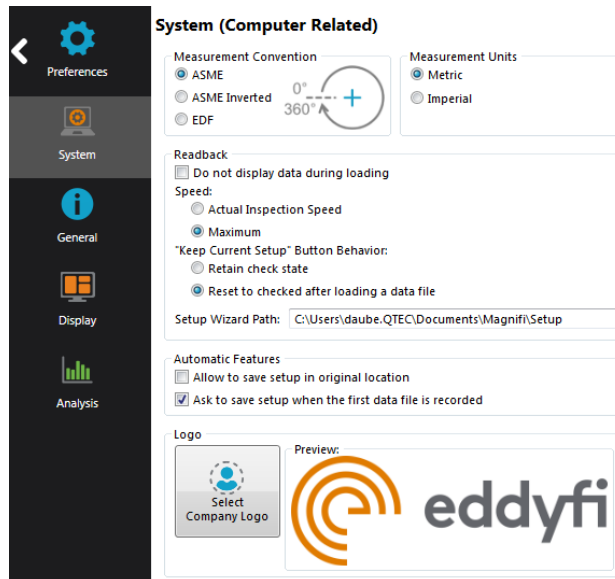

The report table file in the *Inspection* folder can also be imported into other reporting software such as *TubePro*.

# IRIS Application Guide





## INTRODUCTION

---

This document presents how to use an Eddyfi IRIS system with Magnifi on an Ectane test instrument.

Eddyfi offers five types of IRIS centering devices. The following was made using a small centering device but can also be applied to other types of IRIS centering devices.

For illustration purposes, we used a SS316 tube 25.4 mm (1 in) in outside diameter (OD) and 1.96 mm (0.077 in) in wall thickness.

## TERMINOLOGY

---

### PROBE DELAY (PD)

Corresponds to the transit time of the ultrasonic pulse to reach the mirror (typically 20  $\mu\text{s}$  to 23  $\mu\text{s}$ )

### TUBE INTERNAL RADIUS (IR)\*

Corresponds to the pulse transit time through water (from the mirror to the front wall)

*\* This explanation assumes a stationary mirror, thus we use internal "radius" instead of "diameter"*

### TUBE WALL THICKNESS (WT)

Corresponds to the pulse transit time through the metal. Time in between front wall and back wall

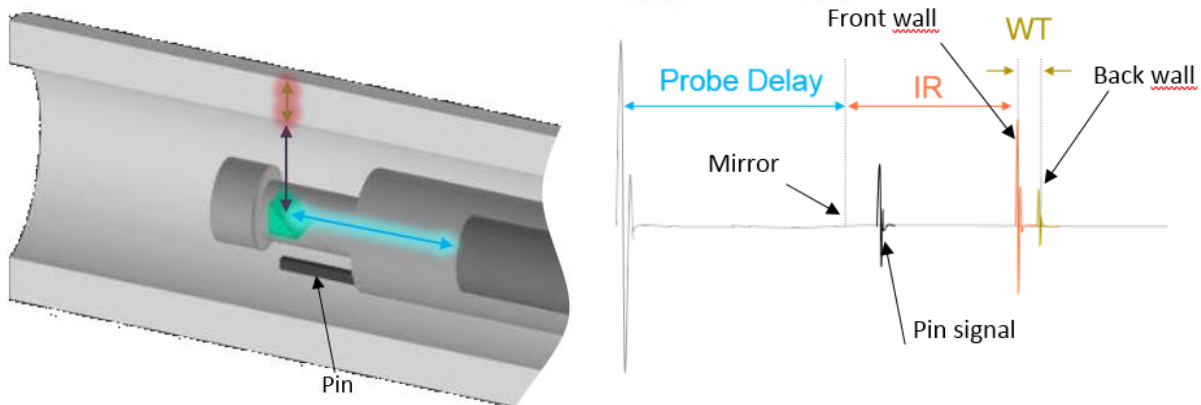

## EQUIPMENT

---

### CENTERING DEVICE



### ULTRASONIC TRANSDUCER



### TURBINE



### IRIS PUMP



### CABLES



## SELECTION

Select your hardware according to the following tables.

Example:

- CDSL-SLA: Small centering device
- TB-170: 17.0 mm (0.67 in) turbine
- TD-15M-254: 15MHz, 25.4 mm (1 in) focal length transducer

IRIS selection table for tubing:

		TUBE WALL THICKNESSES									
		BWG	4	6	8	10	12	14	16	18	20
		MM	IN	MM	IN	MM	IN	MM	IN	MM	IN
OUTER DIAMETERS	MM	IN	0.238	0.206	0.165	0.135	0.109	0.083	0.065	0.049	0.035
	12.70	0.500	-	-	-	-	-	-	CDXS-SLA TB-085 MTD-20M-191	CDXS-SLA TB-085 MTD-20M-191	-
	15.87	0.625	-	-	-	-	CDXS-SLA TB-085 MTD-20M-191	CDXS-SLA TB-085 MTD-20M-191	CDXS-SLA TB-120 TD-20M-254	CDXS TB-120 TD-20M-254	CDXS TB-120 TD-20M-254
	19.05	0.750	-	-	CDXS-SLA TB-085 MTD-20M-191	CDXS-SLA TB-085 MTD-20M-191	CDXS-SLA TB-120 TD-15M-254	CDXS-SLA TB-120 TD-15M-254	CDXS-SLA TB-120 TD-20M-254	CDXS-SLA TB-120 TD-20M-254	CDXS-SLA TB-120 TD-20M-254
	22.22	0.875	CDXS-SLA TB-085 MTD-20M-191	CDXS-SLA TB-085 MTD-20M-191	CDXS-SLA TB-120 TD-10M-254	CDXS-SLA TB-120 TD-15M-254	CDXS-SLA TB-120 TD-15M-254	CDXS-SLA TB-120 TD-15M-254	CDXS-SLA TB-120 TD-20M-254	CDXS-SLA TB-120 TD-20M-254	-
	25.40	1.000	CDXS-SLA TB-120 TD-10M-254	CDXS-SLA TB-120 TD-10M-254	CDXS-SLA TB-120 TD-10M-254	CDXS-SLA TB-120 TD-15M-254	CDSM-SLA TB-170 TD-15M-318	CDSM-SLA TB-170 TD-15M-318	CDSM-SLA TB-170 TD-20M-318	CDSM-SLA TB-170 TD-20M-318	-
	31.75	1.250	CDSM-SLA TB-170 TD-10M-318	CDSM-SLA TB-170 TD-10M-318	CDSM-SLA TB-170 TD-10M-318	COMD TB-170 TD-15M-318	COMD TB-170 TD-15M-318	COMD TB-170 TD-15M-318	COMD TB-170 TD-15M-318	-	-
	38.10	1.500	COMD TB-170 TD-10M-318	COMD TB-170 TD-10M-318	COMD TB-170 TD-10M-381	COMD TB-170 TD-15M-381	COMD TB-170 TD-15M-381	COMD TB-170 TD-15M-381	COMD TB-170 TD-15M-381	-	-
	50.80	2.000	COLG TB-170 TD-10M-381	COLG TB-170 TD-10M-381	COLG TB-170 TD-10M-445	COLG TB-170 TD-15M-445	COLG TB-170 TD-15M-445	COLG TB-170 TD-15M-445	COLG TB-170 TD-15M-445	-	-
	63.50	2.500	COLG TB-170 TD-10M-445	COLG TB-170 TD-10M-508	COLG TB-170 TD-10M-508	COLG TB-170 TD-15M-508	COLG TB-170 TD-15M-508	COLG TB-170 TD-15M-508	-	-	-
76.20	3.000	COLG TB-170 TD-10M-508	COLG TB-170 TD-10M-508	COLG TB-170 TD-10M-508	COLG TB-170 TD-15M-508	COLG TB-170 TD-15M-508	COLG TB-170 TD-15M-508	-	-	-	

IRIS selection table for piping:

		UT TRANSDUCERS (MHZ, MM, IN)														
DIMENSIONS						10			15			RECOMMENDED SPEEDS			SMALLEST DETECTABLE DEFECT (TYP.)	
NPS	OD		WALL THICKNESS			63.5	76.2	88.9	63.5	76.2	88.9	ROT.	PULL		MM	IN
	MM	IN	SCH	MM	IN	2.5	3.0	3.5	2.5	3.0	3.5	RPS	MM/S	IN/S		
3	88.9	3.500	10	3.05	0.120				●			83	50.8	2.0	4.3	0.169
			40	5.49	0.216							55			4.0	0.157
			80	7.62	0.300	●							57	53.3	2.1	3.8
3½	101.6	4.000	10	3.05	0.120	●			●			48	45.7	1.8	5.0	0.197
			40	5.74	0.226							50			4.7	0.185
			80	8.08	0.318	●							51	48.3	1.9	4.4
4	114.3	4.500	10	3.05	0.120	●				●		44	40.6	1.6	5.6	0.220
			40	6.02	0.237		●					45			43.2	1.7
			80	8.56	0.337		●					47	5.0	0.197		
5	140.6	5.563	10	3.40	0.134						●	37	33.0	1.3	7.0	0.276
			40	6.55	0.258			●				38			35.6	1.4
			80	9.53	0.375			●				39	6.3	0.248		
6	168.3	6.625	40	7.11	0.280			●				33	30.5	1.2	8.0	0.315
			80	10.97	0.432			●				34			7.6	0.299

## PROJECT AND INSPECTION FOLDERS

---

In this section, we will create a folder structure that will manage the save locations of your setup, data and report. This management is operated through the creation of a project.

Magnifi suggests two levels of file. The first level is the Project folder. It is meant to include different inspections that are related in some way. For instance, it can include all the inspections done at a refinery shutdown and be named `Refinery_Shutdown_May_2018`. The second level of file is the Inspection subfolder. Inspection subfolders are saved in the project folder. An inspection subfolder can include the data specific to the inspection of a bundle of tubes with a specific technology and could be named `SS316_075x0.065_ECT` for instance. This inspection subfolder regroups the setup, the tube list, the data and the Magnifi report.

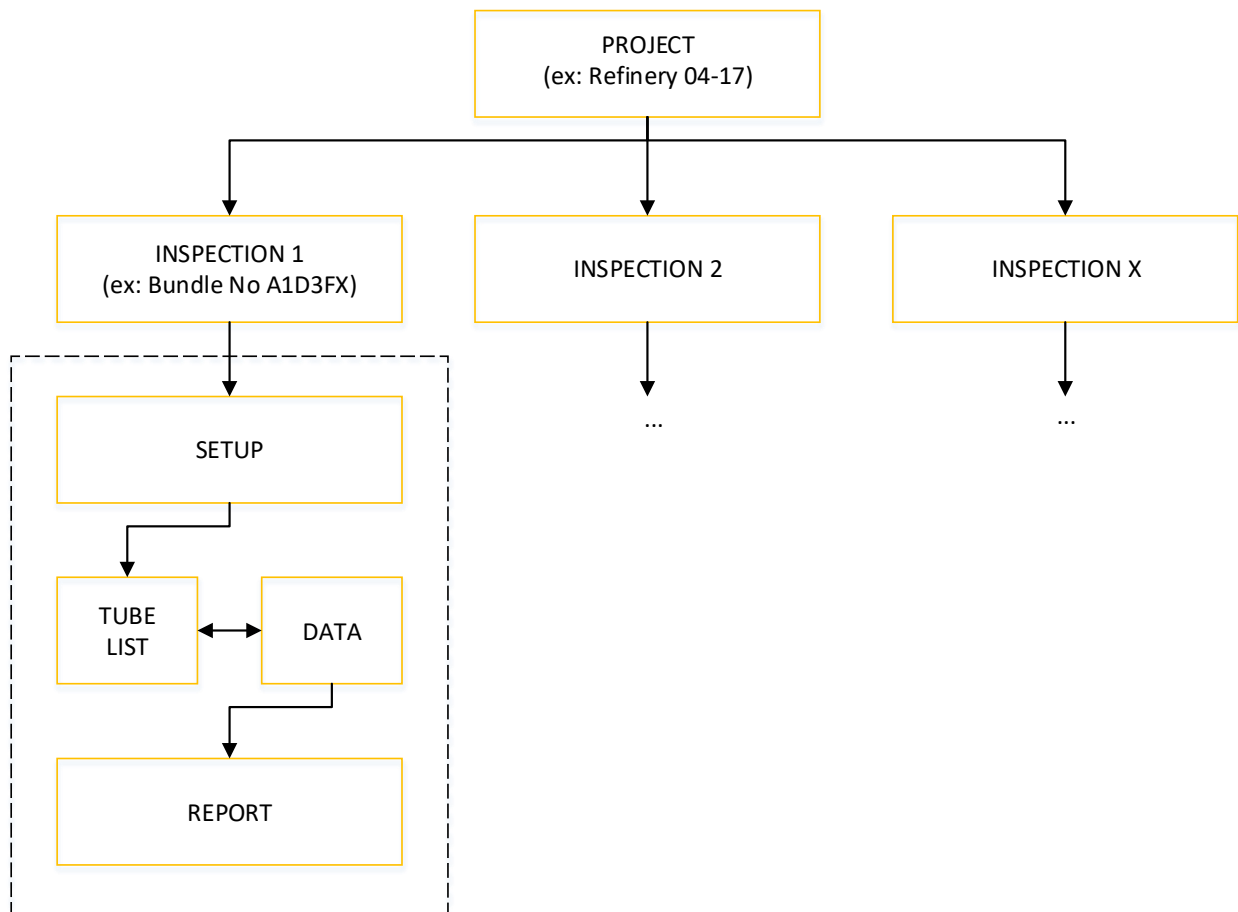

When you open Magnifi, the first page displayed is called the Backstage.

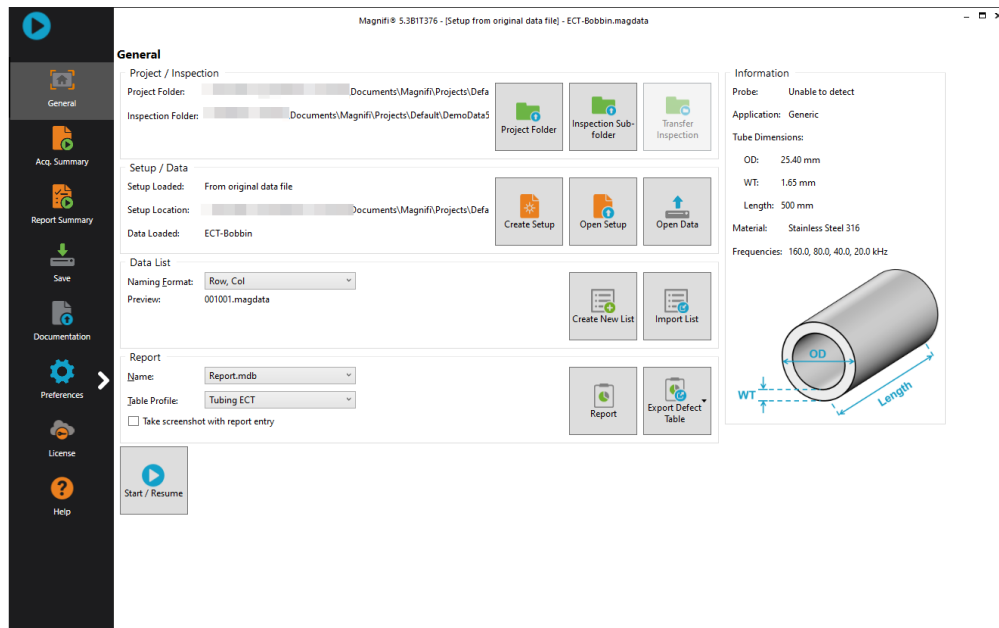

To create or open a project, click on *Open/Add Project* in the backstage. You can select an existing project/folder or you can create a new folder.

1. Create a folder by right-clicking on the location where you want to add your Project file. Select *New, Folder* and enter the chosen name. You can then select the newly created folder and click on *Select Folder*.

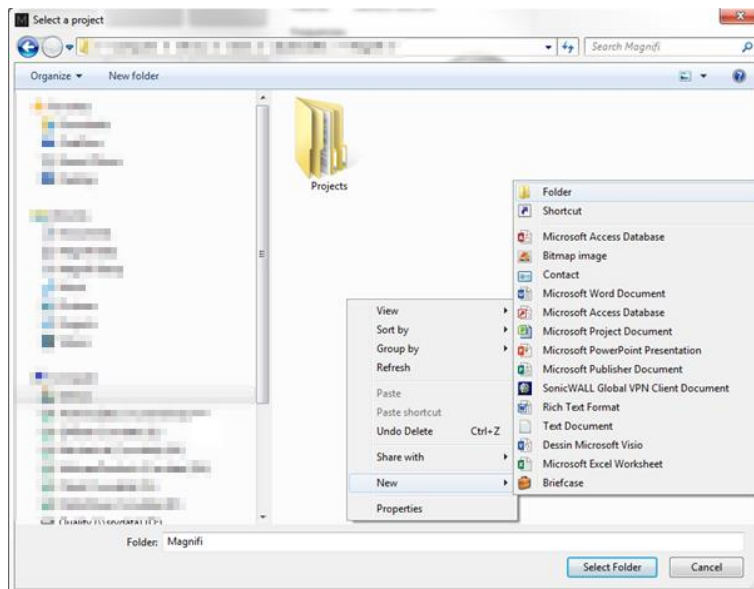

2. Click on *Add/Open Inspection* in the backstage, then click on *Add* and enter the name of your inspection.

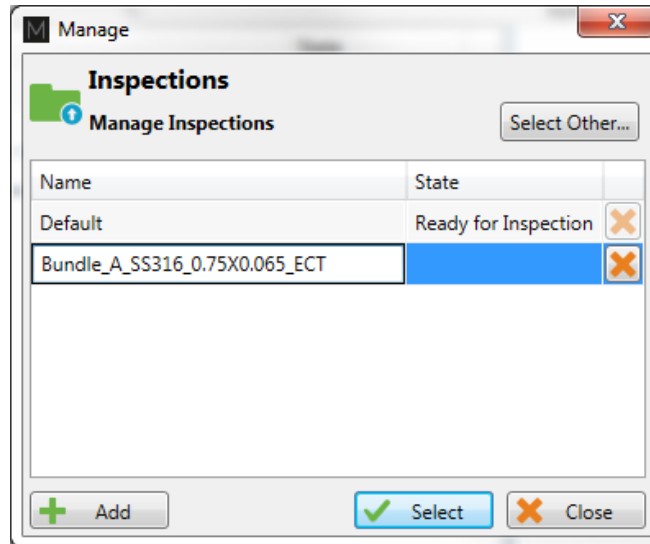

3. Click *Select*. This will define the position where the setup(s) and data will be saved.

## SETUP WIZARD

In this section, we will show how to create a setup using the *Setup Wizard* in Magnifi.

Before going further, you can change the measurement unit. To do so, click on *Preferences*. In the *System* tab, you can change the measurement units from metric to imperial and vice versa. For the metric units, you can choose to use meters, centimeters, or millimeters in the *General* tab. The default measurement for imperial units is inches. When finished, click on *Preferences* again to go back to the *General* window.

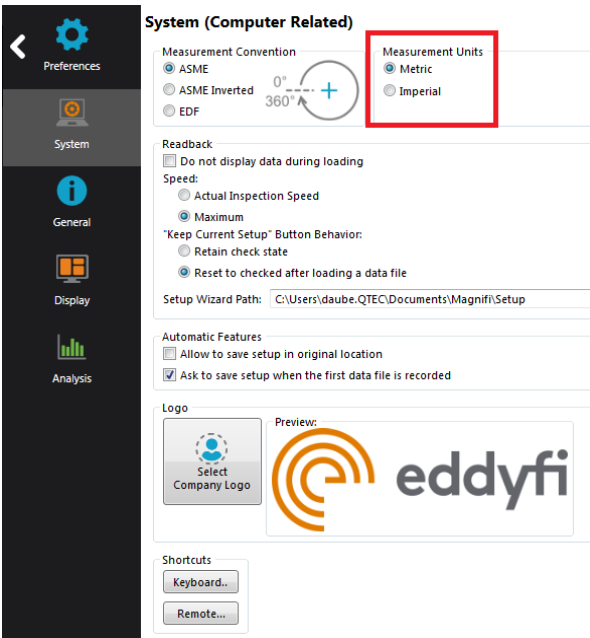

To create a new setup, it's strongly suggested to use the Wizard option menu. Click on *Create Setup* to start the Wizard.



## COMPONENT DEFINITION

The first page shown by the Wizard is the *Component Definition*.

Click on the *Material* field to open the drop-down menu. Select the material of the tube to be inspected. If the material is not in the list, you can click on *Manage...* to open the *List of Available Material* window.

**New Setup Wizard** ×

**Component Definition** █

Configure the geometry and material of the component to inspect

Geometry:  Surface  Tube from ID

Application:  Generic  Air Conditioner

Material:

Resistivity: 74  $\mu\Omega\cdot\text{cm}$

Permeability: 1  $\mu$

Velocity: 5660.000 m/s

Wall thickness:

BWG

Outside diameter:

Length:

Note about selected material:

Application: Austenitic alloy-steel boiler, superheater, and heat-exchanger tubes.  
Composition: ~17% Cr, ~12% Ni, 2% Mo, Fe remaining  
UNS: S31600  
ASTM: A213 TP316, A249 TP316, A688 TP316

To add a new material to the list, click on *Add*. A new line will appear in the list. Give the material a relevant name and set the material resistivity and permeability to its theoretical value. The resistivity and permeability are used to set electro-magnetic techniques parameters only. They don't need to be set if an electro-magnetic inspection is not performed on this material.

It's possible to add a note about the material to specify information such as its application or composition. When you are done, click *OK*.

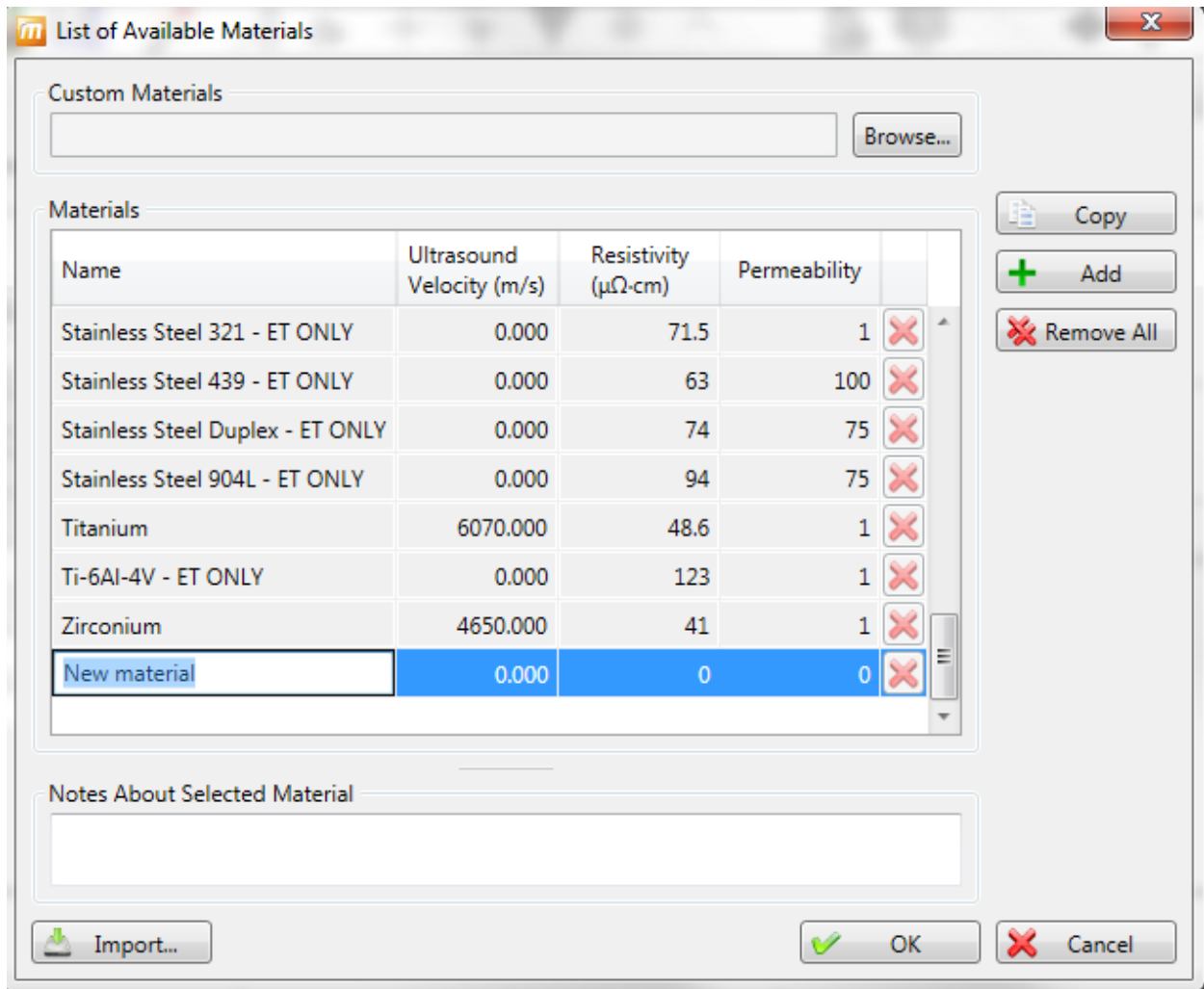

You will be back to the *Component Definition* window. If you added a new material, it will now be available in the material list.

Adjust the tube wall thickness by entering the value in the *Wall thickness* field or by moving the slider. Enter the tube's outer diameter and length.

These tube properties will help Magnifi to suggest the optimal scan parameters.

Click *Next* when everything is set correctly.

## PROBE SELECTION

New Setup Wizard

### Probe Selection

Select the probe that you want to use for your inspection

Technique: IRIS

**Recommended**

Accessories	Eddyfi Part Number	Description
Turbine	IRIS-TB-170	
Transducer	IRIS-TD-20M-318	
Centering Device	PRBT-IRIS-CDSM-SLA	

**Selection for setup creation**

Turbine:  8.5 mm (Eddyfi)  12 mm (Eddyfi)  17 mm (Eddyfi)  Other

Transducer frequency:  5 Mhz  10 Mhz  15 Mhz  20 Mhz

Cancel Back Next

By selecting the Iris technique, Magnifi will recommend a Turbine, Transducer and Centering Device to be used for the optimal results for the tube in the previous section. In the case you don't have the transducer in hand and you don't have time to order it, we suggest using the closest possible frequency and a focal a bit further than the recommended transducer. Click *Next* when you're finished.

## SCAN DEFINITION

The screenshot shows a software window titled "New Setup Wizard" with a close button (X) in the top right corner. The main title is "Scan Definition" with a green progress bar. Below the title is a gear icon and the instruction "Configure the type of scan you will be performing with your probe". The main area contains the following settings:

Scan:	Rotating
Main Scan Axis:	Y Axis
Position from:	Trigger
Acquisition rate:	16009 Hz
Typical probe speed:	80.0000 rps

At the bottom right, there are three buttons: "Cancel" (with a red X icon), "Back" (with a left arrow icon), and "Next" (with a right arrow icon and a dashed border).

The *position from:* option defines how the c-scan is populated. It can be populated by using the pin at the end of the turbine or using an encoder. The Acquisition rate can be increased after the setup by clicking on Scan icon from the *Setup* menu. Increasing the Acquisition rate will enable you to rotate faster, but the inspection can possibly become noisier. Click *Next* when you're finished.

New Setup Wizard

### Scan Definition

Encoder and axis settings

Rotation Axis	Axial Axis
Offset: 0.000 °	Offset: 0.000 mm
Displayed Resolution: 2.000 °/smpl	Displayed Resolution: 1.000 mm/smpl
Size: 360.0 °	Size: 5080.0 mm

Cancel Back Next

The resolution is set to have 180 points through the circumference and have 1 point every mm on the tube axis. Click *Next* when you're finished.

## INDICATION CODES

The *Indication Codes* page is used to define the entries that can be added to the report when analyzing the data.

Code	Description	Type	Automatic	Color	
COR	Corrosion	Defect			X
CRK	Crack	Defect			X
DNT	Dent	Defect			X
DSI	Distorted support indicatic	Defect			X
ERO	Erosion	Defect			X
NDD	No defect detected	No indication			X
OBS	Obstructed	Feature		Red	X
PIT	Pitting	Defect			X
PLG	Plugged	Feature		Brown	X
RST	Restricted	Feature		Yellow	X
WLL	Wall loss long	Defect			X
WLS	Wall loss short	Defect			X
WLT	Wall loss taper	Defect			X

When an indication is added, its abbreviation (code) is shown in the code pane, next to the data.

You can modify the default indications codes list by changing the parameter in the table. New indications can be defined by clicking on the *Add* button.

Click *Next* when you are done

## DISPLAY

The second *Display* window is used to set the layouts. Checking the tick boxes in this window will make the proposed layouts available in your setup. You will be able to switch from one to the another via the layout tab.

The layout with the blue background will be the one opened by default, which can be changed to your desired option.

Layouts can be readjusted at any time.

New Setup Wizard

**Display**

Select the layout that you want to use to display your inspection results

1 C-scan, 3 Projections		
<input checked="" type="checkbox"/>	CS	BS
	DS	Cy
AC		

2 C-scans, 2 Projections		
<input type="checkbox"/>	CS	BS
	CS	Cy
AC		

1 C-scan, 2 Projections, 1 Info		
<input type="checkbox"/>	CS	BS
	DS	I
AC		

2 C-scans, 1 Projection, 1 Info		
<input type="checkbox"/>	CS	BS
	CS	I
AC		

: Default layout

Help Cancel Back Finish

Click *Next* to complete the setup wizard process.

## DATA LIST

---

Magnifi will create a file for each inspected tube. The list of tubes can be created in the *Data List* section of the *General* tab of the *Backstage*.

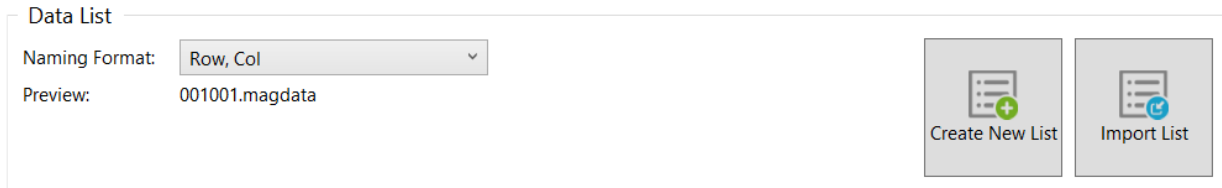

The screenshot shows a software interface for creating a data list. It features a 'Data List' section with a 'Naming Format' dropdown menu currently set to 'Row, Col'. Below this, a 'Preview' field shows the resulting filename '001001.magdata'. To the right of these fields are two buttons: 'Create New List' (with a plus icon) and 'Import List' (with a document icon).

Four options are available to set the filename format:

- 1. Free format:**  
Each file has a custom name. Can also be defined from the Data tab of the Front Stage.
- 2. Prefix:**  
The file name includes a defined prefix followed by a sequential number.
- 3. Row, Col:**  
Row number, Column number. Mostly used for tubing inspections.
- 4. Zone, Row, Col:**  
Zone number, Row number, Column number. Mostly used for tubing inspections.

Click on the *Create New List* button. The displayed window will be different depending on the chosen filename format.

For the *Row, Col* option, enter the number of rows, the starting row number and row interval. You can then enter the number of tubes per row in the *Nb. of Columns* fields of the table. Click on *Create* to generate the list of tubes. You can also use the *Create & New* button to add another set of tubes to you list.



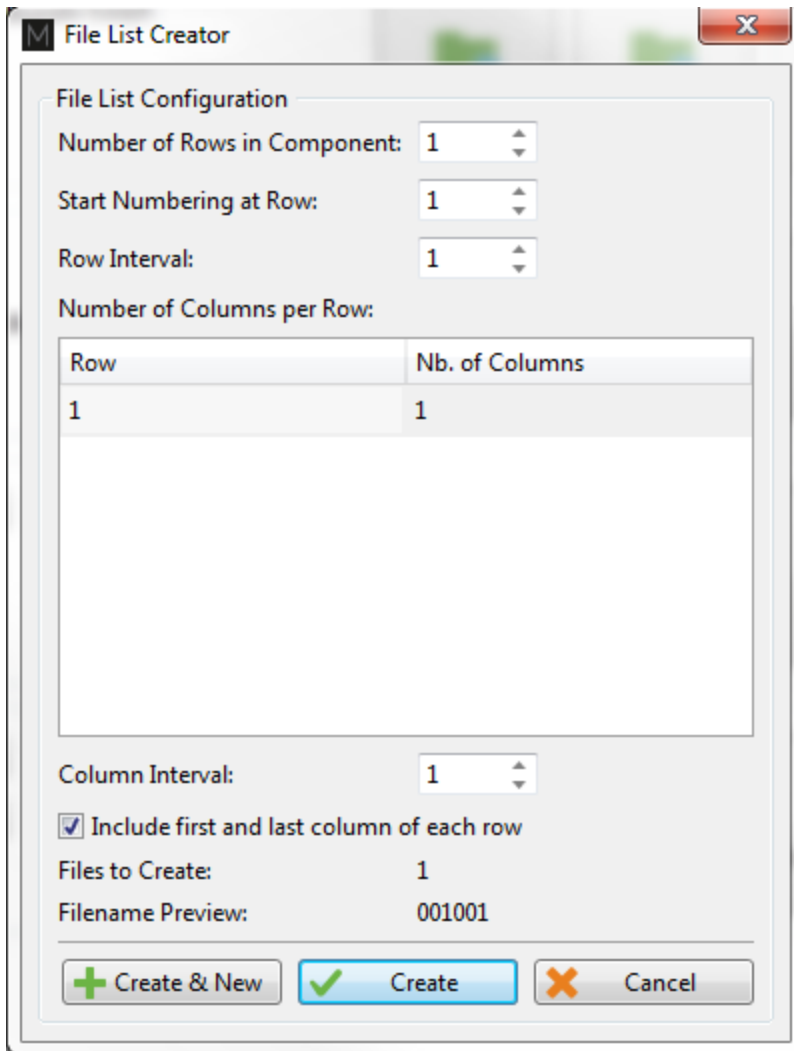

The same principles apply to the other file formats, except for the *Free format* option for which the file name(s) needs to be entered manually in the file name window of the Frontstage. The tube list can also be imported from another project using the *Import List* button. The tube list file can be found in the Inspection folder. It is also possible to import a list created in Tubepro.

## HARDWARE ASSEMBLY

---

Note: Please report to the relevant supplied document if you use a micro turbine and extra-small centering devices.

Unscrew the turbine base from the turbine.



Holding the centering device, screw the turbine base

- Make sure the arms do not come in conflict with the turbine base.
- To optimize your probe data, both centering modules must be far from each other and the centering arms must be in the direction showed on the picture below:



Insert the microdot connector at the base of the centering device until it exits the base of the turbine previously assembled



Screw the poly to the base of the centering device

- Make sure the IRIS coaxial cable at the far end and close to the microdot connector is not kinked. You may have higher noise just after the front wall echo in the A-scan. It will directly affect the probe sensitivity on smaller defects.



Screw the transducer to the microdot connector

- If your transducer has white spots on the curved section, this is an indicator to eventually replace it. To increase its lifetime, don't use it without coupling (water) and remove the BNC connector when the probe is not running.



Screw the turbine to its base

- The UT transducer must not push the turbine rotor. To avoid it, shake the IRIS cable until the UT transducer is completely inserted in the turbine.
- Make sure the rotation is smooth. If not, you may have to lubricate the rotor. It may also be necessary to clean the mirror for better signal quality.
- Centering tape can be added to the turbine.



Connect the BNC cable to the BNC connector on the poly



Connect the BNC cable to the Ectane



## TIPS

- To optimize your probe data, both centering devices must be far away from each other and in the right direction, as in the picture below.
- Centering tape can also be added to the turbine.
- Make sure the UT transducer doesn't push the turbine rotor. To avoid this situation, shake the IRIS cable until the UT transducer is completely inserted in the turbine
- With the XS centering devices, use the key to adjust both centering modules at the proper strength.



## PERFORMING AN ACQUISITION

1. If you are in the Backstage, move to the Frontstage by clicking on the *Start/Resume* button.
2. Click on the *Connect* button under the *Instrument* tab. This will open the *Instrument configuration* page. Click on the line showing the instrument to which you want to connect and then click *Connect*.

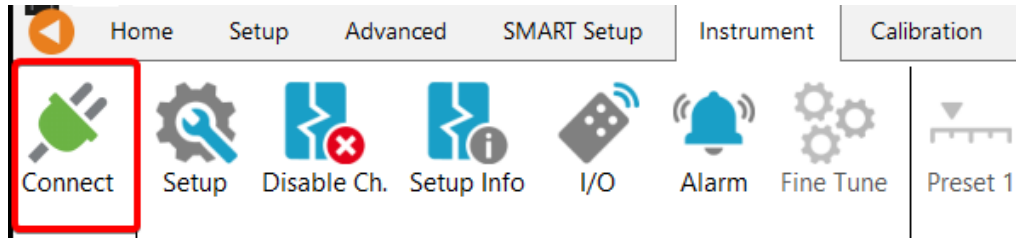

Note: Your Ectane firmware version may not match the version of Magnifi you are using. If this is the case, a red and white X icon will be shown in the *Status* field of the *Instrument connection* window. To download a matching version to your Ectane, click on the *Config.* button and then click the *Send firmware to the instrument* button of the *Instrument configuration* window.

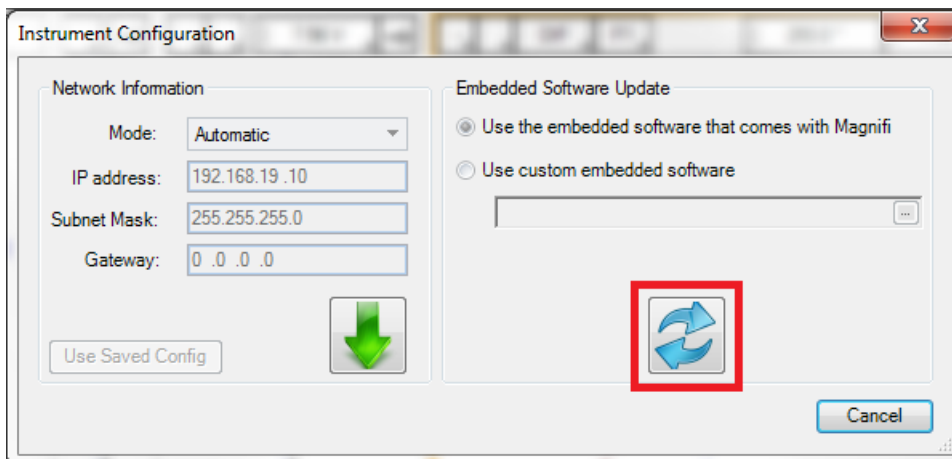
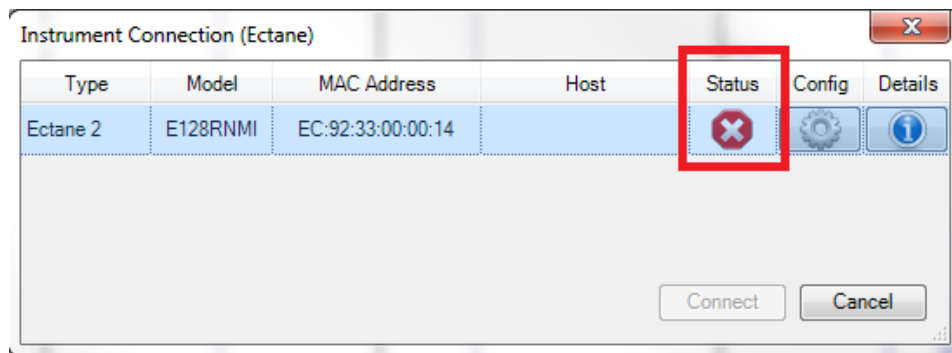

Two (2) acquisition modes are available in Magnifi: *Setup Mode* and *Acquisition Mode*. *Setup Mode* is used to scan your calibration tube and make the necessary adjustments on your setup without saving the data automatically. *Acquisition mode* is used for the inspection - in this mode, the software automatically saves the acquired data using file names based on the tube list.

- For the gates adjustment, go to *Setup Mode* by clicking on the *Setup Mode* button under the *Home* tab. This mode is active when the *Setup Mode* button is grayed.

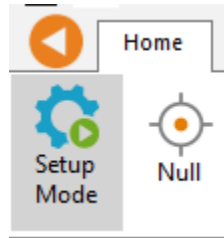

- Push the centering device fully in the tube and make sure the ultrasonic beam is in a clear area in your standard.

- Click *Start/Resume* to start the acquisition.

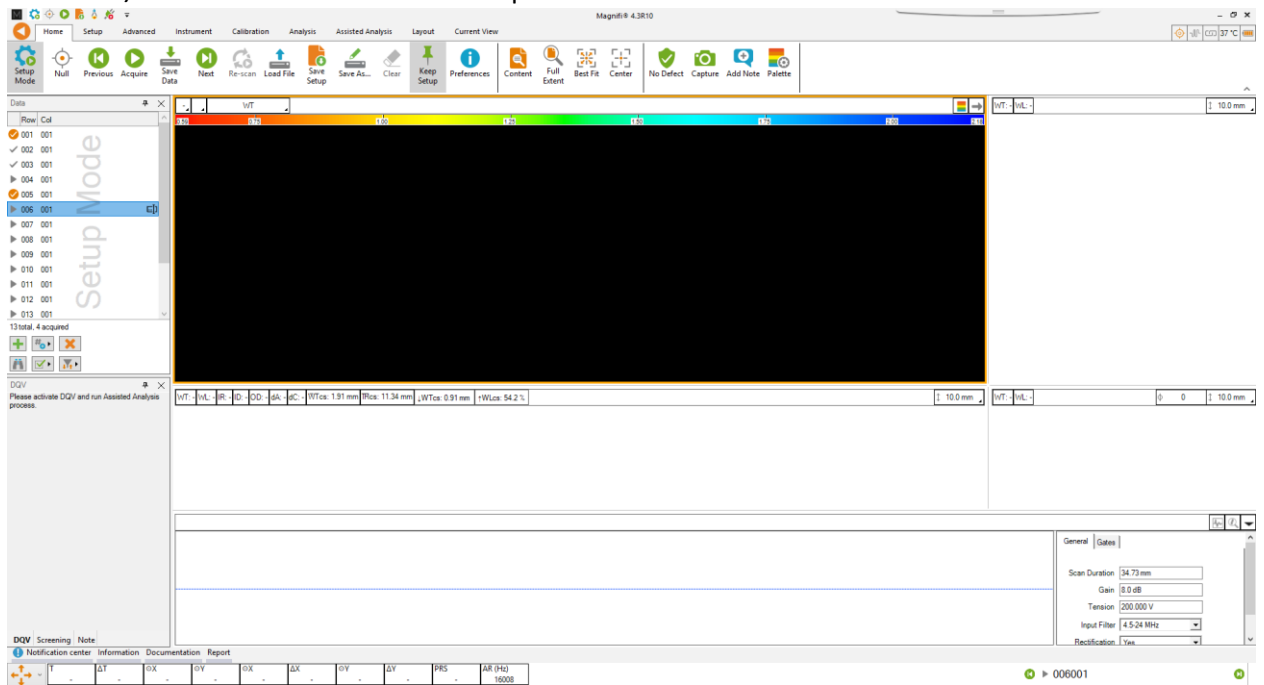

## 6. Increase the size of the A-scan window

The screenshot shows the software interface with the A-scan window expanded. The window title is "WT" and it displays a color-coded A-scan plot. The parameters shown are: WT: 1.91 mm, IR: 11.34 mm, ID: 0.91 mm, and WL: 54.2%. The interface includes a menu bar with options like Home, Setup, Advanced, Instrument, Calibration, Analysis, Assisted Analysis, Layout, and Current View. A toolbar contains various icons for file operations and analysis. On the left, there is a "Setup Mode" sidebar with a list of items (001-013) and a "13 total, 4 acquired" status. At the bottom, there is a "DQV Screening Note" section and a notification center.

## 7. Start the IRIS pump and press F2 to see live data.

The screenshot shows the software interface with live data displayed. The A-scan window title is "WT" and shows a color-coded plot with a yellow area on the left. The parameters are: WT: 1.05 mm, VL: 47.1%, IR: 11.62 mm, ID: 23.62 mm, CD: 25.71 mm, and WL: 54.2%. The interface includes a menu bar, toolbar, and various panels. On the left, there is a "Setup Mode" sidebar with a list of items (001-013) and a "13 total, 4 acquired" status. At the bottom, there is a "DQV Screening Note" section and a notification center. The bottom status bar shows: Pos Y (mm) 19.38, Scale (mm) 500.0, PRS (rpm) 0.0, AR (Hz) 55.1, and AR (Hz) 16008.

8. Press  to get an envelope over your A-Scan

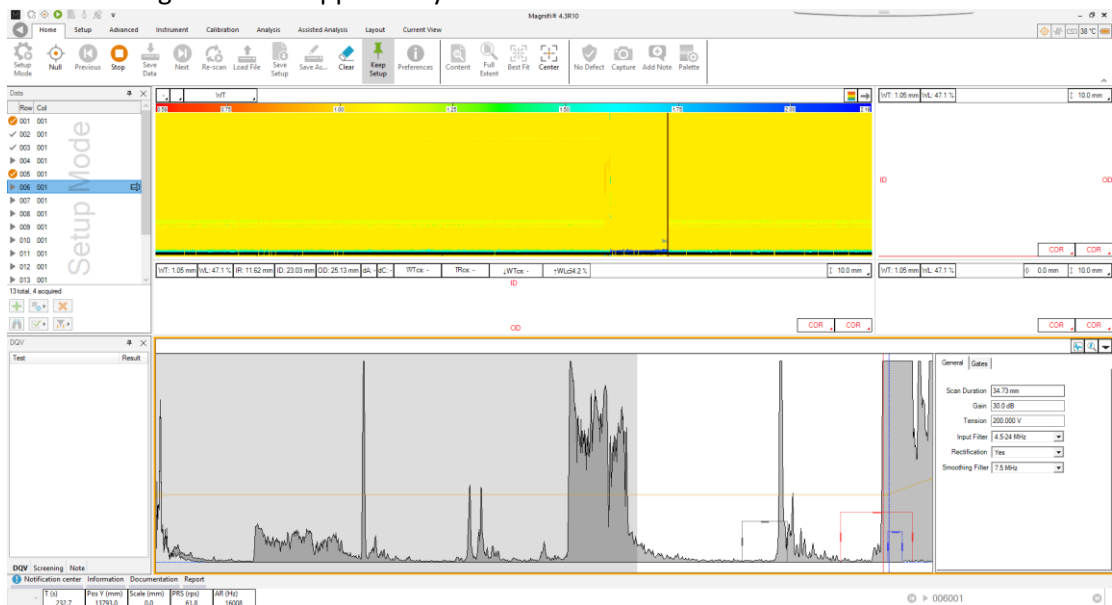

9. Set the start position and the length of the pin gate as narrowly as possible. The level should be set to avoid the surrounding noise level. (This is to make sure no noise will come in the gate and increase the rotation speed.)

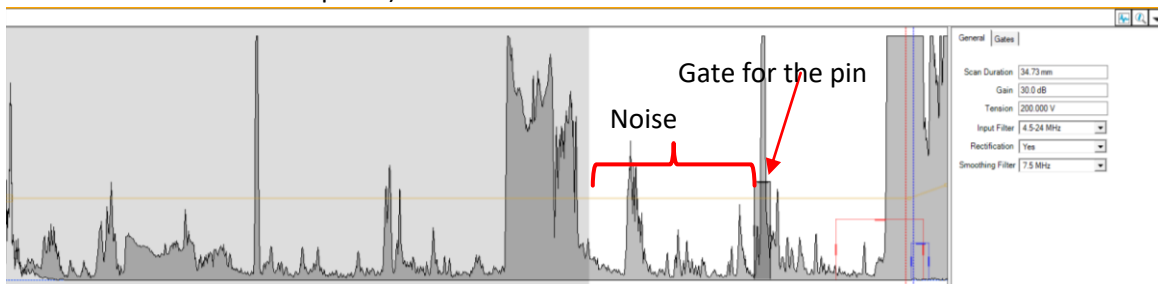

10. In this situation, reducing the overall gain will reduce the noise level. After the gain is adjusted, click two times on  to refresh the A-scan.

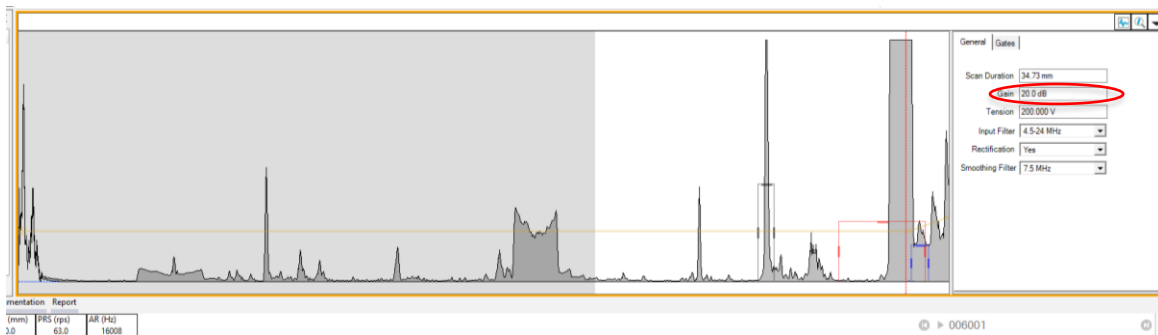



11. Adjust the front wall gate, it needs to be as low as possible without catching noise and wide enough to get the movement of the front wall due to the centering.

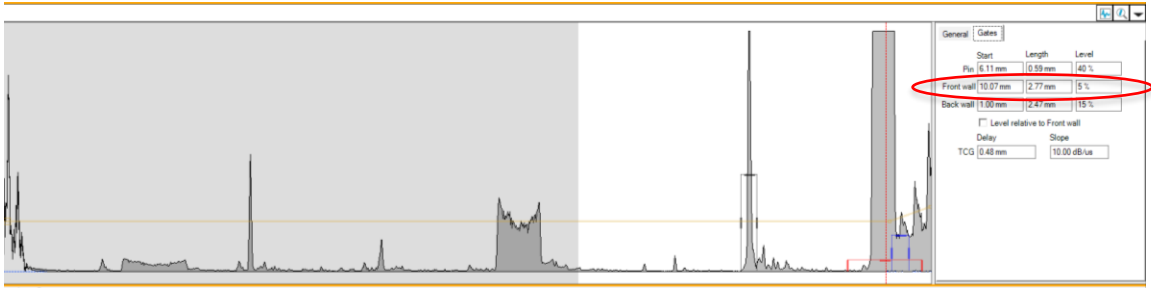

12. Click on to remove the envelope and click on to zoom on the back wall.

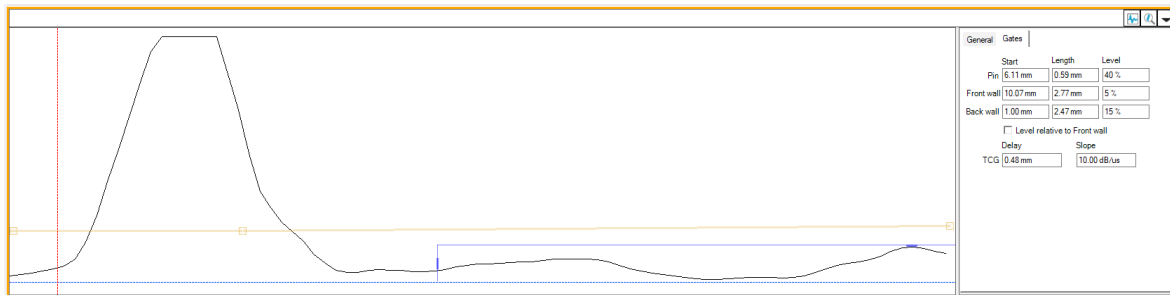

13. Increase the TCG slope as much as possible without putting too much noise in the signal. The backwall signal should be around 80% of the full screen height.

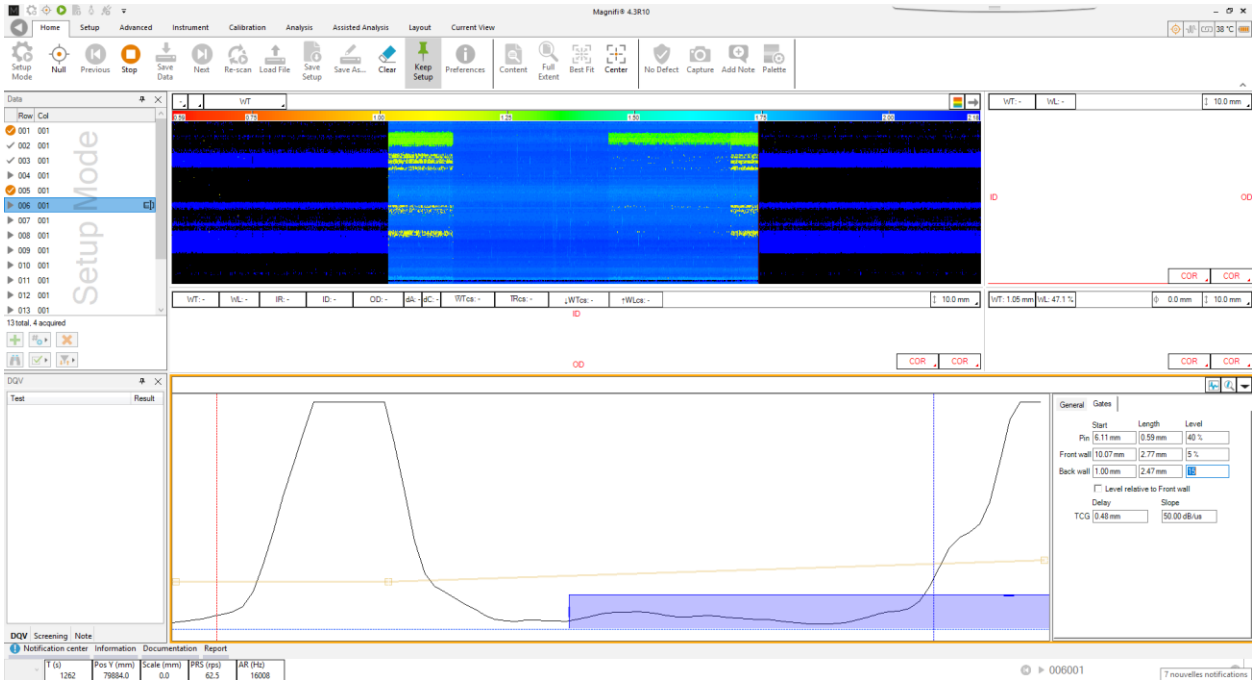

14. Increase the Level and the Start position of the back wall gate to clean the C-scan and bring the gate as close as possible to the front wall.

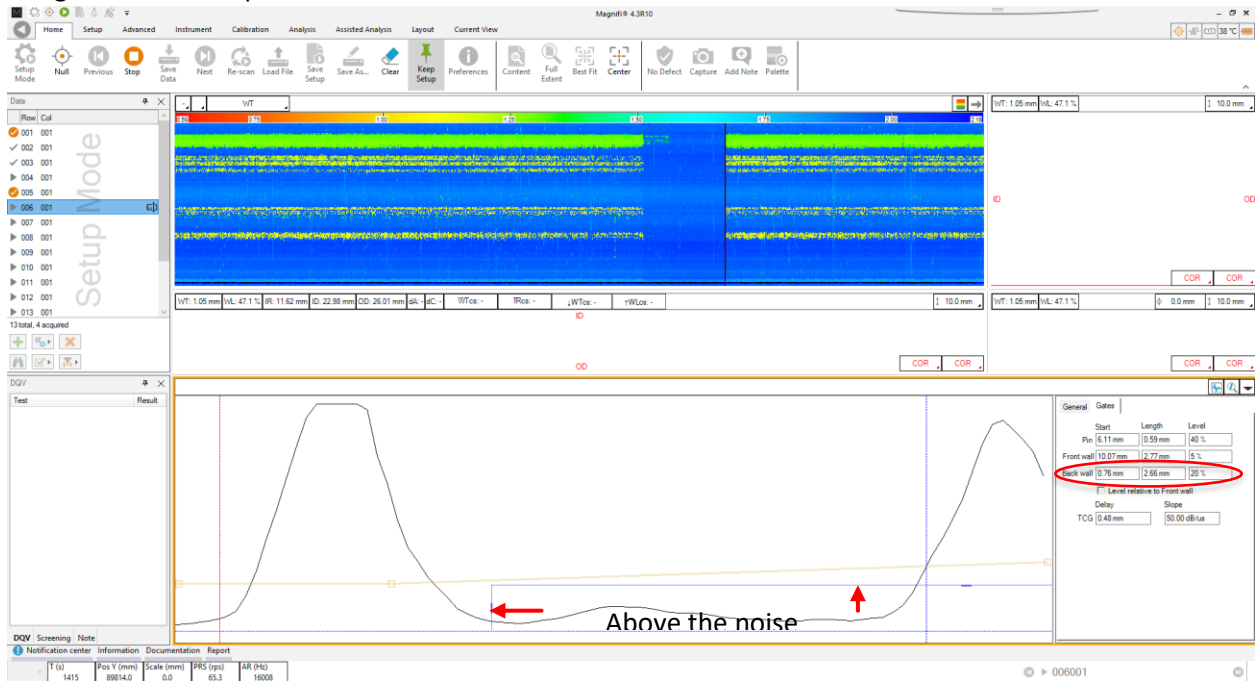

Press F2 to stop the acquisition, press F2 again start the acquisition and pull your calibration tube. The pulling speed should be around 50 to 100mm/s

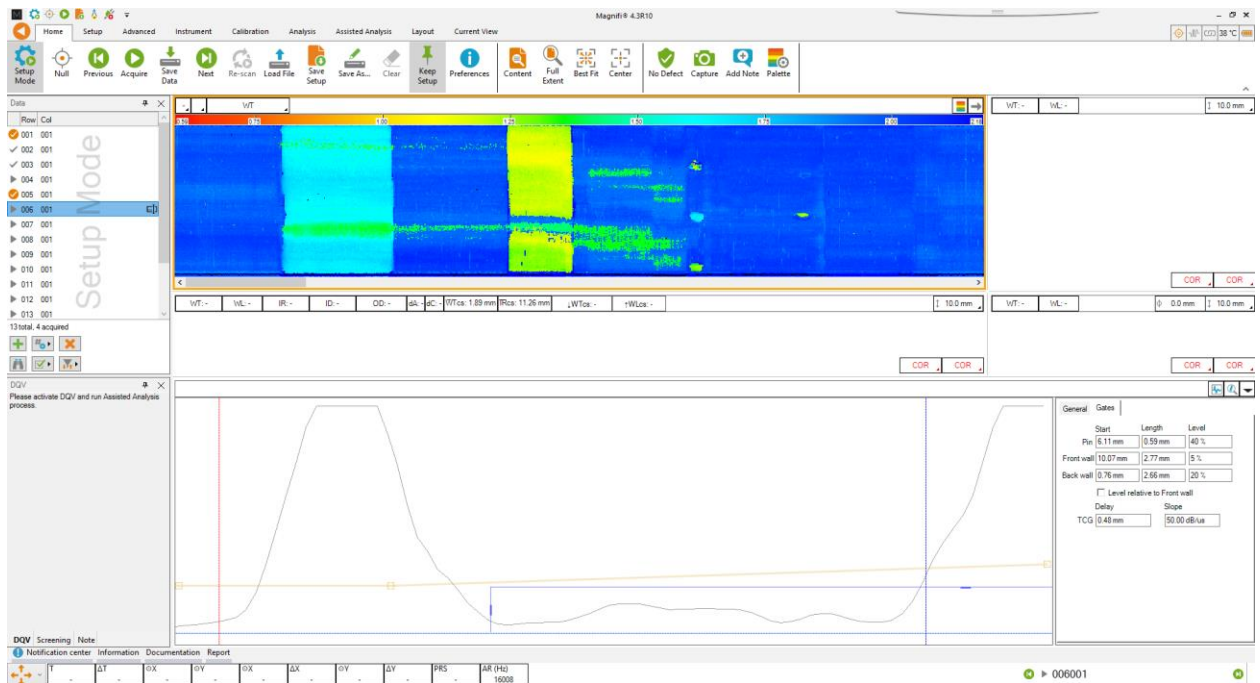

15. To troubleshoot this kind of result (green noise in the C-Scan), different options are available. (Do the changes while you are acquiring the data to see the results live)
  - a. Reduce overall gain in the general tap.
  - b. Increase the level of the backwall gate.

In the image below the probe is on the 50% OD groove (the last part of the C-scan in yellow).

- c. You need to reduce the level of the backwall gate.
- d. You might need to decrease the overall gain again and increase the slope of the TCG to clean the C-Scan

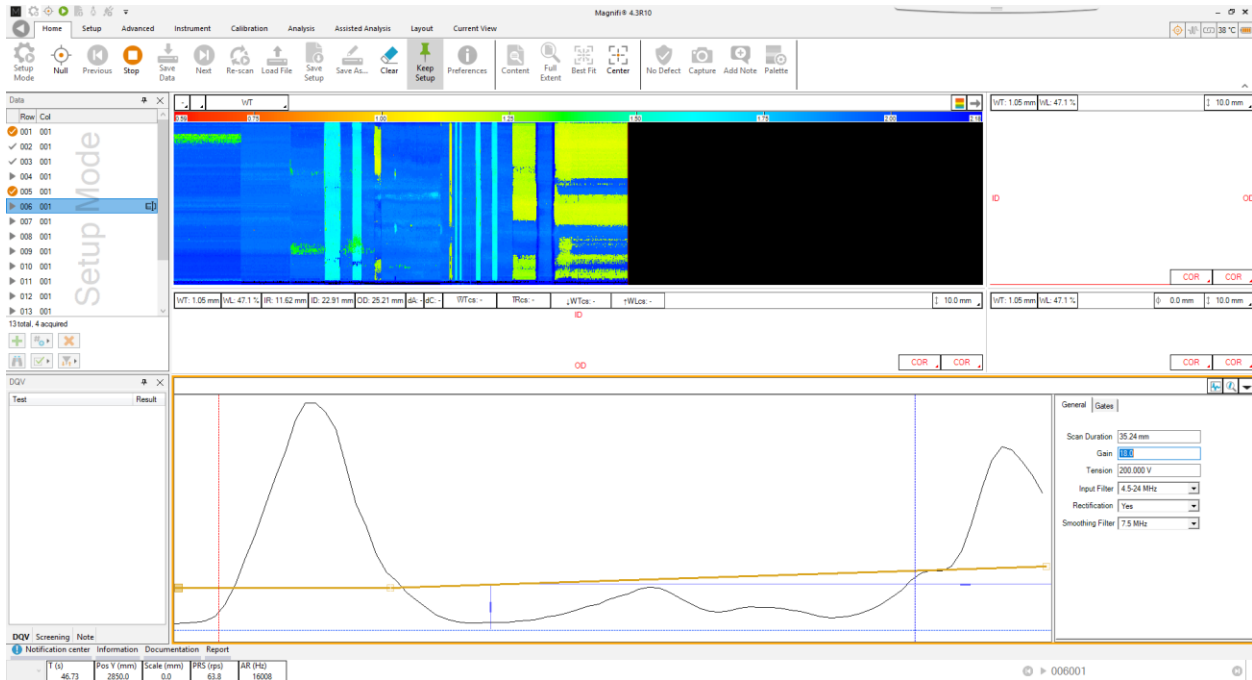

16. Put the cursor into a clear portion of the tube. Click on , select Probe Delay and Wall Thickness and then press Calibrate. (That will adjust the velocity and wedge delay to get the defined WT in your readings)

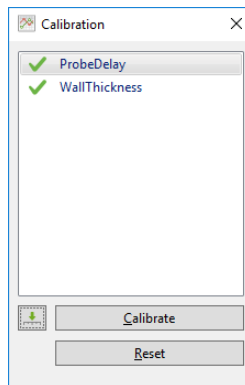
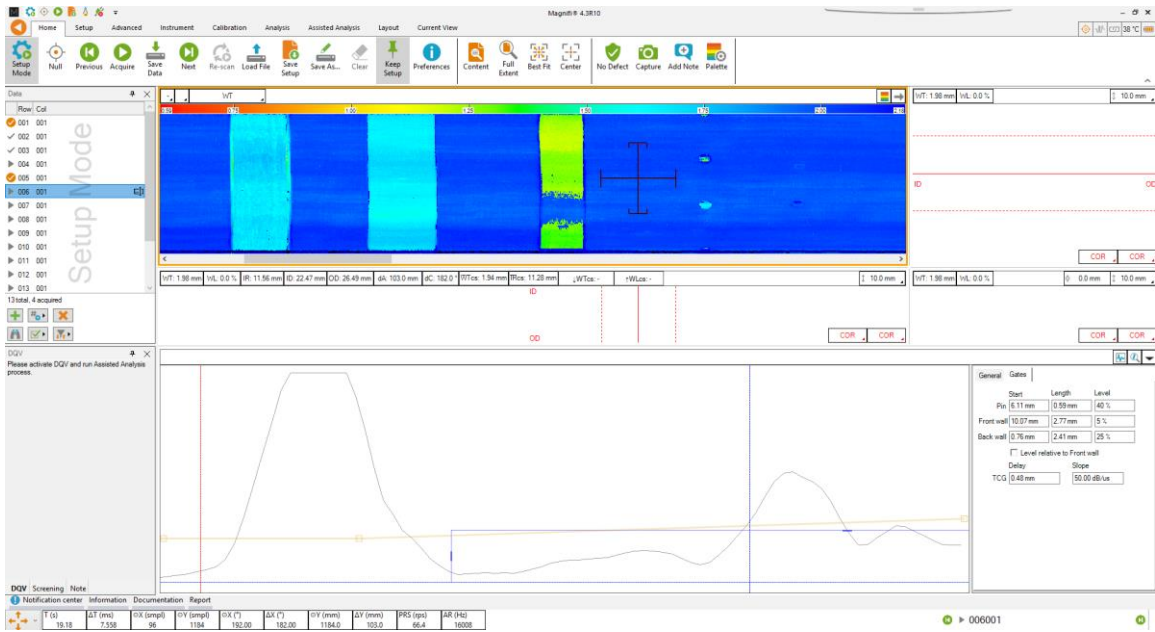

17. Play with the color palette to improve the image.

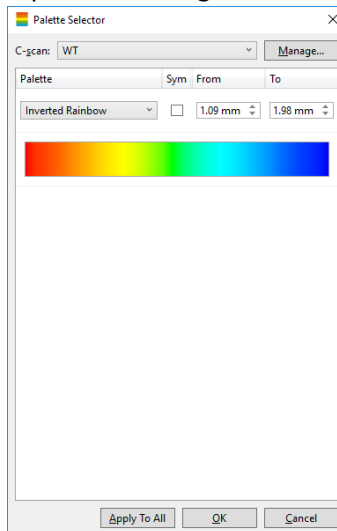

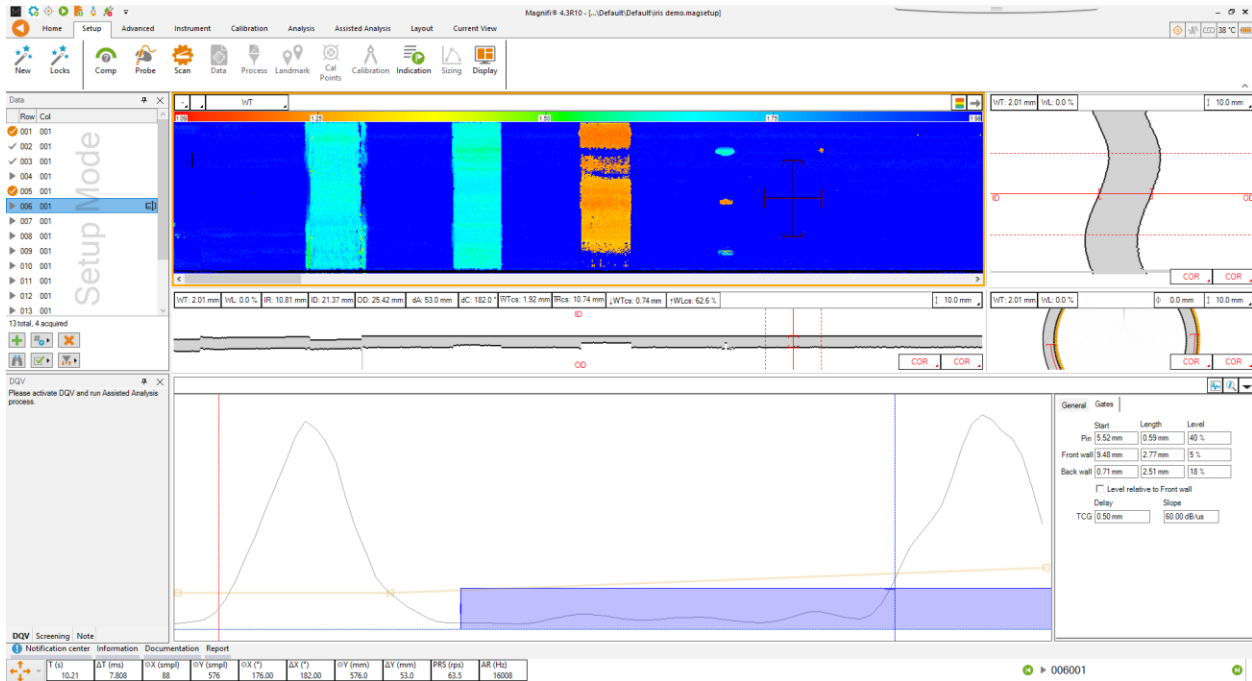

Note: In this presentation, we used a shorter focal length (1in) for the transducer. So, it reduces the Back Wall response. That's why the 50% groove (3<sup>rd</sup> groove) is not clean. The level of the OD signal of the 50% groove is sometimes at the same level as the base noise.

## SAVING YOUR SETUP

Once all your setup adjustments are done, you can save your setup by clicking on the *Save Setup* button under the *Home* tab. The displayed window will allow you to give an appropriate name to your setup and to save it at the desired locations. The save location is, by default, your inspection file. Note that when a data is saved, the setup is also saved with it.

You can also save the data of your calibration standard by clicking on the *Save As* button under the *Home* tab.

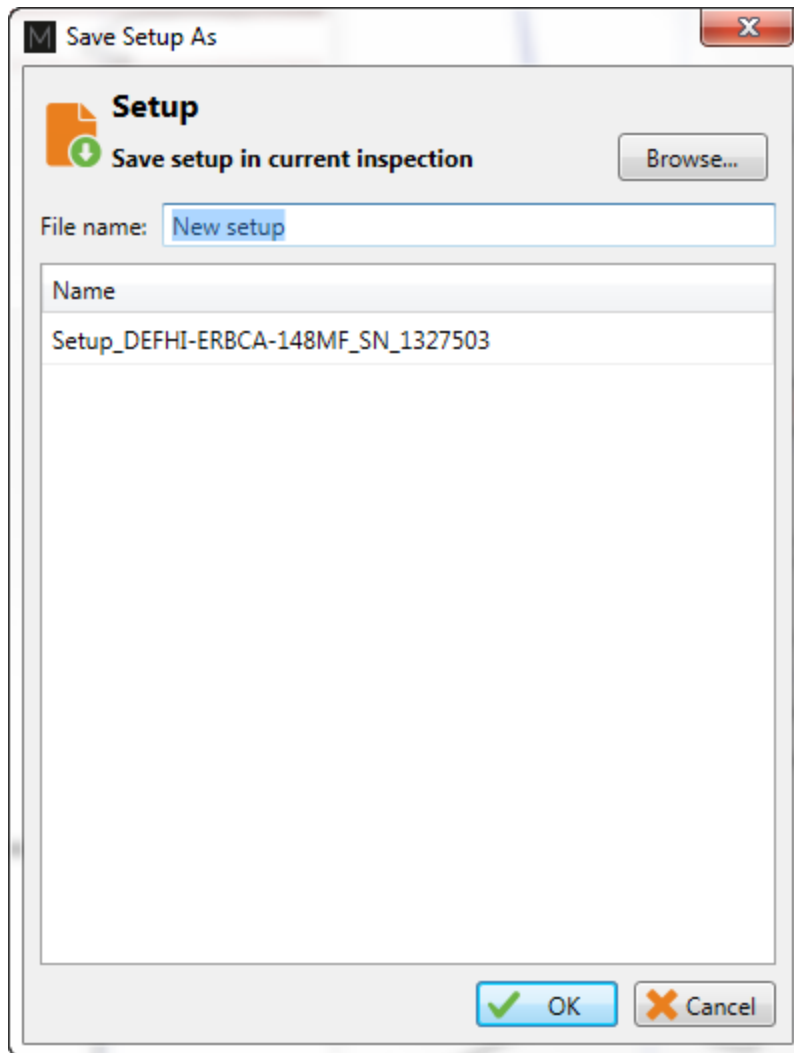

## DATA LIST MANAGEMENT

For each acquisition, Magnifi can automatically save a file using the file name defined previously in the *Tube list* section of this document. To do so, checkmark the *Automatic File Recording* option that can be found under the *General tab* of the *Preference* menu of the *Backstage*.

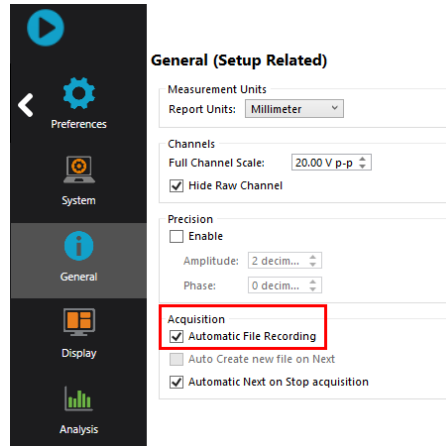

The list of tubes is also shown in the *Data* window.

Row	Col	Scan Count
✓	101000001	20
✓	101000002	9
✓	101000003	10
✓	101001001	16
✓	101001002	9
✓	101002001	11
✓	101002010	14
✓	101004005	5

A common practice is to rescan your calibration tube and balance the probe periodically. You can save this new calibration tube data by adding a new tube in your tube list (999 001 for example). Or you can go out of the acquisition mode, scan your tube, and click on the *Save Cal As...* button under the *Calibration* tab to save your data. You can then go back to the *acquisition mode* to continue your inspection and to automatically save the acquired tubes in your bundle.

Once a tube has been scanned, the " play " icon will be replaced by a checkmark icon next to the tube description.

You can rescan a tube by selecting its name in the list and by clicking on the *Rescan* button in the *Home* tab.

Also, a tube name can be changed by right-clicking on its name and by selecting the *Rename* option.

## INSPECTION

The following section describes how to perform an inspection.

1. Go to the *Acquisition Mode* by clicking on the *Setup Mode* button under the *Home* tab. The *Acquisition Mode* is activated when the *Setup Mode* button is not grayed.
2. Insert the centering device/turbine into the tube to inspect, start the IRIS pump and start the acquisition by clicking on the *Acquire* button under the *Home* tab or by pressing the F2 on your keyboard.
3. Pull the probe at approximately 2"/s (50 mm/s).
4. When it's done, press the *Stop* button or again F2 on your keyboard.
5. Repeat steps 2,3 and 4 for all the tubes to inspect in your bundle.

For each acquisition taken, Magnifi can automatically save a file using the file name defined previously in the *Tube list* section of this document. To do so, checkmark the *Automatic File Recording* option that can be found by clicking on the *Acquisition preferences* button in the *Data* window. This option is selected by default.

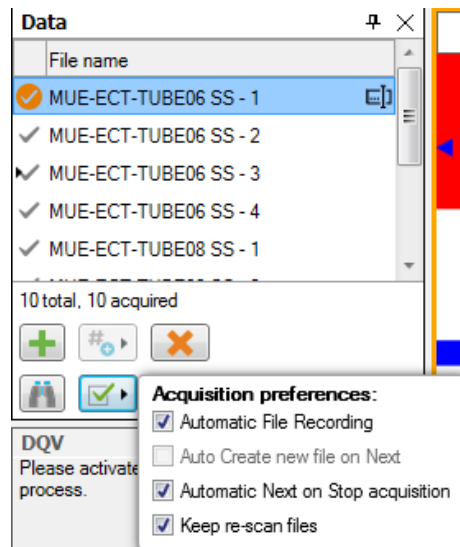

The list of tubes is shown in the *Data* window on the left of the Frontstage.

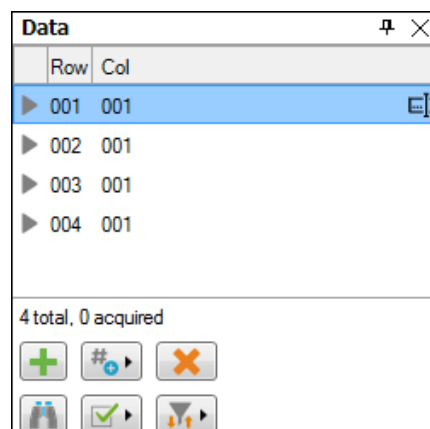



Tubes can be added or removed by using the first line of buttons of this window.

Once a tube has been scanned, the " play " icon will be replaced by a checkmark icon next to the tube description.

You can rescan a tube by selecting a tube in the list and by clicking on the *Rescan* button in the *Home* tab.

Also, a tube name can be changed by right-clicking on a tube in the list and by selecting the *Rename* option.

## LOADING A FILE

6. First disconnect your computer from the Ectane by clicking on the *Disconnect* button under the *Home* tab
7. You can load a file by double-clicking on the file name in the *Data* window. It can also be done by selecting the file in the list and by clicking on the *Load* button under the *Home* tab. Note that double-clicking on a tube when you are still connected to an instrument will initiate data acquisition.
8. You can open the next or the previous file in the list by clicking on the *Previous* or *Next* button of the *Home* tab.

The data files can be filtered by using the *Filter* button of the *Data* window.

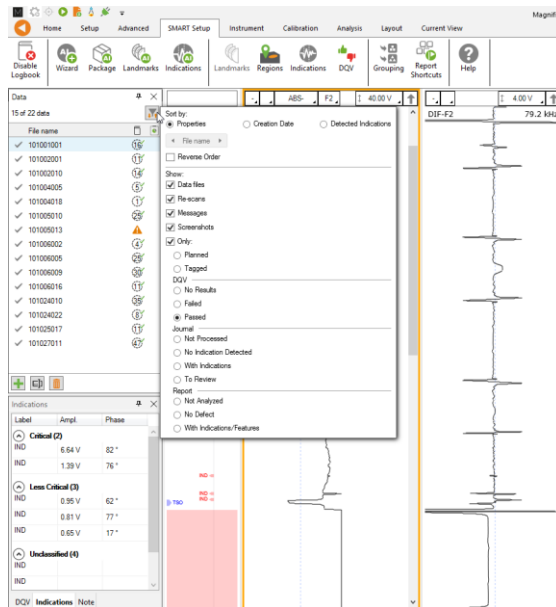

## REPORT

### INDICATIONS

The two *Indication* buttons at the lower corner of the Lissajous windows can be used to add an entry to the report. These two buttons indicate the code that is associated with the defect being entered. Both buttons are identical, but can be set to identify different flaws.

To add an indication to the data:

1. Select the indication in the C-scan and adjust the cursor so that the cursor only includes the indication
2. Then, click on the red triangle in the corner of the *Indication* button to select the type of defect to enter.
3. Click on the defect button to add an entry to the report.

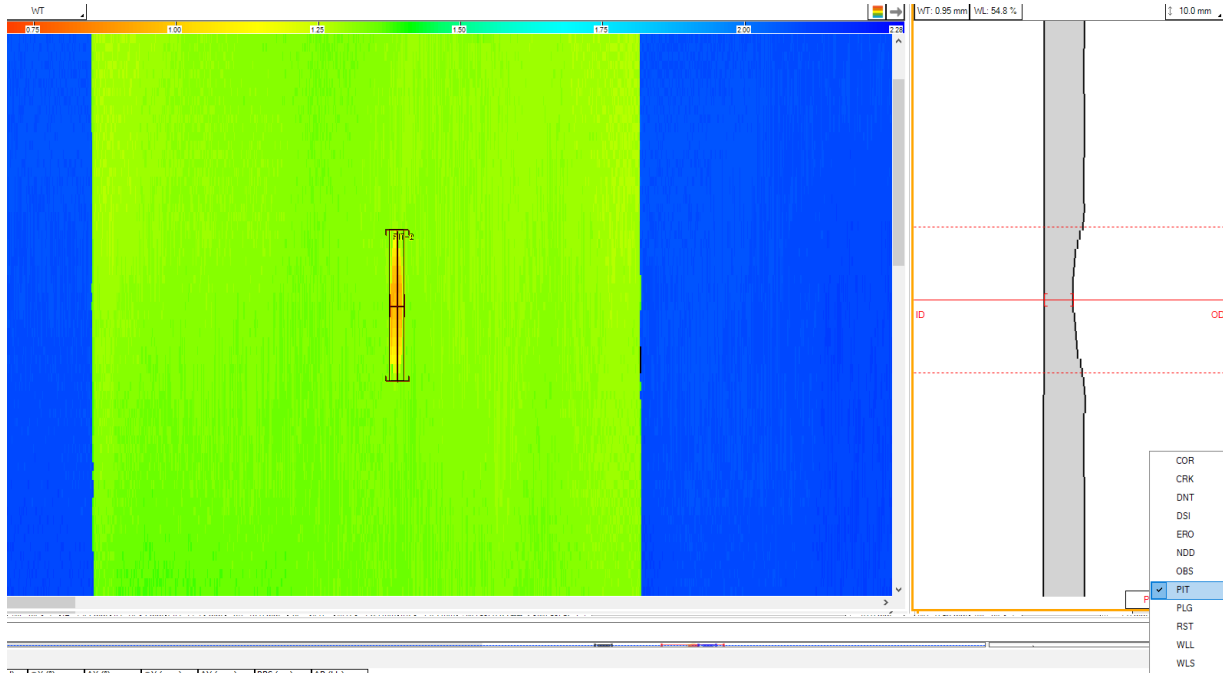

Indications can also be added to a tube to indicate, for instance, that it has no flaw or that it is plugged.

To add an indication to a tube:

1. Load the file
2. Click on the appropriate indication button available under the Analysis tab

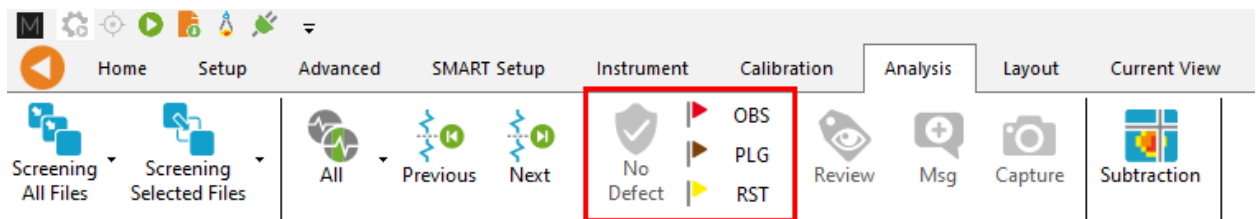

## REPORT TABLE

To access the list of indications entered:

1. Make sure that the Report option is selected under the Layout tab.

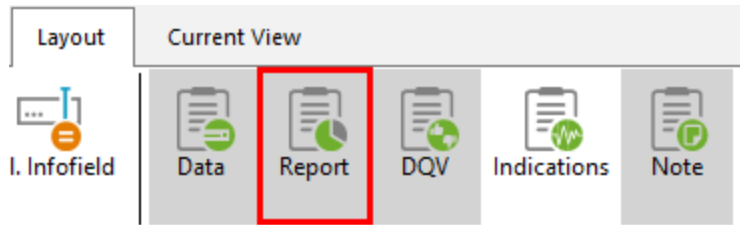

2. Click on the report ribbon at the bottom of the screen to make the list visible

Report														
	Zone	Row	Col.	Code	Size	Side	WT (mm)	Channel/C-scan	Y pos. (mm)	Y leng. (mm)	X pos. (°)	X leng. (°)	Comment	
1	EU	27	790	PIT	54.76	o	0.95	IRIS	1029.0	15.0	276.00	34.00		X

Information Documentation Report

Entries in the report can be modified by changing the value in the table. You can also delete an entry by clicking on the X next to it.

## REPORT GENERATION

Magnifi can automatically generate a full report with the report table.

To generate this report:

1. Go to the *Backstage* by clicking on the arrow at the upper left corner of the *Frontstage*.
2. Click on the Generate Report button under the *Report* section of the *General* tab.
3. Choose your preferences and enter the required parameters. The *# of tube in component* is used to show the percentage of tube in each category.

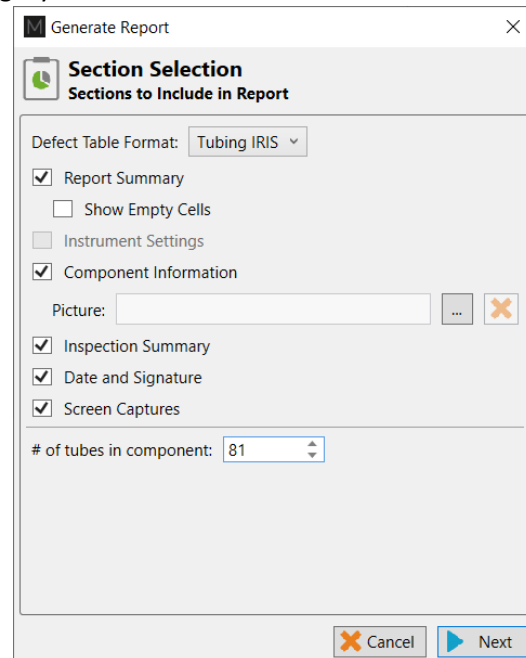
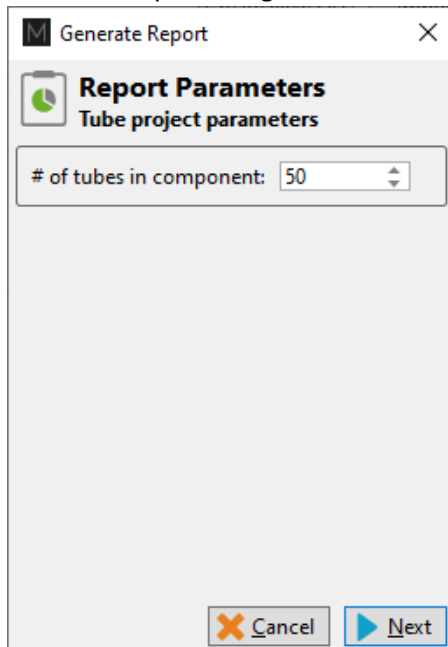

4. Click Finish to generate the report.

Once generated, the report is saved as a .html file in the current Inspection sub-directory. It can be viewed using any regular web browser.

There is a “copy” button next to each element of the report such as tables and images. When clicking on it, the element will be copied to the clipboard. It can then be pasted to another file such as an Excel or Word.

**Analysis Report**

Instrument Settings

Setup name: ECT-Bobbin

**Channels**

Name	Frequency (KHz)	Drive (V)	Gain (dB)	Low Pass (KHz)	High Pass (Cnt)
R_ABS-F1	160.0	2.50	46.0	400	
R_ABS-F2	80.0	2.50	46.0	400	
R_ABS-F3	40.0	2.50	46.0	400	
R_ABS-F4	20.0	2.50	46.0	400	
R_DIF-F1	160.0	2.50	46.0	400	
R_DIF-F2	80.0	2.50	46.0	400	
R_DIF-F3	40.0	2.50	46.0	400	
R_DIF-F4	20.0	2.50	46.0	400	

The Print button, bottom right corner on image above, can be used to either print a paper copy of the whole report or to save it as a .pdf document. The PDF generator available with the current web browser will be used.

10/10/2023 10:31 Magnifi Report

**Analysis Report**

Instrument Settings

Setup name: ECT-bobbin

**Channels**

Name	Frequency (KHz)	Drive (V)	Gain (dB)	Low Pass (KHz)	High Pass (Cnt)
R_ABS-F1	160.0	2.50	46.0	400	
R_ABS-F2	80.0	2.50	46.0	400	
R_ABS-F3	40.0	2.50	46.0	400	
R_ABS-F4	20.0	2.50	46.0	400	
R_DIF-F1	160.0	2.50	46.0	400	
R_DIF-F2	80.0	2.50	46.0	400	
R_DIF-F3	40.0	2.50	46.0	400	
R_DIF-F4	20.0	2.50	46.0	400	

Imprimer 4 pages

Destination Enregistrer au format i

Pages Tous

Mise en page Portrait

Plus de paramètres

Enregistrer Annuler

The report logo can be modified by clicking on the *Select Company Logo* that can be found under the *System* tab of the *Backstage*.

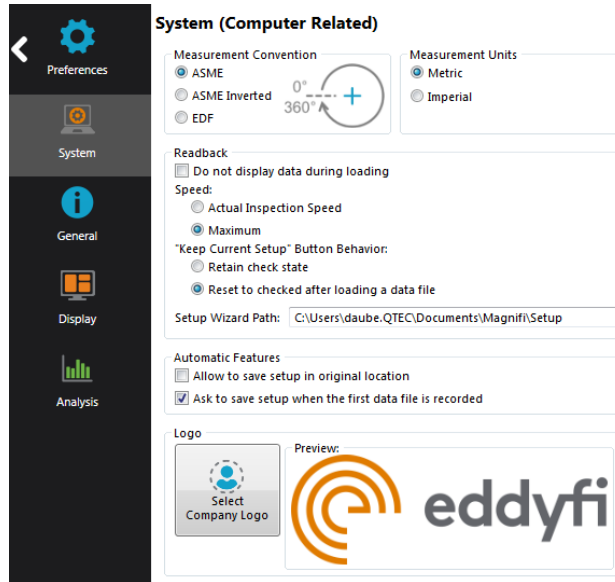

The report table file in the *Inspection* folder can also be imported into other reporting software such as *TubePro*.

# ECA Application Guide

## INTRODUCTION

---



The intent of this guide is to provide the user with the necessary knowledge to set up and properly operate an ECA probe.

## QUICK PROBE SELECTION GUIDE

---

### MECHANICAL DESIGN

Eddyfi offers several models of ECA probes. The 3 most popular probe types are described below.

Probe type	Picture	Purpose
Semi-flexible		Best suited for flat and curved surfaces, both concave and convex. Conform to outside diameter of 41 cm (16 in.) or more (depending on probe model). Combines part the flexibility of the flexible probe and the ruggedness and wear resistance of the rigid solutions.
Padded		Best suited for uneven surfaces that are reasonably smooth. Suited for smooth weld. Designed to adapt to weld crown of 5 mm (0.2 in.) or less.
Flexible		Ultra-flexible probe. Can conform to curved surfaces with a bend radius of 20 mm (0.787 in.) or more (depending on probe model).

*Probe types*

## TOPOLOGY

The term topology refers to how the coils are organized inside a probe and how they are activated. The table below describes some of the strengths and weaknesses of the most commonly used topologies.

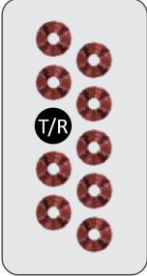
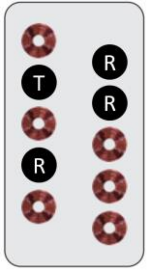
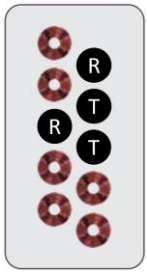
Topology	Coil arrangement	(+)	(-)
<b>Impedance Absolute (IMP or ABS)</b>		<ul style="list-style-type: none"> <li>• Non-directional (sensitive to defects in all orientations)</li> <li>• Sensitive to short, long and gradual defects</li> <li>• Fewer number of channels compared to transmit-receive modes</li> </ul>	<ul style="list-style-type: none"> <li>• Very sensitive to surface condition, probe handling</li> <li>• Sensitivity to lift-off (distance between the coils and the inspected surface)</li> <li>• Can't discriminate orientation of short defects</li> </ul>
<b>Long Single Driver (LSD)</b>		<ul style="list-style-type: none"> <li>• Typically used for detection of subsurface defects</li> <li>• Good performances on carbon steels (surface-breaking only)</li> <li>• Good tolerance to lift-off</li> </ul>	<ul style="list-style-type: none"> <li>• More limited in terms of smallest detectable flaw compared to the SDD topology</li> </ul>
<b>Short Double Driver (SDD)</b>		<ul style="list-style-type: none"> <li>• Good sensitivity to short and shallow defects</li> <li>• More sensitive to lift-off than LSD topology, but less than IMP topology</li> </ul>	<ul style="list-style-type: none"> <li>• Limited performances on ferromagnetic materials, especially for long defects</li> </ul>

*T = Transmitter, R = Receiver*



With the impedance absolute topology, each coil generates one channel.

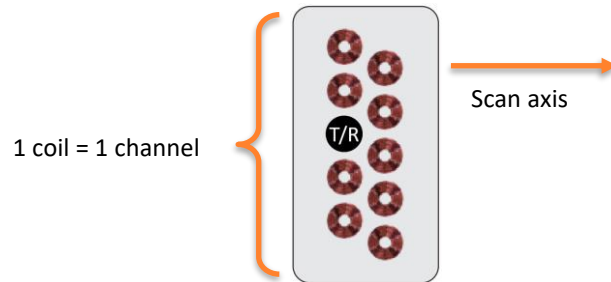

*Coil layout - Impedance Absolute topology*

The transmit-receive topologies (SDD and LSD) produce 2 different groups of channels each, the axial and the transverse. The transmit-receive groups are mostly sensitive to flaws oriented along the transmitter-receiver axis. Therefore, the axial group is mostly sensitive to axial flaws and the transverse group is mostly sensitive to transverse flaws. They are both sensitive to volumetric flaws as well. Each receiving coil produces one channel.

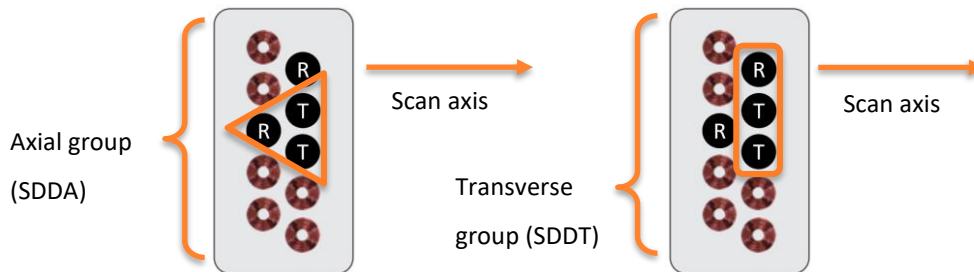

*Coil layout – Short Double Driver topology*

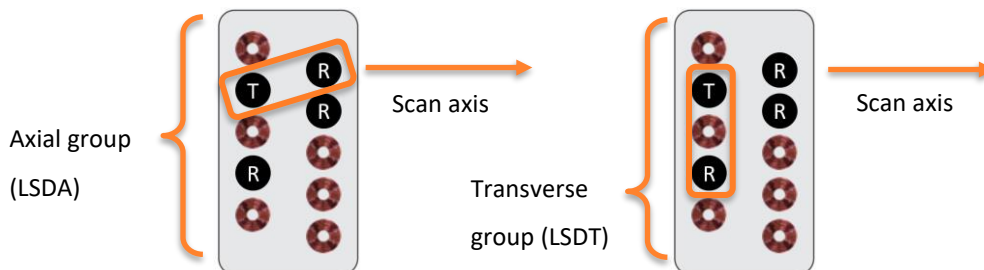

*Coil layout – Long Single Driver topology*

## COIL DIAMETER

The coil diameter have an impact on the followings:

- Minimum detectable flaw
- Depth of penetration

### MINIMUM DETECTABLE FLAWS

As a rule of thumb, one could use the following formula to estimate the length of the shortest surface-breaking defect that can be detected. The distance to be considered is the distance between the transmitter and the receiver. In the case of the Impedance Absolute topology, the diameter of the coils could be used as an estimate.

$$\text{Minimum detectable defect} = \frac{\text{Center - to - center coil distance}}{4}$$

Note that this represent an approximation and that real performances will vary according to many parameters such as the surface conditions, lift-off, permeability variations, etc.

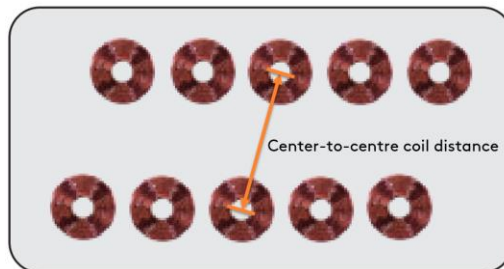

### DEPTH OF PENETRATION

The depth of penetration is directly related to the coil diameter. Generally, the capability of a coil to discriminate defects of different depths increases with the coil diameter. For instance, a 2 mm coil could discriminate defects having depths ranging between 0 and 2 mm. Past 2 mm deep, the signal amplitude may remain the same. Note that this represent an approximation and that real performances will vary according to many parameters such as the surface conditions, lift-off, permeability variations, etc.

Typically, you could consider that far-side defects could be detected if they have a depth of at least 25% of the wall thickness and a length of 1 to 2 times the wall thickness. Again, you should consider this as an approximation to get started. Of course, real performances will vary according to many parameters such as the surface conditions, lift-off, permeability variations, etc.

For far-side defects, you could also use the following formula as a first approach to estimate a potential operating frequency. Of course, the frequency range of a probe is typically related to the size of the coils.

$$f = \frac{1.6 \times \rho}{t^2}$$

**Where  $f$  is the operating frequency in  $kHz$ ,  $\rho$  is the resistivity of the inspected material in  $\mu\Omega \cdot cm$  and  $t$  is the remaining ligament of material between the surface (inspection side) and the bottom of the defect, in  $mm$ .**

**Important:** With the currently available range of ECA probes, subsurface defects can't be detected in carbon steel or other ferromagnetic materials having a high magnetic permeability, even if they are very close to the surface.

## PROBES DESCRIPTION

### I-FLEX™ PROBES

#### DESCRIPTION

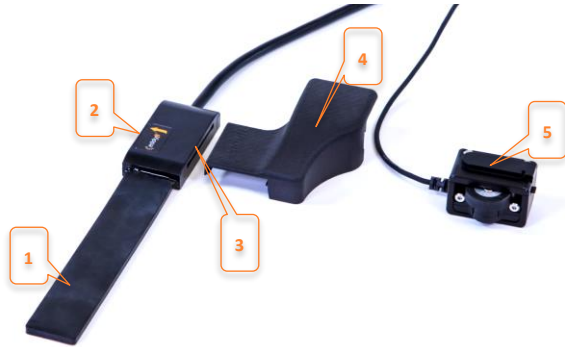

1. Flexible body
2. Scan direction arrow
3. Encoder holder slot
4. I-Flex encoder holder
5. High precision standard encoder

ECA-IFG-056-250-048-N03S with encoder

#### I-FLEX TOPOLOGIES



Up to three topologies can be activated:

1. Impedance Absolute
2. Short Double Driver
3. Long Single Driver

ECA-IFG-056-250-048-N03S – PCB

Probe model	Topology			Coil OD (mm)	Channels (according to topo.)	Central freq. (kHz)
	Short Double Driver	Long Single Driver	Imp. Abs.			
ECA-IFC-128-005-033-N03S		●*		6.0	32	5
ECA-IFG-079-250-048-N03S	●	●	●	5.0	60, 59, 32	250
ECA-IFG-079-050-048-N03S	●	●	●	5.0	60, 59, 32	50
ECA-IFG-056-250-048-N03S	●	●	●	3.5	60, 59, 32	250
ECA-IFG-056-050-048-N03S	●	●	●	3.5	60, 59, 32	50
ECA-IFG-034-500-048-N03S	●	●	●	2.0	60, 59, 32	500

\* Axial channels only

I-Flex topologies

## PADDED PROBE

### DESCRIPTION

- 1. Encoder slot
- 2. Scan direction arrow
- 3. Padded sensitive area
- 4. Coverage indicators

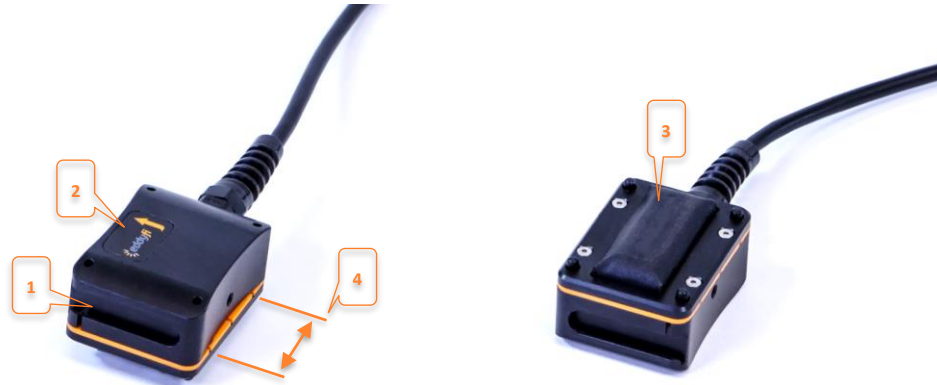

ECA-PDD-034-500-032-N03S

### TOPOLOGIES

Each padded probe can operate a single topology. It has either a Short Double Driver or a Long Single Driver configuration, depending on the model.

Probe model	Topology		Coil OD (mm)	Number of channels
	Short Double Driver	Long Single Driver		
ECA-PDC-058-250-032-N03S		●	3.5	59
ECA-PDD-056-250-032-N03S	●		3.5	60
ECA-PDC-055-500-050-N03S		●	2.0	95
ECA-PDD-054-500-050-N03S	●		2.0	96
ECA-PDC-035-500-032-N03S		●	2.0	59
ECA-PDD-034-500-032-N03S	●		2.0	60

*Padded probe topologies*

## SEMI-FLEXIBLE PROBE

### DESCRIPTION

1. Encoder slot
2. Scan direction arrow
3. Semi-flexible sensitive area
4. Coverage indicators

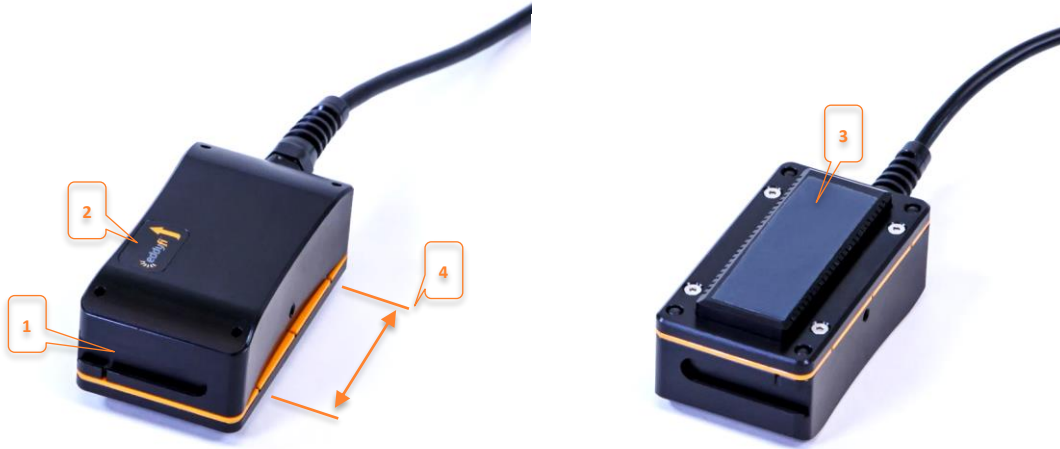

ECA-SFC-064-005-017-N03S

### TOPOLOGIES

Each semi-flexible probe can operate a single topology. It has either a Short Double Driver or a Long Single Driver configuration, depending on the model.

Probe model	Topology		Coil OD (mm)	Number of channels
	Short Double Driver	Long Single Driver		
ECA-SFC-128-005-033-N03S		●	6.0	32
ECA-SFC-064-005-017-N03S		●	6.0	16
ECA-SFC-058-250-032-N03S		●	3.5	59
ECA-SFD-056-250-032-N03S	●		3.5	60
ECA-SFC-071-500-064-N03S		●	2.0	123
ECA-SFD-070-500-064-N03S	●		2.0	124
ECA-SFC-035-500-032-N03S		●	3.5	26
ECA-SFD-034-500-032-N03S	●		2.0	60

Semi-flexible probe topologies

## SETUP

### LOAD / CREATE SETUP

5. Open Magnifi.



6. In the backstage, click on *Open Setup*.
7. From the Default Master List section, select the setup corresponding to the probe to be used.

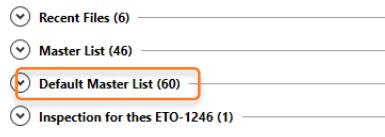

8. Connect the 160-pin array connector to the Ectane™ or Reddy™ unit.
9. Connect the 18-pin encoder connector to the Ectane unit or the 12-pin encoder connector to the Reddy.
10. **For the Ectane** instrument, connect the instrument to Magnifi by clicking on the  button located in the *Instrument* ribbon in the front stage.
11. **For the Reddy** instrument, the connexion to Magnifi is automatic.
12. Once connected, you will see in the General section of the backstage that the probe is detected.

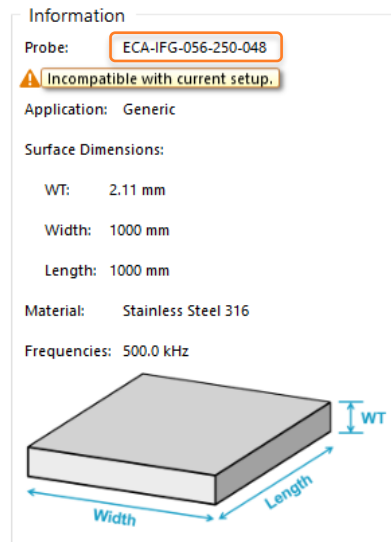

*Default I-Flex Setup in Default Master List*

*The I-Flex probe is detected by the instrument*

Note that you will get a warning message if the currently loaded setup is not compatible with the probe. The appropriate setup is not loaded automatically when a probe is connected. Make sure to select the

probe number that fits exactly with the one detected by the instrument, some model numbers in the list are very similar.

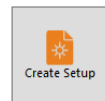
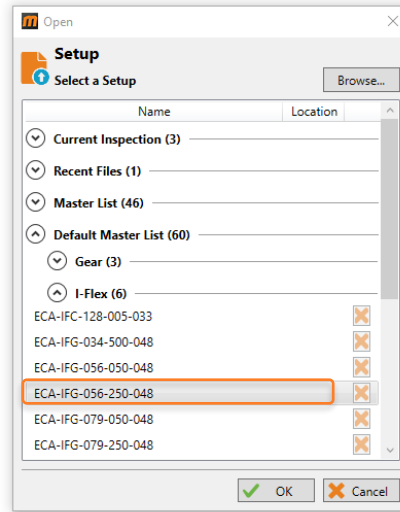

Alternatively, a setup can also be created using the setup Wizard by clicking on *Create Setup* from the General section of the backstage.



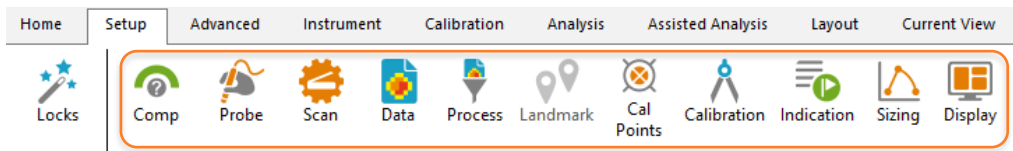





Note that all the steps of the Wizard are already filled with default values when creating a new setup or when loading one from the Default Master List. In any case, all the steps of the Wizard always remain accessible through the *Setup* ribbon in the front stage if you want to apply modifications to your setup.



*All the Wizard steps are accessible in the Setup ribbon*



The table below presents the principal settings and their respective Wizard steps.

Wizard step	Parameters
 Scan	Encoder settings C-Scan size Oversampling (interpolation)
 Data	Gain Topology Frequency Driver voltage
 Process	Filters
 Cal Points	Calibration points
 Calibration	Calibration settings
 Indication	Indication Codes
 Sizing	Sizing curves
 Display	Layout Display settings

## ENCODER SETTINGS

13. In the frontstage, go to the *Setup* ribbon and open the *Scan*  menu.
14. To enable the encoder, set the parameter *Position from* to *Encoder*. To disable the encoder, choose *Clock* from the drop-down list. Click *Next*.

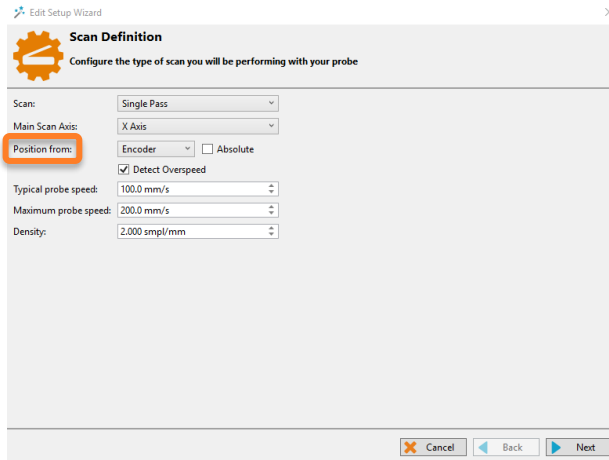

Scan Definition, page 1

15. On the second page of the *Scan Definition* step, in the *Encoder* section, make sure your encoder resolution matches the one set in the software:

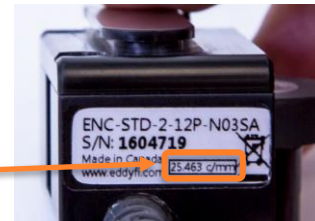
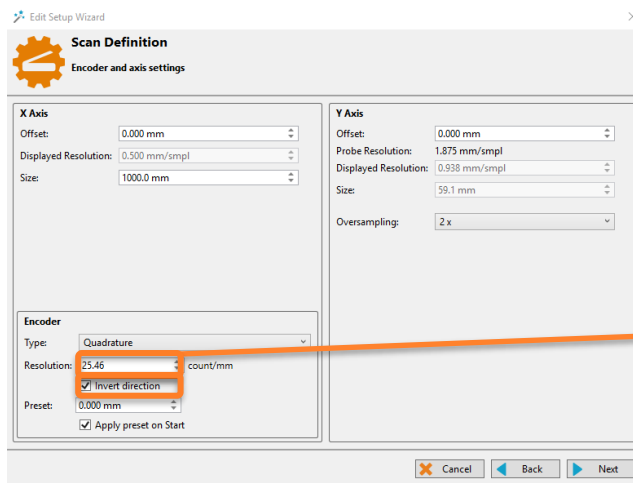

Scan definition, page 2

16. Depending on the orientation of the encoder relative to the probe and scanning direction, you might have to *Invert* direction to make sure that the positions provided by the encoder are going in the same direction as the probe scanning axis.
17. Click *Next* on all the following pages, then *Finish*.

## IMPEDANCE ABSOLUTE LAYOUT

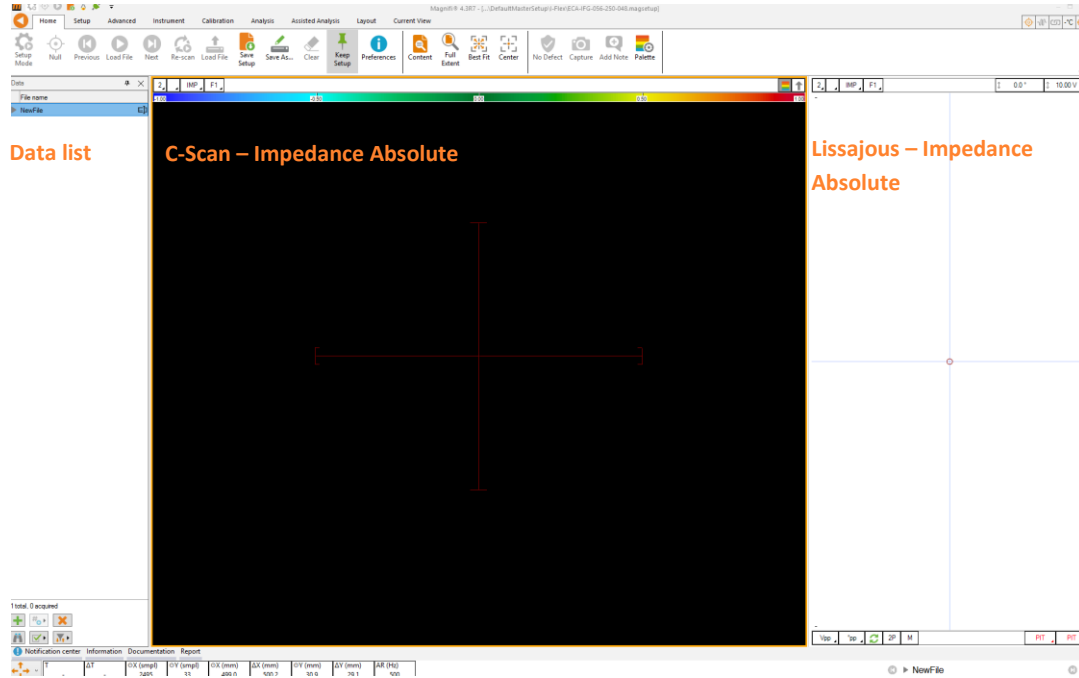

*Impedance Absolute layout*

A probe used in Impedance Absolute mode produces a single group of channels and therefore the setup has a single C-Scan. Each horizontal line in the C-Scan represents one channel.

The C-Scan view displays the vertical component of the Lissajous view since the signal component selector (arrow button at the top right of the C-Scan) is set to vertical by default. Only one channel at a time is displayed in the Lissajous view. It corresponds to the C-Scan line under which the horizontal cursor is located.

## TRANSMIT-RECEIVE LAYOUT

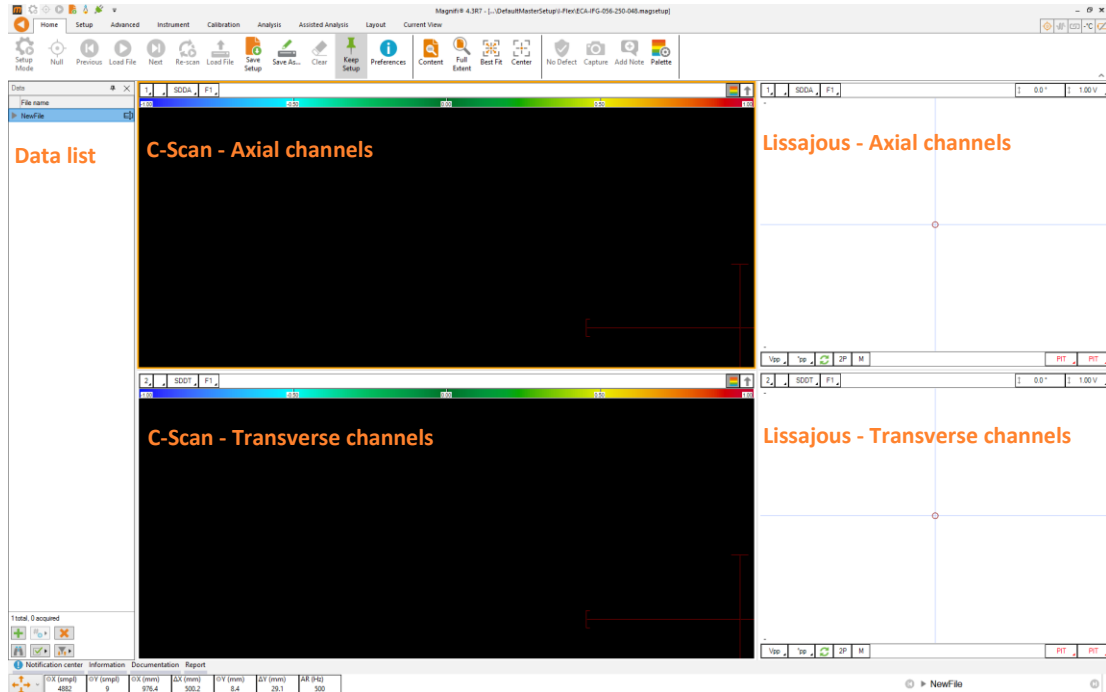

*Transmit-receive layout*

A probe used in Transmit-Receive mode typically produces 2 groups of channels and therefore the setup has 2 C-Scans. Each horizontal line in a C-Scan represents one channel.

The C-Scan view displays the vertical component of the Lissajous view since the signal component selector (arrow button at the top right of the C-Scan) is set to vertical by default. Only one channel at a time is displayed in the Lissajous view. It corresponds to the C-Scan line under which the horizontal cursor is located.

## OPERATING FREQUENCY SELECTION

The selection of the right frequency can greatly affect the results.

By default, the frequency set by the Wizard is simply the central frequency of the coils. Note that depending on the material under test and the target defects' type and dimensions, the optimal frequency can vary. You can consult the first section of this document to guide you through the selection of the operating frequency.

The following steps will suggest a typical workflow that can be used when adjusting the frequency. Ideally, a representative sample of the material to inspect with a target defect would be used.

18. Some probes like the I-Flex offer several topologies. Open the *Data*  step and validate that you are using the desired topology.

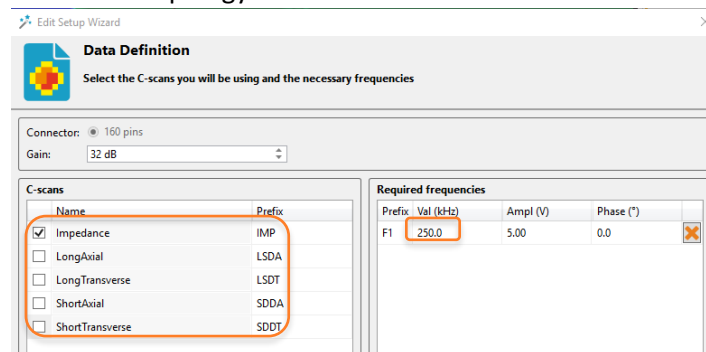

Data definition page

19. Still in the *Data*  step, select the desired frequency. Click on *Finish*.

20. Make sure that no filter is applied. Indeed, the filters could remove the signal coming from the lift-off, which needs to remain visible for the frequency selection and validation. To disable the

filters, verify that the filter options are unticked in the *Process*  menu.

21. Deactivate the encoder. To do so, open the *Scan* menu  and set the *Position from* to *Clock*.

22. Place the probe on a flawless portion of the sample applying an even pressure and null your

probe by clicking on the *Null*  button.

23. Start the acquisition  and collect a material-air signal by lifting the probe away from the sample's surface. This is the lift-off signal.



Material



Air

*Performing a lift-off with the I-flex probe*

24. Without stopping the acquisition, put the probe back on the material and scan over a target defect. In the picture below, the defect is a long notch, but ideally the defect would be representative of the target defects.

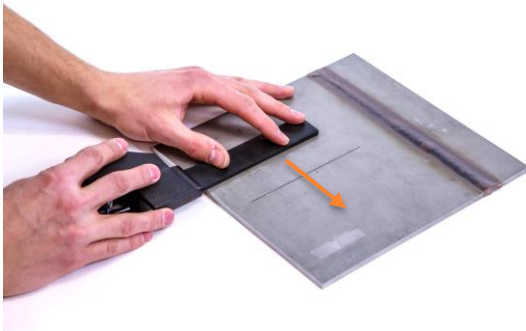

*Scanning the notch*

25. Click on  Stop acquisition

Note that the data shown below were acquired using an Impedance Absolute topology over stainless steel material. These images are used to illustrate the frequency selection concept. However, you should keep in mind that the shape of the signals will vary according to many parameters such as the topology, the frequency, the material, the defect type and dimensions, etc. and could be quite different than those shown here.

26. In the C-Scan view, place the cursor on the lift-off signal, as shown below.

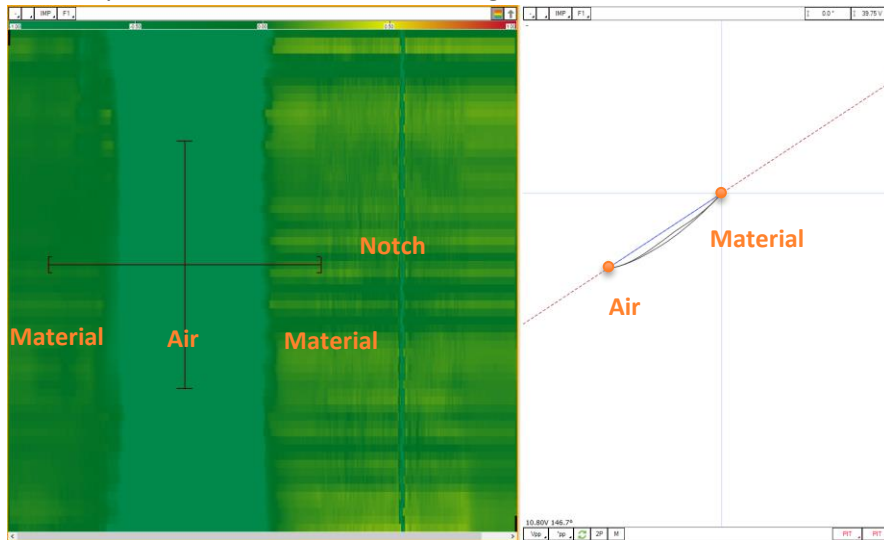

*Lift-off signal*

27. In the Lissajous view, rotate the signal so that the first portion of the lift-off signal is horizontal. The material operating point should be on the right, with the first portion of the lift-off going towards the left. You can use the rotation button at the top-right corner of the Lissajous.

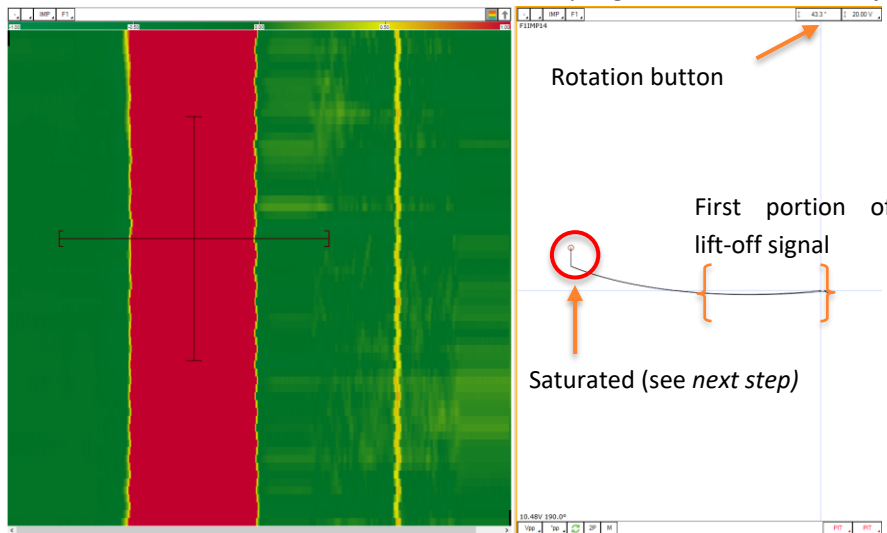

*Lift-off signal, rotated*

28. The previous image shows that the signal is saturated. Depending on the application, it might be acceptable, especially if very little lift-off variations are expected during the scans. However, it could be a good practice to avoid saturation. To do so, open the [Data definition page](#)  , decrease the *Gain* and perform another acquisition. Decrease the Gain by small steps until a non-saturated signal is obtained.

Note: Inversely, you can increase the gain (or voltage) if the signals are too small.

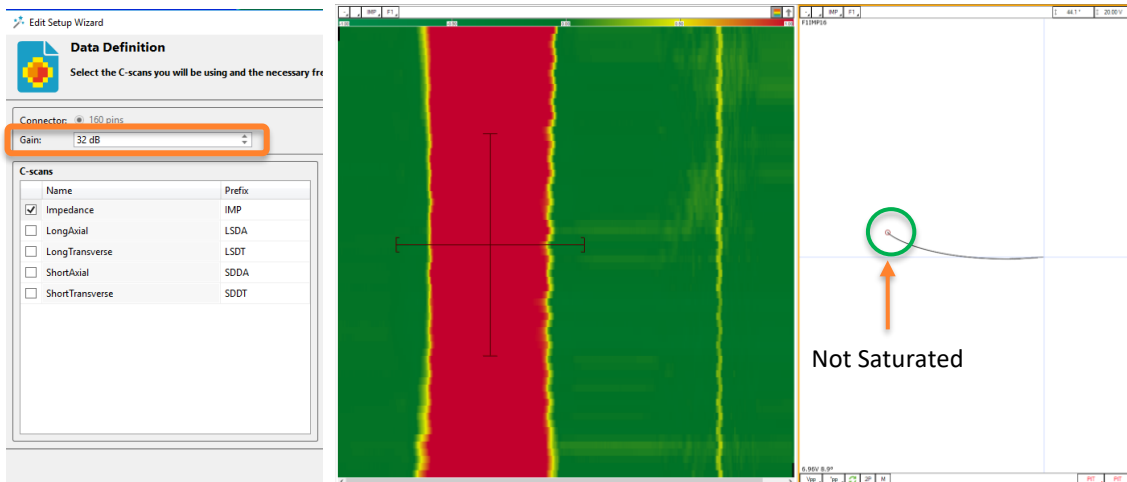

*Lift-off signal, rotated, without saturation*

29. In the C-Scan view, place the cursor over the lift-off and defect signals so you can observe both of them simultaneously in the Lissajous. You might want to modify the frequency in order to improve the detection of the target defect or to increase the phase separation between the lift-

off signal and the defect signal. The frequency can be modified in the Data definition page  .

Note that changing the frequency will modify the shape and rotation of the signals, so you will need to repeat all the previous steps every time you modify the frequency.

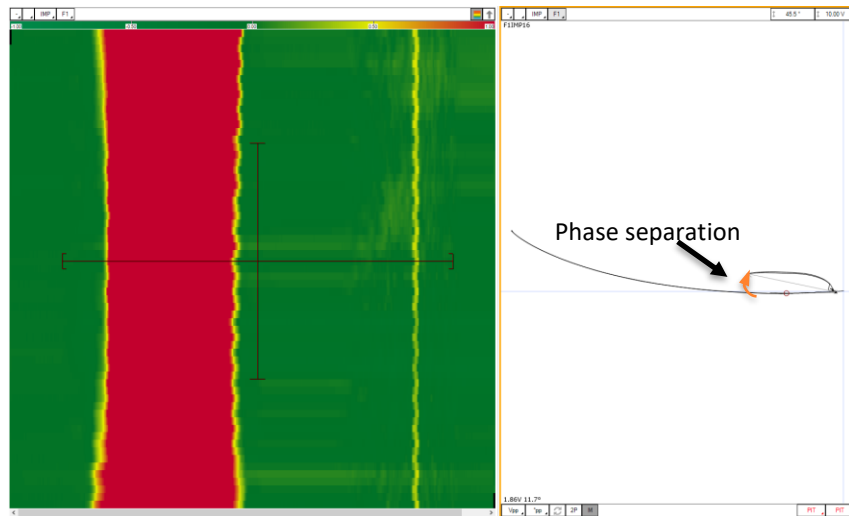

*Lift-off signal and notch signal*

## CALIBRATION

In order to obtain optimal detection, a probe *calibration* should be performed. This step requires a calibration plate or block with a long notch. The purposes of the probe calibration are:



- Adjusting the overall rotation and amplitude of the signals so that target defects provide the desired amplitude and phase.
- Uniformize the response in amplitude and phase for all the channels so they provide the same response over the same defect.

## CALIBRATION PLATE PREPARATION

Prepare the calibration plate. It must have a notch at least 20 mm longer than the total coverage of the probe to facilitate the manipulations and also make sure that the channels at both ends of the array are not seeing edge effects.

The coverage in millimeters is indicated in the probe acronym. For example, the coverage of the probe ECA-PDD-**056**-250-032-N03S, is 56 mm. Therefore, it would be recommended to have a notch with a length of approximately 76 mm.

Also, the notch should be located far enough from the edges of the plate to ensure that the calibration scans can be performed without reaching the edges.

Finally, the dimensions of the notch (width and depth) should ideally be similar to the dimensions of the target defects.

## CALIBRATION OF TRANSMIT-RECEIVE CHANNELS

**Important:** The frequency selection must be performed prior to the calibration. See previous section.

Also, note that the data shown below were acquired using a Short Double Driver topology over stainless steel material. These images are used to illustrate the probe calibration concept. However, you should keep in mind that the shape of the signals will vary according to many parameters such as the topology, the frequency, the material, the defect type and dimensions, etc. and could be quite different than those shown here.

With the transmit-receive topologies, two groups of channels have to be calibrated, the axial channels and the transverse channels. The following steps will show how to:

- Properly acquire the reference signals for calibration of each group of channels;
- Adjust the rotation so that the lift-off is horizontal (as shown in the previous section).

30. In the Process menu  , turn off the median filters.

31. In the Scan menu  , set the *Position from* to *Clock*.

32. Place the probe on a flawless portion of the plate and click the Null button  .

33. Start the acquisition  and perform a material-air signal (lift-off signal).

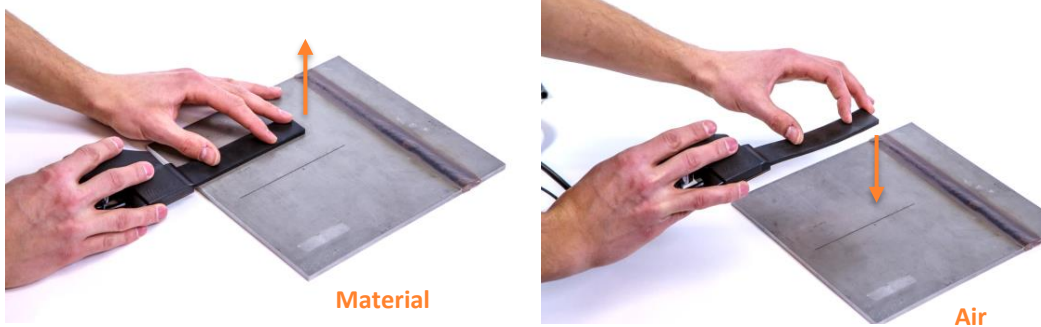

*Performing a lift-off with the I-flex probe*

34. Without stopping the scan, perform a scan with the probe parallel to the notch. This signal will be used for the calibration of the transverse channels since it simulates a transverse indication.

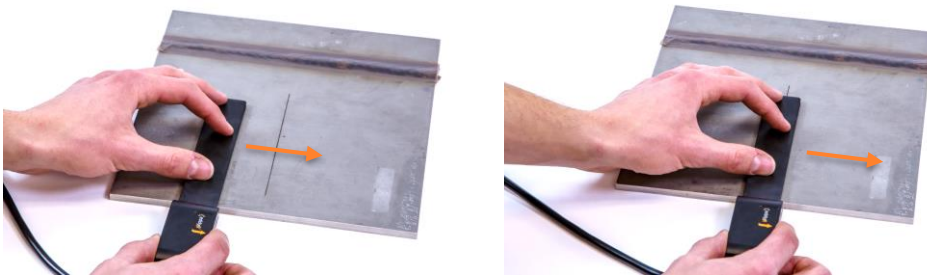

*Scanning the notch to produce a transverse indication*

35. Without stopping the scan, rotate the probe 90° and place it back on the plate as shown on the next figure.

36. Null  the probe again.

37. Perform a scan with the probe perpendicular to the notch. This signal will be used for the calibration of the axial channels since it simulates an axial indication.

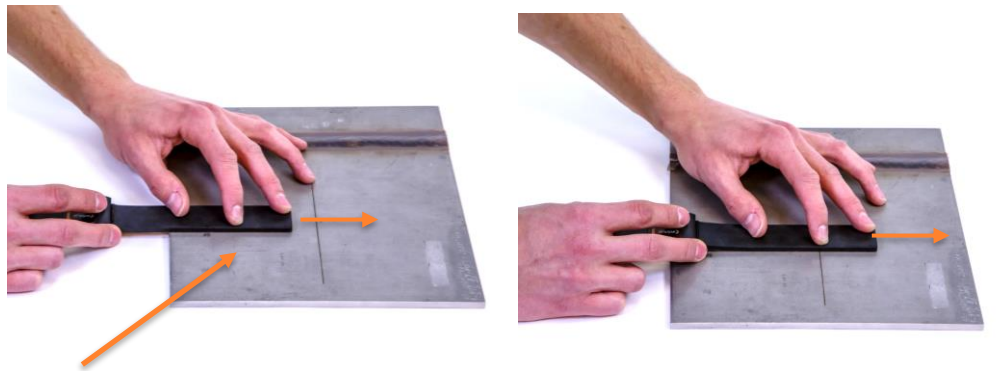

Null again here

Scanning the notch to produce an axial indication

38. Click on *Stop* acquisition  .

**Important:** If your C-Scan is not long enough to perform the lift-off signal, the transverse notch signal and the axial notch signal, increase the C-Scan size in the Scan menu, in the *Encoders and axis setting* page



Scan

39. Place your cursor on the lift-off signal.

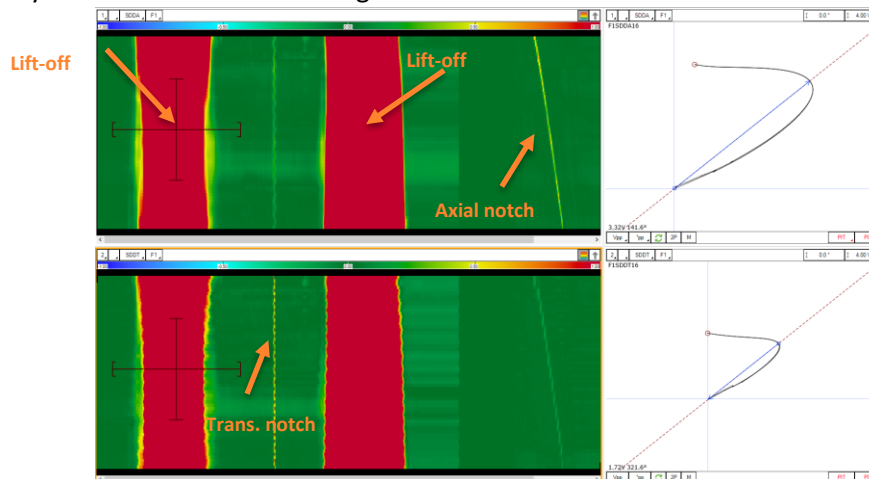

Short double driver - Lift-off and notch signal

40. For both the axial and the transverse channels, in the Lissajous view, rotate the signal so that the first portion of the lift-off signal is horizontal. The material operating point should be on the right, with the first portion of the lift-off going towards the left. You can use the rotation button at the top-right corner of the Lissajous.

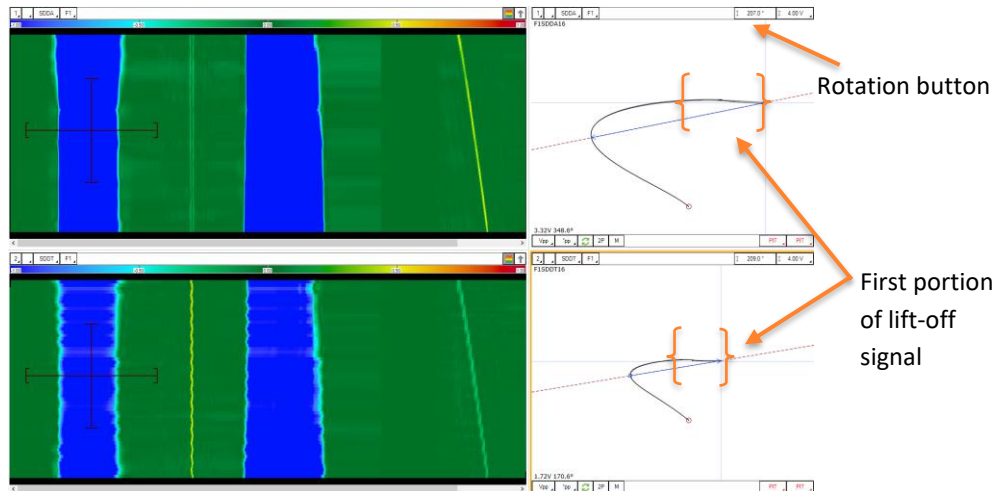

Short double driver - Lift-off and notch signal - rotated signal

Now, the following steps will show how to:

- Set the target values of amplitude and phase for calibration;
- Perform the calibration.

41. In the Lissajous view, click and hold the *Amplitude measurement button*, a contextual menu will open.

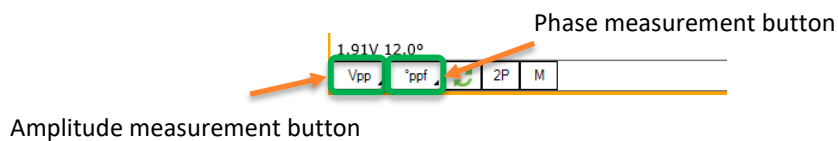

42. From this menu, select the amplitude measurement method. It is recommended to use *Peak to Peak (Vpp)*.

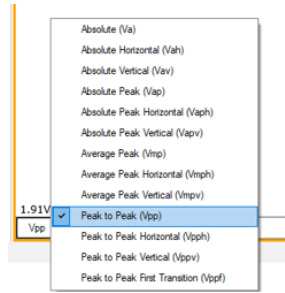

43. In the Lissajous view, click and **hold** the *Phase measurement button*, a contextual menu will open.

44. From this menu, select the phase measurement method. It is recommended to use *Peak to Peak first transition (Vppf)*.

45. Place your cursor over the first notch indication which represents a transverse indication.

46. From the transverse Lissajous view, look at the measured amplitude and phase of the indication. You should move the cursor up and down in the C-Scan to look at the different transverse channels and should notice an average value of amplitude and phase. Note those average values for later.

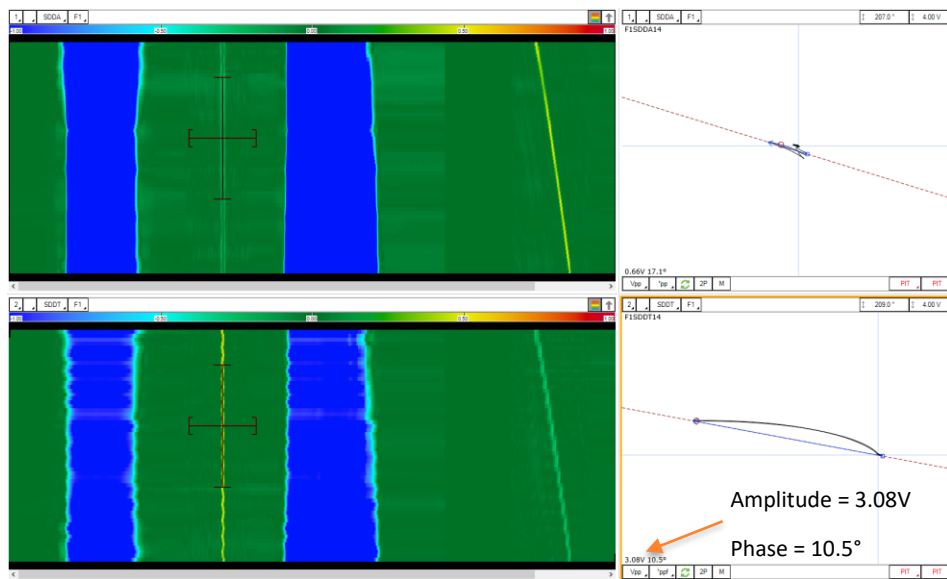

Cursor placed over the “transverse” notch

47. Place your cursor over the second notch indication which represents an axial indication and repeat the previous step.

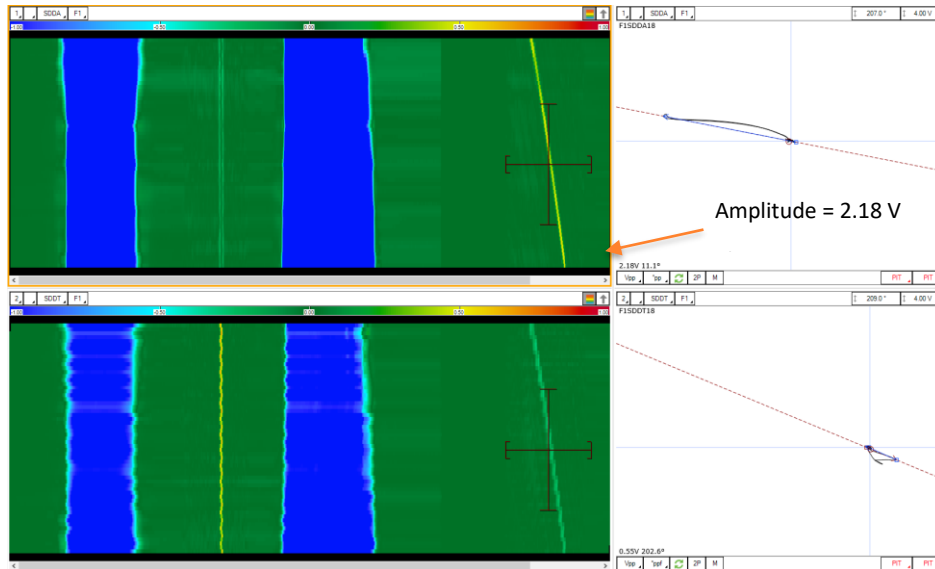

*Cursor placed over the "axial" notch*

48. In the Wizard ribbon, open the calibration step



49. Enter the amplitude and phase values that were noted at the previous steps in their respective fields. Make sure to use the axial reference for the axial C-Scan and the transverse reference for the transverse C-Scan. Also, it is recommended to use the Peak to Peak measurement method for amplitude and Peak to Peak first transition for phase.

Note that you can adjust the amplitude to a desired target value, it does not have to be exactly the same as what was previously measured. However, it is recommended to enter an amplitude value that is close to the initially measured value. If the desired target value is far from what has been measured, it could be a good practice to adjust the voltage and/or gain accordingly and repeat the previous steps. For the phase, it is recommended to use a number as close as possible to what was previously noted to make sure that the lift-off keeps the right orientation.

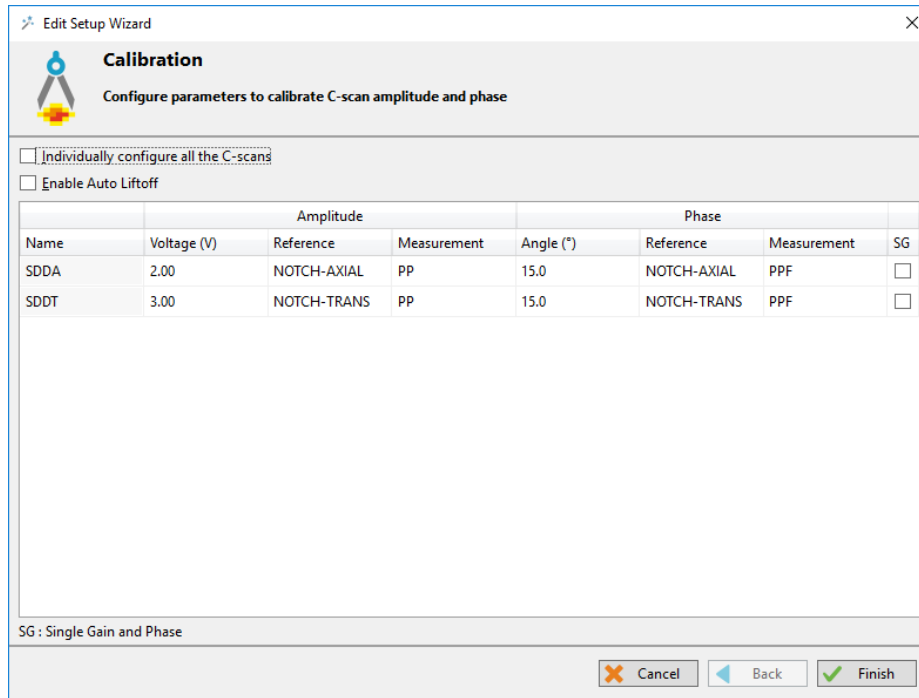

Calibration page

50. Click on Finish.

51. From the Calibration ribbon, open the System Calibration menu . This button will open the following menu.

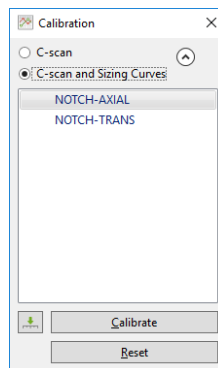

52. Keeping this menu open, in the C-scan, place your cursor over the transverse calibration notch signal. Make sure that the horizontal cursor is wide enough to encompass completely the indication, but not too wide to avoid grabbing the lift-off signal or other sources of noise near the indication.

53. Select the transverse calibration reference from the opened calibration menu, press the green arrow .

54. In the C-scan, place your cursor on the axial calibration notch signal. Make sure that the horizontal cursor is wide enough to encompass completely the indication, but not too wide to avoid grabbing the lift-off signal or other sources of noise near the indication.
55. Select the axial calibration reference from the opened calibration menu, press the green arrow



56. Click on Calibrate.

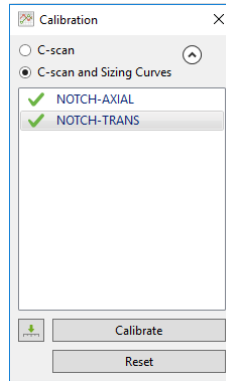

Calibration window, 2 channels to calibrate

57. Perform a quick calibration check. Place the cursor over the indications to validate that the measured amplitude and phase correspond to the parameters configured previously. Your probe is calibrated.

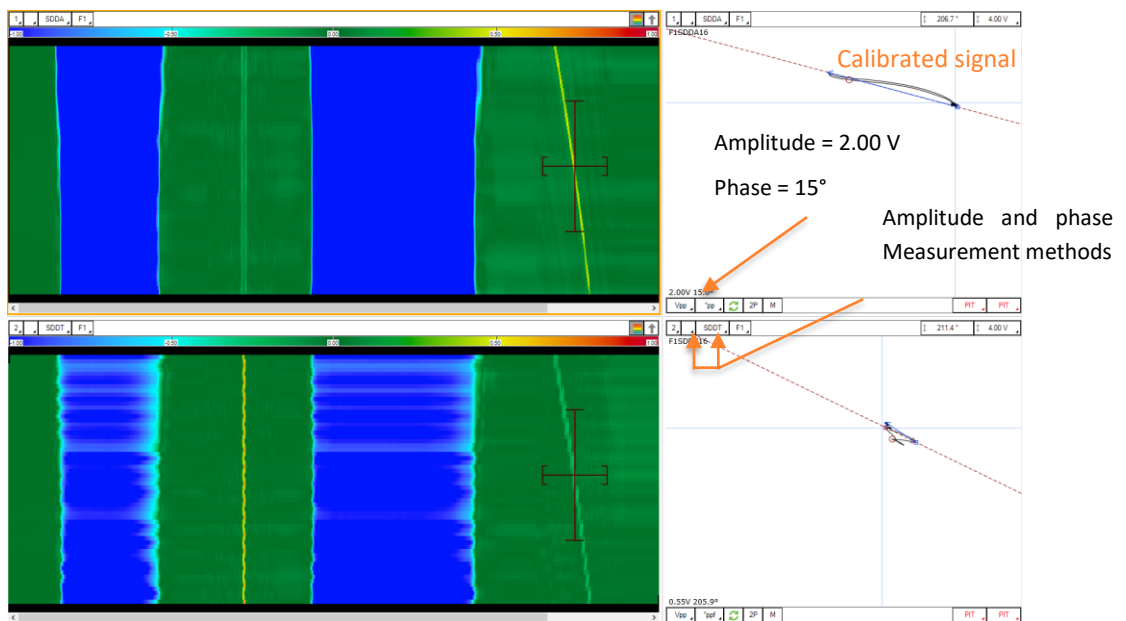

Transverse notch signal after calibration

## CALIBRATION OF IMPEDANCE ABSOLUTE CHANNELS

You should follow the same procedure as explained previously for the transmit-receive channels. The only differences are that:



- Only the first pass over the notch is required since there is only one group of channels and it is equally sensitive to all orientations.
- The menus will have only one reference signal, as shown below.

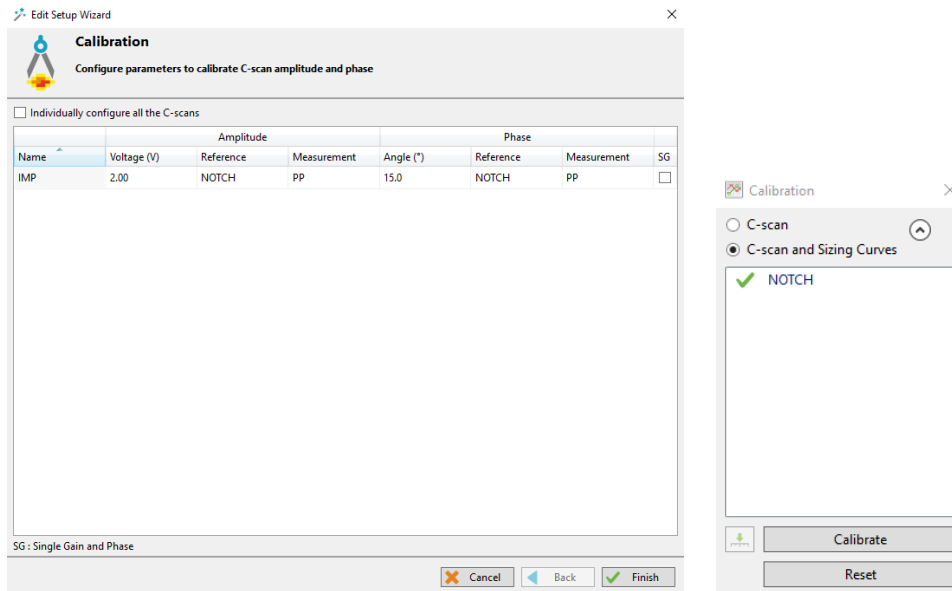

## CALIBRATION WITH SINGLE GAIN AND PHASE

If no calibration plate with a long notch is available, it is therefore impossible to perform a full calibration of your array probe. However, if a sample with a target defect is available, it remains possible to perform a partial calibration using the Single Gain and Phase mode.

This type of calibration will not uniformize the response in amplitude and phase for all the channels so there will remain variations from one channel to the others.

However, it will at least allow for an adjustment of the overall rotation and amplitude of the signals so that target defects provide approximately the desired amplitude and phase.

To perform a Single Gain and Phase calibration, follow the same steps as for the full calibration of the transmit-receive channels, but in the Calibration page of the Wizard make sure to check the SG option (Single Gain and Phase) for all the groups.

SG : Single Gain and Phase

Name	Voltage (V)	Amplitude		Angle (°)	Phase		SG
		Reference	Measurement		Reference	Measurement	
SDDA	2.00	NOTCH-AXIAL	PP	15.0	NOTCH-AXIAL	PPF	<input checked="" type="checkbox"/>
SDDT	3.00	NOTCH-TRANS	PP	15.0	NOTCH-TRANS	PPF	<input checked="" type="checkbox"/>

## ACQUISITION

---

The following steps suggest a standard acquisition workflow. In this case, a smooth stainless steel weld will be scanned with an I-Flex probe.

58. If the filters have been disabled to perform the frequency selection and calibration, make sure

to re-enable them by going In the Process menu  .

59. Also, you can re-activate the encoder if desired. In the Scan menu  , set the *Position from to Encoder*.

60. In the Home ribbon, uncheck the Setup Mode  .

61. In the Data tab on the left side of the front stage, add an Inspection file, by clicking on the green cross. If the Data tab is not available, go to the Layout ribbon and enable it by clicking on the

Data button  .

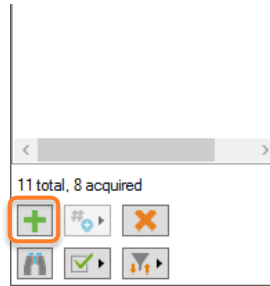

*Adding an inspection data in the data list*

62. Null  the probe on a flawless section of the weld and start the acquisition.



*Scanning a weld with the I-Flex probe*

63. During the scan, you should try to keep a constant pressure. Also, you should try to keep the same index position (up-down) when scanning a constant feature such as a weld, an edge, a radius, etc. This will generally provide better data quality.
64. Stop the acquisition.
65. Your data file is automatically saved in your Inspection file (if the Setup mode is disabled and the Automatic File Recording option from the General Preferences section in the backstage is enabled).

## MAINTENANCE

---

- The probes are not watertight. Do not immerse in water, as this may cause the probes to malfunction.
- To clean the probes, use a soft, humid cloth. Do not use harsh chemical cleaners, as it may damage the probes.
- The probes must be used with adequate setup file.

# Sharck™ G2 Application Guide

## PROBE DESCRIPTION

---

### BUTT WELD

1. Keypad (see section 1c)
2. Active area markers
3. Scan direction
4. Strap attachment
5. Removable embedded encoder (see section 0 for cleaning)
6. Wheels (see section 0 for cleaning)
7. Removable frame to clean fingers (see section 0)
8. Fingers with TECA™ elements (22)



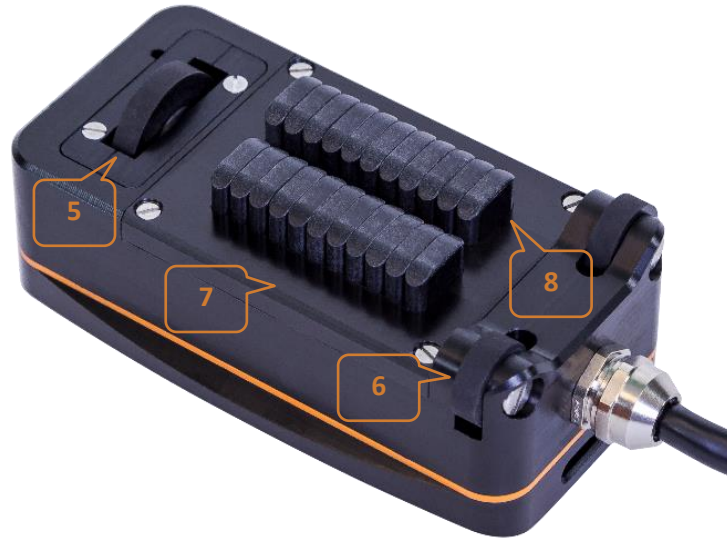

Figure 2. Sharck-Butt Weld features

## FILLET WELD

1. Keypad (see section 0.)
2. Active area markers
3. Scan direction
4. Spring loaded side wheels
5. Side wheels adjustment buttons (see section 0 IV)
6. Adjustable module screw

- 7. Spring loaded embedded encoder
- 8. Wheels (see section 0 for cleaning)
- 9. Removable frame to clean fingers (see section 0)
- 10. Adjustable module fingers (6)
- 11. Fixed module fingers (6)

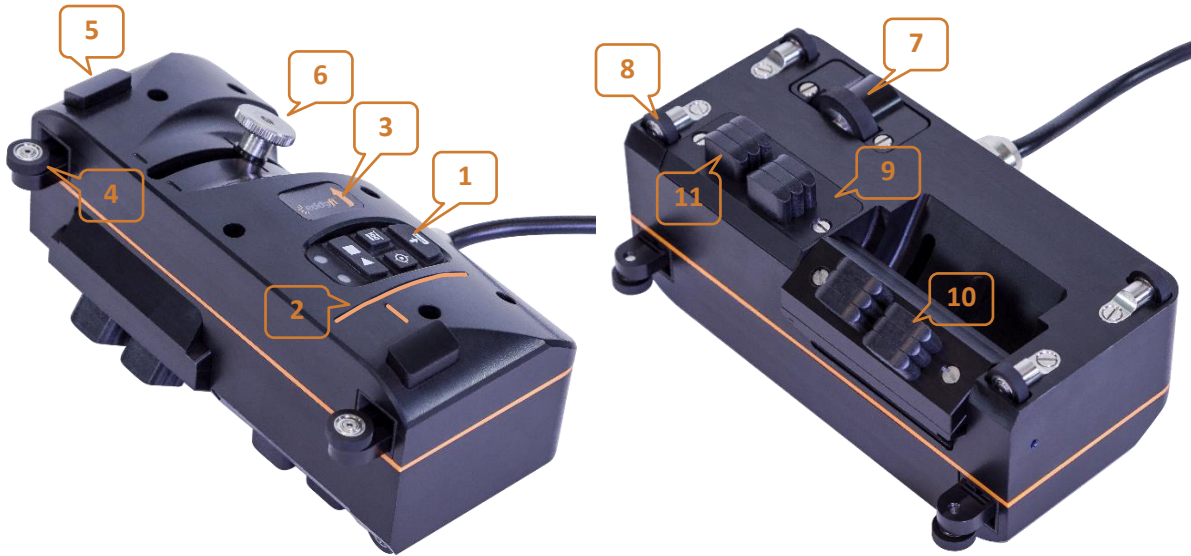

Figure 3. Sharck-Fillet Weld features



## KEYPAD

1. LED: Green LED turned on during an acquisition (not functional on 1st generation of Ectane®)
2. Start/Stop an acquisition
3. Null the probe
4. Calibration wizard
5. Save data (currently not functional on Reddy®, but will be implemented in a future version of Magnifi)

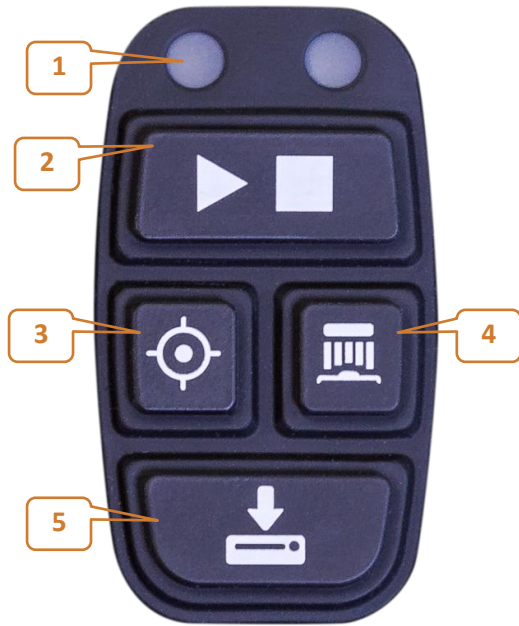

Figure 4. Keypad features

## KEY CHARACTERISTICS

Type of defect	Fatigue cracking (axial and transverse to weld)
Conformability	Conforms to weld
Coverage	53 mm (2.1 in)
Channels requirements	64
Minimum pipe OD	25.4 mm (10 in) for circumferential scans 40.6 mm (16 in) for axial scans
Detection capabilities	Axial and transverse From 3 x 0.5 mm (0.12 x 0.02 in)
Sizing capabilities	Axial only From 12.5 x 1 mm (0.5 x 0.04 in) Up to 7 mm (0.28 in) deep Up to 3 mm (0.12 in) Lift-off
Temperature	100 deg C (212 F)
Maximum probe speed	Up to 200 mm/s (7.9 in/s)

## MATERIAL COMPATIBILITY

---

The User Mat calibration that will be discussed later in this User guide is mainly useful to compensate for permeability changes which may occur during scans, either along a same part being inspected or simply, between alloys having different properties. Permeability changes affect signal amplitude for a given flaw, this is then the reason why there is a need to compensate for it, assuring accurate depth sizing on each individual crack. The Sharck probes were primarily designed for the assessment of surface breaking cracks in carbon steel material and welds. Those can also be used to derivates to a certain extend.

### Carbon steels (most of construction steels)

- Reliable detection.
- Reliable length and depth sizing.

### Alloy steels

- Reliable detection
- Reliable length sizing but possible underestimation of depth sizing (specifically Nickel based one).

***Note: A dedicated sizing matrix, hence setup file can be produced for specific alloys providing a sample with EDM notches is made available to Eddyfi.***

### High strength low alloy (HSLA) steel

- Reliable detection.
- Reliable length and depth sizing.

***Note: Forged steels can be carbon steels, alloy steels or HSLA steels. Same capabilities as mentioned above.***

## MAGNIFI SETUP

---

Make sure to use Magnifi 4.4 or Magnifi GO 1.5 (or a more recent version).

Click Open setup  and select the setup corresponding to the probe in the Default Master List.

Connect the 160-pin ECA probe connector to an Ectane or Reddy unit.

Connect the 18-pin encoder connector to the Ectane I/O connector or the 12-pin encoder connector to the Reddy I/O connector.

For Ectane only: connect  the instrument to Magnifi.

## DATA MANAGEMENT

---

This section suggests a convenient way to manage and save automatically large amounts of data files during an inspection. The following steps can be done in advance in Magnifi (or Magnifi GO), before getting to the inspection site.

In the backstage of Magnifi, in the Inspection menu, select a project folder and an inspection folder .

In the Acquisition menu, select the Prefix filename option.

Click Create New List .

Select the prefix for the data file list, the number of files in the list, the index for the first data file and the index increment between each file. The example below shows a data file list based on the following parameters:

### Selected parameters:

<b>Resulting datafile list:Prefix:</b>	TECA
<b>Number of elements:</b>	4
<b>Element start number:</b>	10
<b>Element increment:</b>	2

Prefix	Index
TECA	010
TECA	012
TECA	014
TECA	016

Click Create.

In the frontstage, in the Layout tab, make sure the Data button is checked. The data file list will be displayed on the left side of the screen.

At the bottom of the data file list, click Acquisition preferences , and check the following two options:

Automatic file recording.

Automatic Next on Stop Acquisition.





When an acquisition is stopped, these two options allow to automatically save the data file and select the next one in the list. The user can then start the next acquisition, without any other action required.

Once the setup parameters and preferences are settled and the probe has been calibrated (see section 4), uncheck Setup Mode  in the Home tab.





In the data file list, select the first file to be acquired. The inspection can then begin.

A few more information about data management in Magnifi and Magnifi GO:

- The small icon beside each data file indicates its current state:

Icon	Definition
	The datafile was acquired and saved, but has not been analyzed yet
	The datafile was acquired, saved and analyzed, and it was reported as being defect-free
	The datafile was acquired, saved and analyzed, and defects have been reported
	The datafile has not been acquired yet (empty file)
	The datafile is tagged for further review

For more information on data analysis, refer to section 7 of this user guide.

- At any time during the inspection, the user can click *Add data*  or *Delete data*  at the bottom of the datafile list. Datafiles added with this button will keep the same prefix, and their index will be incremented by the number selected in the index menu . To create datafiles with a new prefix, go back to the backstage and click *Create New List*.
- To re-scan a datafile that has already been acquired and saved, right-click on the datafile (or hold the Reddy's touchscreen) and click *Re-scan*. To choose whether the original datafile should be kept or erased, select the corresponding option in *Acquisition preferences* .

## LAYOUT

1. Dp-Proc C-scan: Visualisation of axial cracks with material permeability and lift-off compensations. Each horizontal line corresponds to a channel of the probe.
  - ➔ Used to localize axial cracks indications, in combination with Lg C-scan.
2. Dp-Raw Lissajous: Raw impedance signal of the channels underneath the cursor in the Dp-Proc.
  - ➔ Used for depth measurement of axial cracks.
3. Lg C-scan: Visualisation of axial cracks ends.
  - ➔ Used to localize axial crack indications quickly, in combination with Dp-Proc C-scan, and size the cracks length.
4. Lg Lissajous: Signal of the channels underneath the cursor in the Lg C-scan.
5. Tr Strip chart: Superimposed strip charts of the transverse channels.
  - ➔ Used to detect transverse crack.
6. Compensated Depth: Depth measurement of the axial crack, up to 7 mm (0.28 in), with compensation for lift-off and permeability.
7. Length: Length measurement of the axial crack.
8. Lift-off: Local lift-off measurement, up to 3 mm (0.12 in).

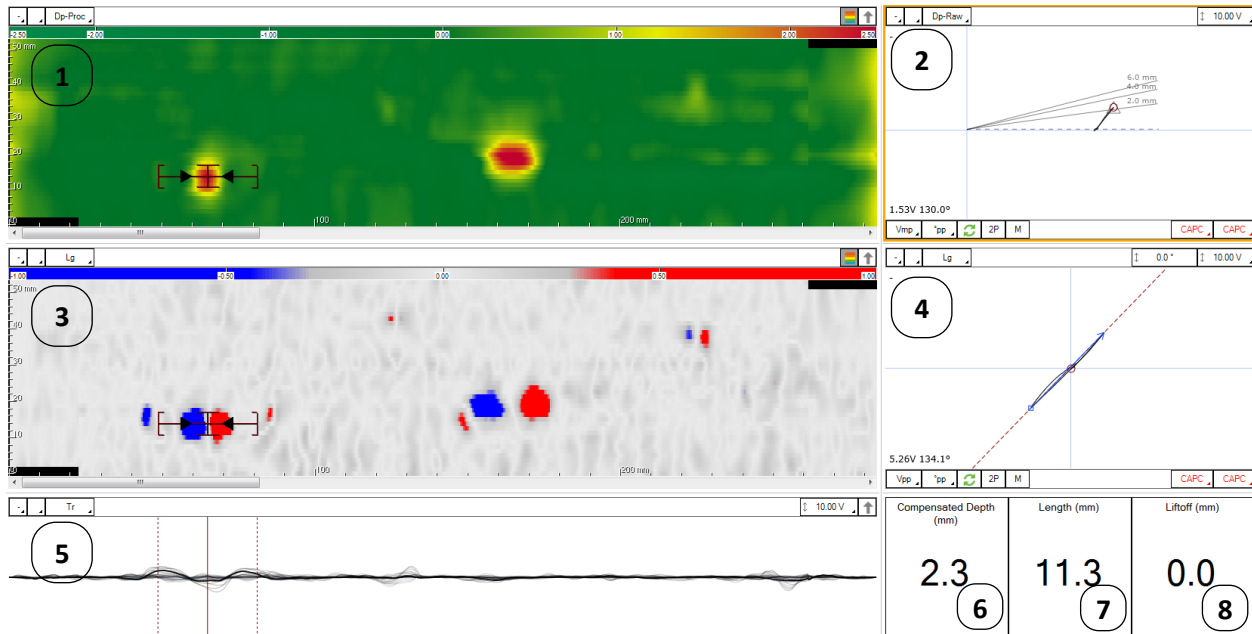

Figure 5. Sharck BW / FW acquisition and analysis layout



**Note: To change the settings of any of these windows or to access the Transverse C-Scan, select it and go to the Current View tab.**

## PROBE CALIBRATION

---

### CALIBRATION FROM THE SHARCK MENU

The following calibration should be performed before beginning a new inspection:

- I) Place the probe in the air, away from any metallic surface, then click Null .
- II) In the *Sharck* menu, click *Calibration* .
- III) Keep the probe in the air and click .
- IV) Put the probe in the middle of the aluminum plate supplied for calibration purposes and apply pressure to ensure that all wheels are in close contact with the surface, then click .

**Note1:** For the *Fillet Weld* probe, make sure that the adjustable module is set flat.

**Note2:** Ensure the Aluminium plate is placed away from any conductive material prior to performing the calibration.



Figure 6. Sharck probes on aluminium plate

- V) Place the probe on the weld to be inspected.

**Note:** For the *Fillet Weld* probe, ensure the adjustable module is set correctly to the weld cap under assessment.





- VI) Click  and move the probe along the weld.
- VII) Click .
- VIII) Close the Sharck calibration window.



Figure 7. Sharck probes on carbon steel weld

## CALIBRATION FROM THE PROBE KEYPAD

It is also possible to calibrate the probe using the calibration button  on the probe's keypad. The overall process does not change; only the clicking operations change:

- I) Place the probe in the air, away from any metallic surface, then press the Null button  on the probe.
- II) Press the calibration button  on the probe.
- III) Put the probe in the middle of the aluminum plate (supplied for calibration purposes) and apply pressure to ensure that all wheels are in close contact with the surface, then press the calibration button  on the probe.
- IV) Place the probe on the weld to be inspected.
- V) Press the calibration button  on the probe and move the probe along the weld.
- VI) Press the calibration button  on the probe to calibrate the probe.
- VII) Press any button on the probe to close the calibration window.



## ACQUISITION

---

### BUTT WELD

- I) Null the probe in the air.
- II) Place the probe on the weld. Use the marker lines on top of the probe to center it on the weld, and the marker line on the cable side of the probe to align the  $x=0$  position with the beginning of the area to scan.



Figure 8. Scan position  $x=0$  aligned with the marker line on the probe side

- III) Start the acquisition.
- IV) Acquire data by moving the probe along the weld following the direction indicated by the arrow on the top of the probe.
- V) Stop the acquisition.

**Note1: The total scan length can be changed in Setup → Scan.**

**Note2: Always Null the probe before performing an acquisition.**

### FILLET WELD

- I) Null the probe in the air.
- II) Set the angle of the adjustable module (This can be done before step I).
- III) Place the guiding wheels on the edge of the weld, near the bottom toe.

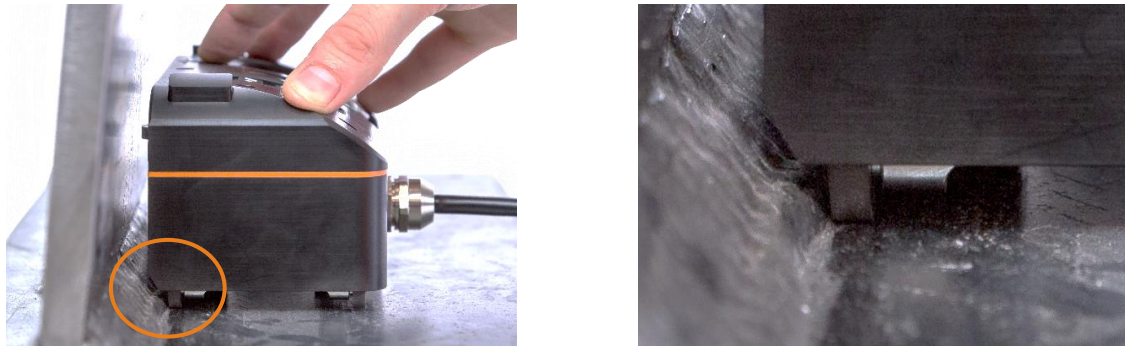

Figure 9. Probe guiding wheels leaning against weld toe

- IV) Press the side wheel adjustment buttons.

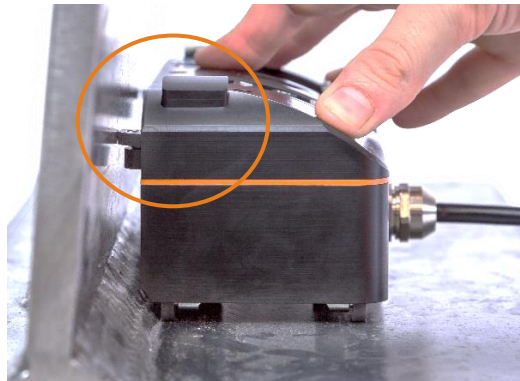

Figure 10. Pressing the side wheel adjustment buttons will trigger the mechanism

- V) Align the marker line on the probe with the beginning of the area to scan.



Figure 11. Scan position  $X=0$  aligned with the marker line on the fillet weld probe

- VI) Start the acquisition.  
 VII) Acquire data by moving the probe along the weld.  
 VIII) Stop the acquisition.

**Note: To perform a full inspection, a second pass is carried out on the wall by turning the probe and carrying out steps I to VII again.**

## ANALYSIS

The analysis is performed in three simple steps: user material calibration, detection and sizing.

**Note: The Sharck BW and FW probes are designed to detect both axial and transverse cracks but only axial ones can be sized. Transverse cracking would need to be scanned axially to be fully assessed.**

### USER MATERIAL CALIBRATION

To compensate for the magnetic permeability of the inspected material, a "user material calibration" should always be performed before analyzing data. This will help with the detection of defects and will ensure the accuracy of the depth sizing.

- I) Open the C-scan cursor as large as possible in the middle of the C-scan. To compensate properly, it is very important that every channel contains more data from clean material than from apparent defects within the width of the horizontal cursor (see Figure 13).
- II) On the Dp-Raw Lissajous, verify that you are on a real channel and not an interpolated channel. If you are on an interpolated channel, move the cursor up and down until the channel name appear on the screen.

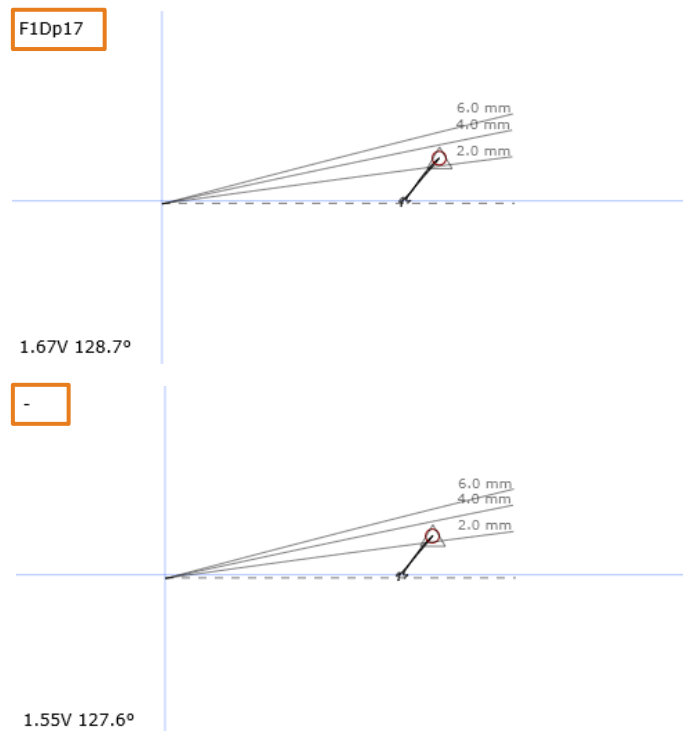

Figure 12. Identification of a real channel. On top, the channel F1Dp07. Below, an interpolated channel, identified as "-"

- III) In the Sharck menu, click the  UserMaterial button.

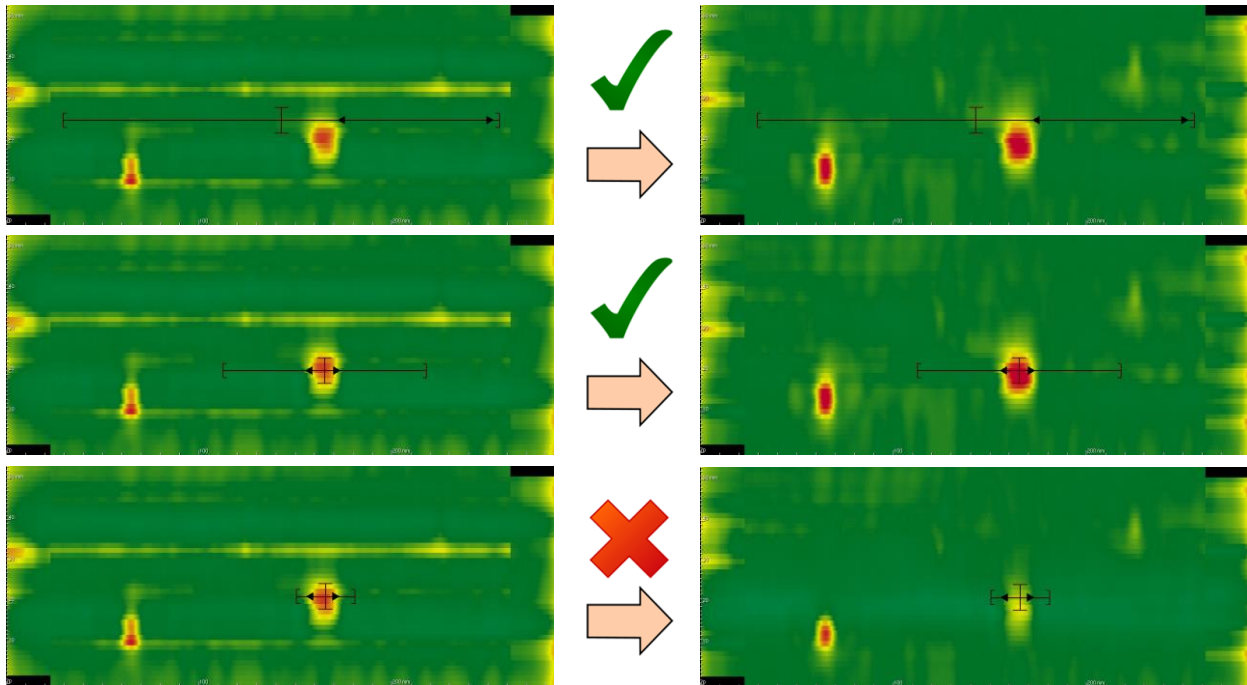

Figure 13. Top: Good user material calibration, with the C-scan cursor widely opened; Middle: Good user material calibration, cursor contains only one specific crack, but opened wide enough (at least three times the length of the crack) providing a local averaging; Bottom: Bad user material calibration, cursor too closed around the crack signal. The user material is not well measured because there is not enough safe material information in it, averaging mostly calculated on the crack signal.

## DETECTION OF AXIAL CRACKS

The detection of axial cracks must be done with both Dp-Proc and Lg C-scans. The Dp-Proc C-scan detect a crack along its entire length, while the Lg C-scan shows its ends.

An indication is considered as an axial crack when it presents these criteria:

- Positive vertical signal (yellow/orange/red) in the Dp-Proc C-scan.
- Blue and red dots in the Lg C-scan. Note that the blue dot is always to the left (first end) of the red dot (last end). If the red dot is to the left of the blue dot, it is not an axial crack (can be linked to a transverse crack or a geometrical indication).
- Correlation between the two C-scans: The blue and red dots must be at the beginning and end of the yellow/orange/red signal.

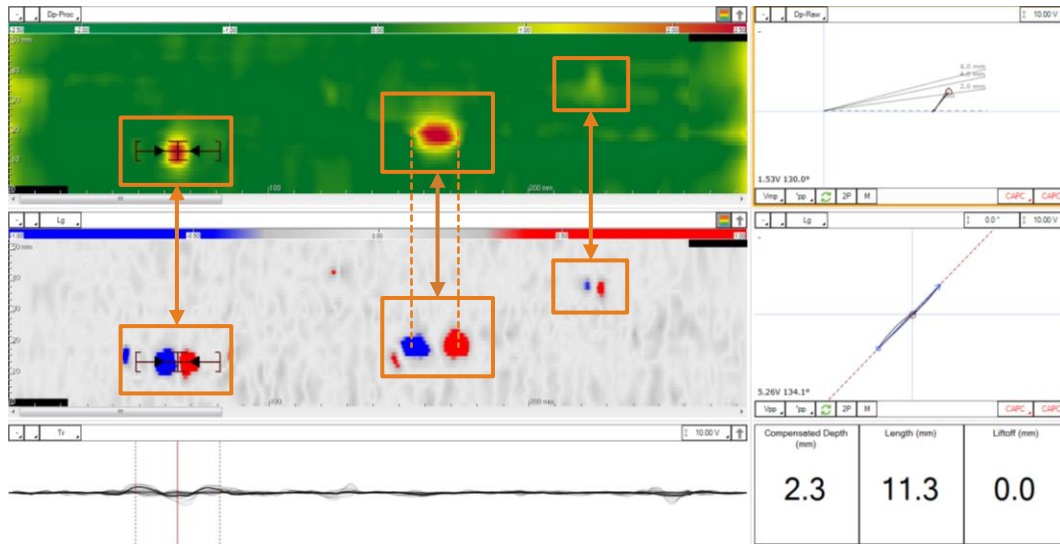

Figure 14. Detection of axial cracks. 3 cracks detected in this example (2 deep and 1 shallow)

On the DP-Proc C-scan, the green color represents the base material (amplitude close to 0.00 V). Crack-like defects are associated to a positive signal that is proportional to their depth (increasing order of crack depth: yellow, orange, bright red, dark red).

The color palette is a visual threshold directly related to the depth of the cracks. To enhance the contrast of the cracks, the color scale can be lowered manually. However, this will also enhance the noise caused by permeability variations, weld geometry, or other surface conditions.

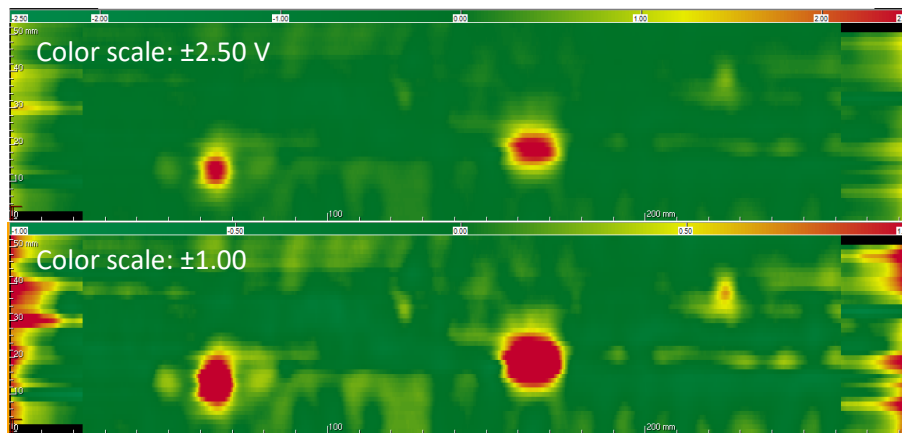
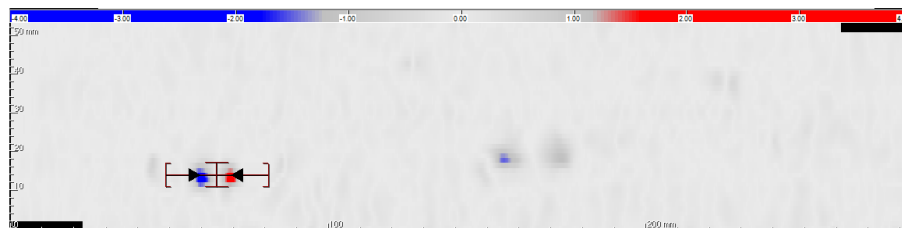

Figure 15. Same cracks displayed with 2 different color scales in Dp-Proc C-scan

In previous version of Magnifi the Lg C-scan is not compensated for lift-off. When lift-off is detected, it is recommended to reduce the scale of Lg C-scan color palette to help with the detection.



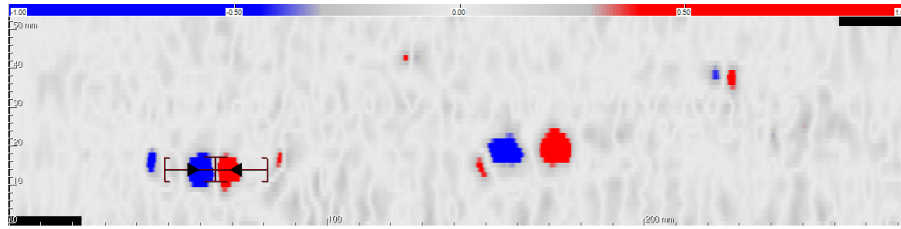

Figure 16. Same cracks displayed with 2 different color scales in Lg C-scan

## DEPTH SIZING AND REPORTING OF AXIAL CRACKS

### Sizing information

During the analysis of a data file, the sizing of axial cracks is shown in the lower right corner of the screen. This information is updated in real time as the cursor is moved in the C-scan views.

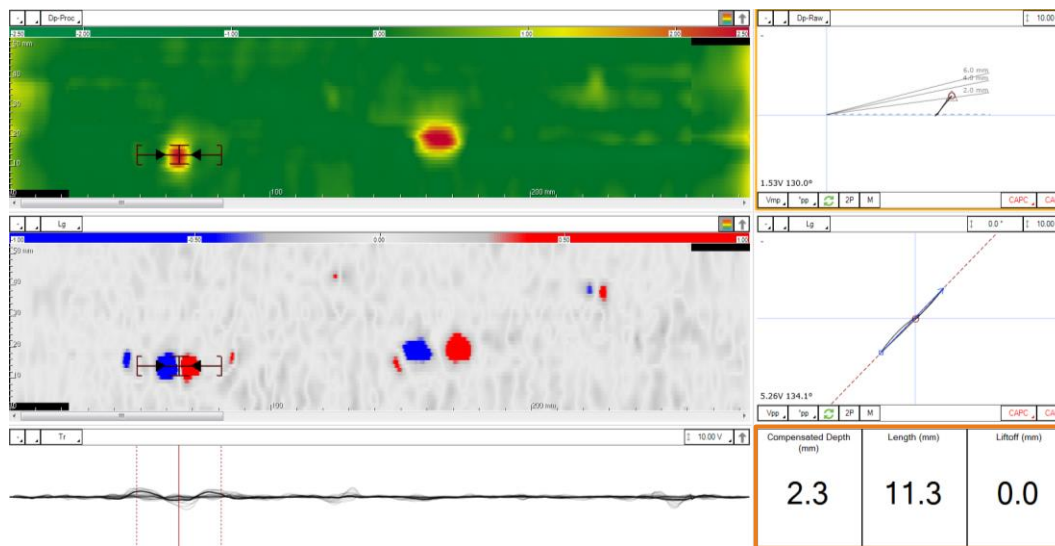

Figure 17. Magnifi automatically maximise the cursor position and measure the depth of crack. Sometimes, there could be several blue and red dots closed to each other. The black arrows on both Dp-Proc and Lg C-scans show which blue and red dots are used for the crack length sizing. This can be adjusted if necessary by the user.

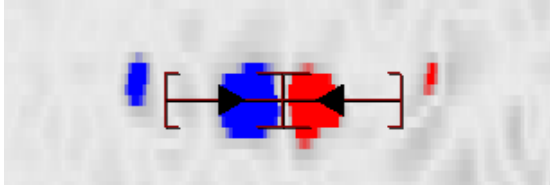

Figure 18. Length arrows on the Lg C-scan

Local user material calibration:

To improve the depth sizing of an axial crack, it is recommended to perform a local user material adjustment (close to the indication) before reporting it.

- I) Click close to the crack in the Dp-Proc or Lg C-scan to center the cursors on the crack.
- II) Open the cursors around three times the length of the defect.

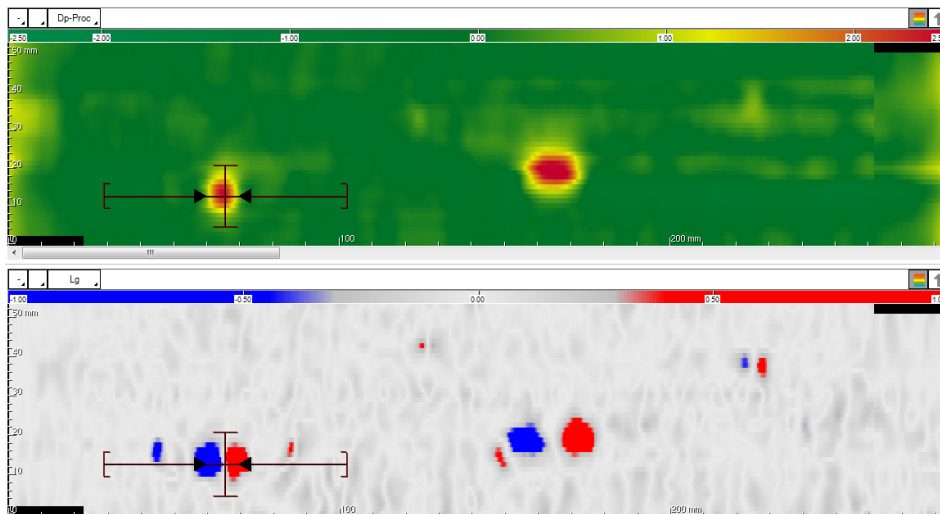

Figure 19. Step Position and size of the cursors on a potential axial crack

- III) Verify that the user material calibration has been done properly around the defect (see Figure 20).

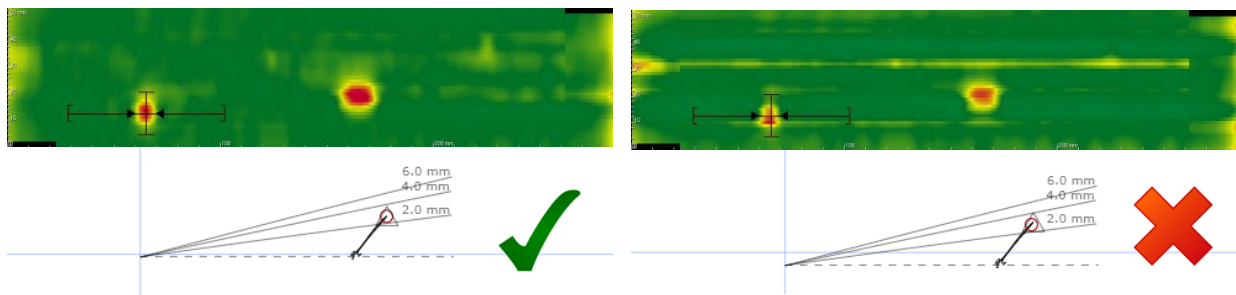



Figure 20. Correct and incorrect user material calibration

**Note:** When correctly applied the background of the Dp-proc C-scan is green around the defect, and the dashed line in the Lissajous is close to the horizontal centreline. When not applied correctly, two yellow stripes are seen around the crack signal, and the dashed line in the Lissajous is far from the horizontal centreline.

- IV) If the user material calibration is not correct, perform a local material calibration by clicking the  **UserMaterial** button without moving the cursors.

Precision sizing and entry report

- l) Use the indication code buttons in the lower right corner of the Lissajous window (for example “CRK” or “SCC”) to add the automatic analysis tool inside the region of interest. If the option “Take a screenshot with report entry” is checked in the backstage, a screenshot will be taken at this point.

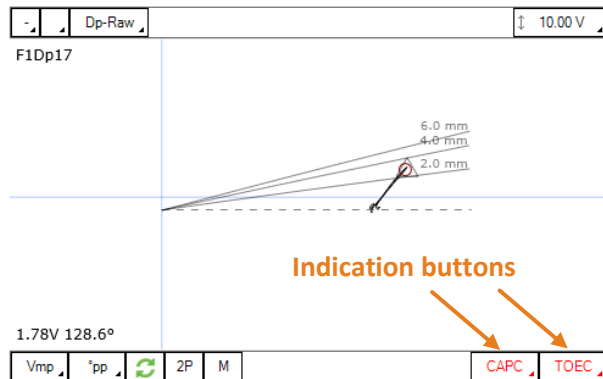



Figure 21. Add indication buttons. The indication code of the button can be changed by clicking the small arrow at the lower right corner of the button

In the backstage of Magnifi, make sure the selected Table Profile in the Report options is Sharck Array. With this option, the report will include the measured depth, position and local lift-off.

This will trigger two events (if the “Defect Tuning”  option is selected):

Data within the cursors are scanned and the cursors get centered over the indication giving the deepest sizing.

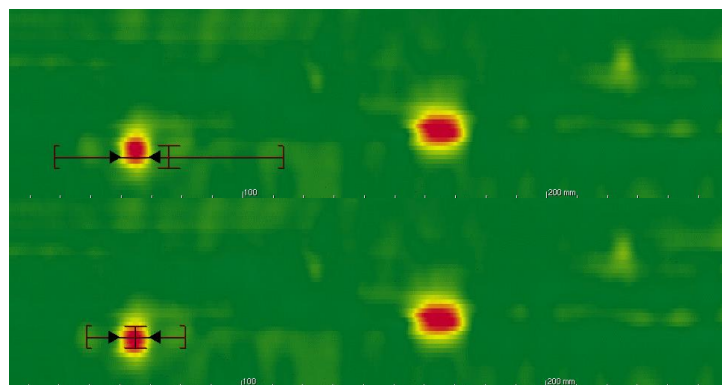

Figure 22. Cursor positioning prior to (top) and after (bottom) clicking the indication button  
The TECA Tune Calculations window opens.



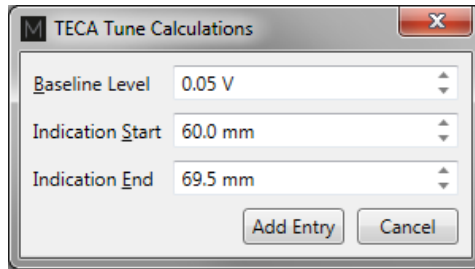

Figure 23. TECA Tune Calculations window

- II) In most cases, the automatic process will give the optimized results, so no adjustment is needed in the TECA Tune Calculations windows. However, in the rare cases that the automatic process is not optimal, this window gives the user the choice to adjust some parameters, making sure the sizing is accurate. If such a case happens, the user can manually adjust:

- i) The baseline level, if it seems incorrect on the Lissajous. This can occur if there is a lot of background noise or if there is a rapid change of material properties near the crack or if the cursors are set too tight around the crack signal.

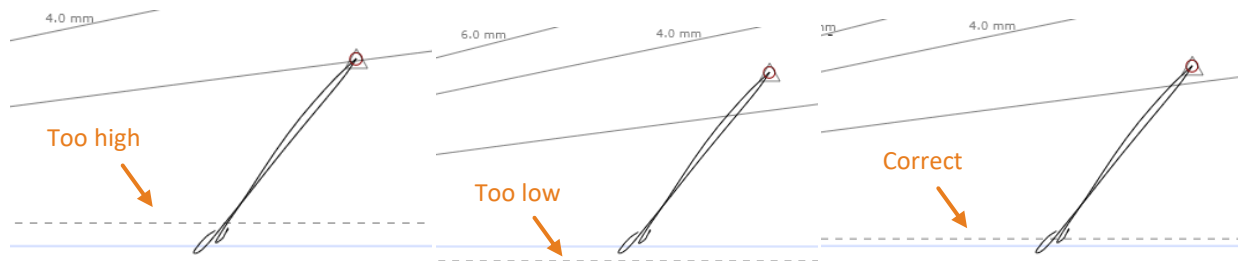

Figure 24. Baseline level (dashed line). Set too high (1), too low (2), or correctly (3)

- ii) The start and/or end of a crack. The start/stop position might not be correct for intermittent cracking but also cracking occurring at the edge of the scan. The gray arrows on the C-scans will move as these parameters are adjusted (Figure 18).
- l) Click “Add Entry” to add the analyzed indication in the report or click “Cancel” to close the TECA Tune Calculations windows without adding the indication to the report.

**Note1:** If a datafile contains no defect indication, you can click



**Note2:** To add or remove indication codes, go to Setup → Indication.

## DETECTION OF TRANSVERSE CRACKS

The detection of transverse crack can rapidly be done using the TR strip chart, at the bottom of the default layout. Note that the TR strip chart is not compensated for the lift-off. If lift-off is detected, it is recommended to reduce the scale of the strip chart to avoid missing a defect.

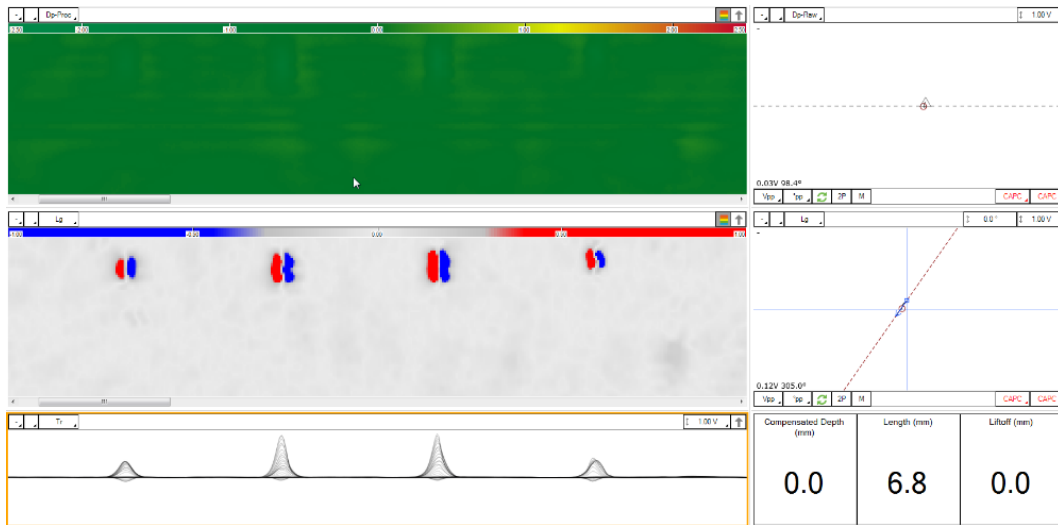

Figure 25. Detection of transverse cracks (four in this example)

If you wish to see the approximated length of a transverse crack and its position, select the TR C-scan.

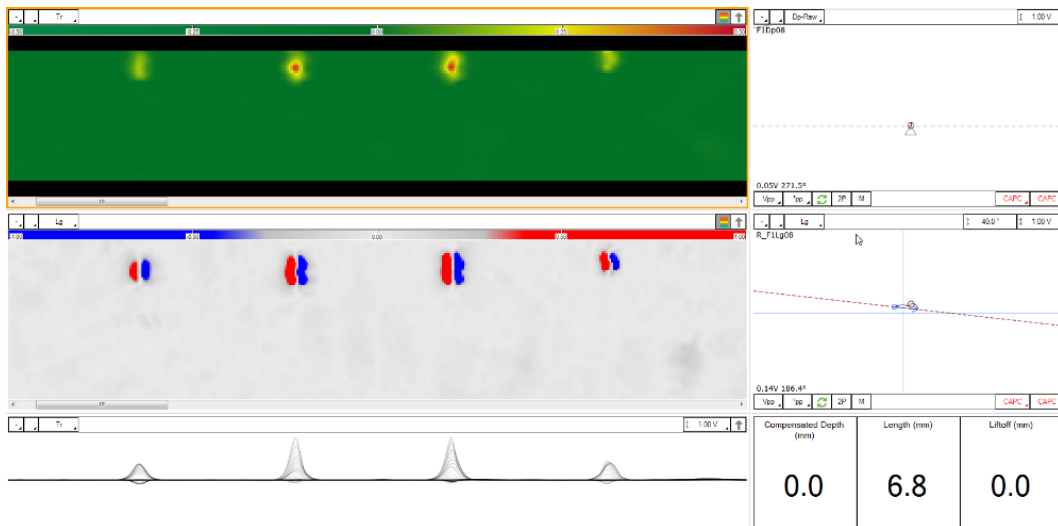

Figure 26. Transverse cracks visible on TR C-scan

If a transverse crack is detected an additional scan along the defect will be necessary (if the geometry enables it) to obtain sizing information.

## MAINTENANCE

---

### PROTECTION FROM ABRASIVE SURFACES

If the component to be inspected is abrasive or rough, it is recommended to protect the probe with a tape (polyolefin, Teflon or other non-conductive abrasion resistant material). If the sample has a flat surface, the tape can be put directly on the probe fingers. The lift-off compensation will ensure a good measurement even if not all fingers are in contact with the surface, as long as the lift-off is 3 mm (0.12 in) at most.



Figure 27. Protective tape applied on probe active area

If the weld cap is too high, causing a lift-off superior to 3 mm (0.12 in), it is best to put it on the sample, to allow the probe sensors to be in contact with the surface.



Figure 28. Protective tape applied directly on weld

## BUTT WELD PROBE MAINTENANCE

When used on dirty surfaces, dust can accumulate on the encoder wheel and between the fingers. To clean the encoder, unscrew it with a small flathead screwdriver from the probe housing and clean it with a soft cloth or air spray. To clean the fingers, disassemble the removable frame to loosen the fingers and remove the dust between them with a soft cloth or air spray. Make sure to reassemble all the parts prior

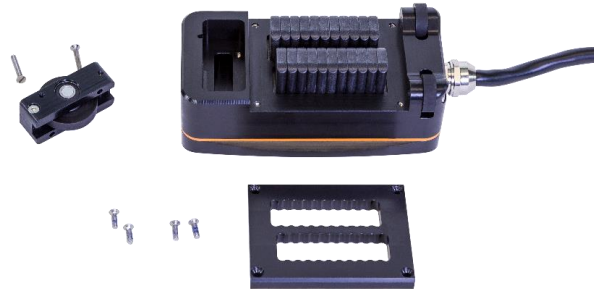

to carrying out further inspection.

Figure 29. The encoder and the removable frame can be dismantled to clean the probe. Supporting wheels can also be remove if necessary



Figure 30. With the 1st frame removed, the fingers are looser and can therefore be separated for an easy cleaning

## FILLET WELD PROBE MAINTENANCE

To clean the fingers of the fillet weld probe, follow the same procedure as the one for the butt weld probe. Since the encoder is spring-loaded, it is not possible to remove it from the probe housing.

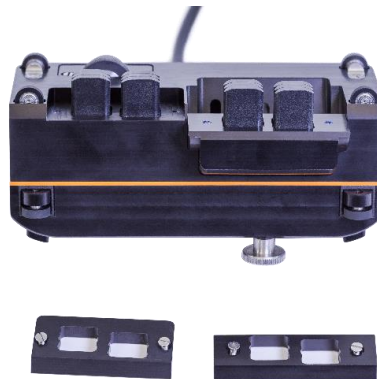

Figure 31. Both modules have a removable frame to help the fingers cleaning

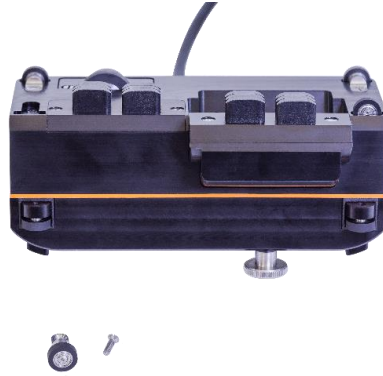

Figure 32. Guiding and supporting wheels can also be unscrewed if it is necessary to clean them

## ENCODER CALIBRATION

---

If the encoder resolution included in the Magnifi setup is different from its real resolution, the data in the C-scan will be slightly distorted (misalignment of indications and zigzag shapes, see Figure 33 below). The length measurement and defect positioning can be affected.

In such a case, a simple calibration can be performed to apply a correction factor to the encoder resolution:

Start an acquisition.

Move the probe in a straight line and on a flat surface and stop the acquisition.

**Note1: A longer travel distance will lead to a more precise calibration.**

**Note2: It is not required to scan a metallic surface for this calibration.**

Measure precisely the traveled distance.

In the *Calibration* menu, click on the *Encoder*  calibration button.

Enter the measured traveled distance and click Enter.

Click *Calibrate* and click *OK*. The correction factor is now applied to the setup configuration.

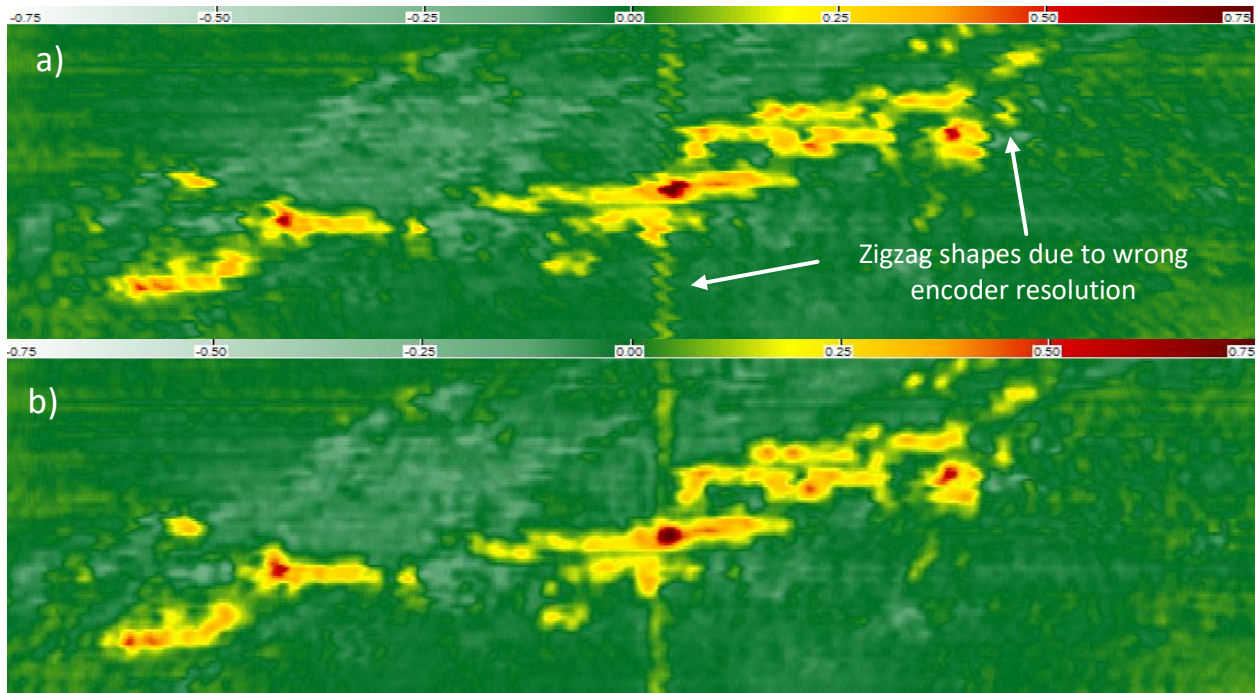

Figure 33. a) Before encoder calibration (small error on the encoder's resolution); b) after encoder calibration

# Sharck™ Pencil G2 Application Guide

## PROBE DESCRIPTION

---



Figure 34 : Sharck Pencil G2 models. Straight (ST) (left), Right Angle (RA) (middle), and Toothbrush (TB) (right).

## MATERIAL COMPATIBILITY

---

The User Mat calibration that will be discussed later in this User guide is mainly useful to compensate for permeability changes which may occur during scans, either along a same part being inspected or simply, between alloys having different properties. Permeability changes affect signal amplitude for a given flaw, this is then the reason why there is a need to compensate for it, assuring accurate depth sizing on each individual crack. The Sharck probes were primarily designed for the assessment of surface breaking cracks in carbon steel material and welds. Those can also be used to derivatives to a certain extend.

### Carbon steels (most of construction steels)

- Reliable detection.
- Reliable depth sizing.

### Alloy steels

- Reliable detection
- Possible underestimation of depth sizing (specifically Nickel based one).

***Note: A dedicated sizing matrix, hence setup file can be produced for specific alloys providing a sample with EDM notches is made available to Eddyfi.***

### High strength low alloy (HSLA) steel



- Reliable detection.
- Reliable depth sizing.

***Note: Forged steels can be carbon steels, alloy steels or HSLA steels. Same capabilities as mentioned above.***



## SETUP

---

- I) Make sure to use Magnifi® 4.3 or Magnifi® GO 1.4 (or a more recent version).
- II) Click *Open setup*  and select the setup corresponding to the probe in the Default Master List.
- III) Connect the pencil probe to the Ectane® 41-pin connector or to the Reddy® 19-pin connector.
- IV) For Ectane® only: connect  the instrument to Magnifi®.

## DATA MANAGEMENT

---

This section suggests a convenient way to manage and save automatically large amounts of data files during an inspection. The following steps can be done in advance in Magnifi (or Magnifi GO), before getting to the inspection site.

In the backstage of Magnifi, in the *Inspection* menu, select a project folder and an inspection folder



In the *Acquisition* menu, select the *Prefix* filename option.

Click *Create New List* .

Select the prefix for the data file list, the number of files in the list, the index for the first data file and the index increment between each file. The example below shows an example of data file list based on the following parameters:

### Selected parameters:

<b>Prefix:</b>	TECA
<b>Number of elements:</b>	4
<b>Element start number:</b>	10
<b>Element increment:</b>	2

### Resulting data file list :

Prefix	Index
TECA	010
TECA	012
TECA	014
TECA	016

Click *Create*

In the frontstage, in the *Layout* tab, make sure the *Data* button is checked. The data file list will be displayed on the left side of the screen.

At the bottom of the data file list, click *Acquisition preferences* , and check the following two options:

Automatic file recording

Automatic Next on Stop Acquisition





When an acquisition is stopped, these two options allow to automatically save the data file and select the next one in the list. The user can then start the next acquisition, without any other action required.

Once the setup parameters and preferences are settled and the probe has been calibrated (see section 4), uncheck *Setup Mode*  in the *Home* tab.





In the data file list, select the first file to be acquired. The inspection can then begin.

A few more information about data management in Magnifi and Magnifi GO:

- The small icon beside each data file indicates its current state:

Icon	Definition
	The data file was acquired and saved, but has not been analyzed yet
	The data file was acquired, saved and analyzed, and it was reported as being defect-free
	The data file was acquired, saved and analyzed, and defects have been reported
	The data file has not been acquired yet (empty file)
	The data file is tagged for further review

For more information on data analysis, refer to section 0 of this user guide.

- At any time during the inspection, the user can click *Add data*  or *Delete data*  at the bottom of the data file list. Data files added with this button will keep the same prefix, and their index will be incremented by the number selected in the index menu . To create data files with a new prefix, go back to the backstage and click *Create New List*.
- To re-scan a data file that has already been acquired and saved, right-click the data file (or hold the Reddy's touchscreen) and click *Re-scan*. To choose whether the original data file should be kept or erased, select the corresponding option in *Acquisition preferences* .

## LAYOUT

1. Dp-Proc strip chart: Visualisation of axial cracks with material permeability and lift-off compensations.
  - Used to localize axial cracks indications quickly, in combination with Lg strip chart
2. Lg strip chart: Visualisation of axial cracks ends
  - Used to localize axial crack indications quickly, in combination with Dp-Proc strip chart, and size the axial cracks length
3. Dp-Raw Lissajous: Raw impedance signal within the cursor of the strip charts.
  - Used for depth measurement of axial cracks
4. Compensated Depth: Depth measurement of the axial crack, up to 7 mm, with compensation for lift-off and permeability.
5. Length: Length approximation of the axial crack
  - The length approximation is based on the manual scan speed. To be accurate, the scan must be done at exactly 50 mm/s.
6. Lift-off: Local lift-off measurement, up to 4 mm
7. Lg Lissajous: Signal of the Lg channel within the cursors of the strip chart.



Figure 35 : Acquisition and analysis layout

## PROBE CALIBRATION

---

I) Place the probe in the air, away from any metallic surface, then click on Null 

II) In the Sharck menu, click *Calibration* 

III) Keeping the probe in the air, click on

IV) Put the probe in the middle of the aluminum plate supplied for calibration purposes

**Note1: Place the probe in the center of the Aluminium plate with the tip flat on the surface**

**Note2: Ensure the Aluminium plate is placed away from any conductive material prior to performing the calibration.**

V) Click on

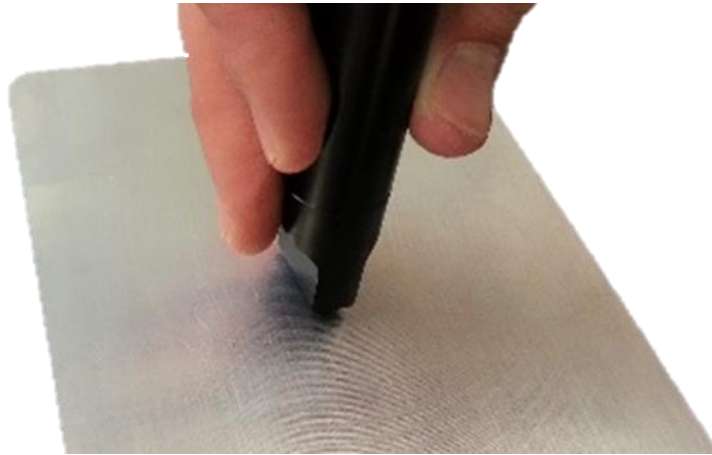

Figure 36: Sharck pencil probe on the aluminum plate

VI) Place the probe on the material to be inspected.

VII) Click on  and move the probe on the material.

**Note: During this calibration step, keep the probe flat on the surface, in the HAZ.**

VIII) Click on .

IX) Close the Sharck calibration window.

## ACQUISITION

---

- I) Null the probe in the air.
- II) Place the probe on the weld.

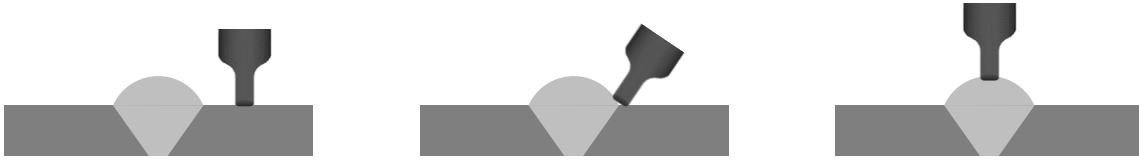

Figure 37 : Probe tip position on the weld. Flat on in the HAZ (left), with an angle on the toe (center), and flat of the top of the weld (right).

- III) Start the acquisition.
- IV) Scan the weld with the probe so that the long side of the tip of the probe is parallel to the weld, in the direction of the arrow featured on the pencil's casing.

**Note:** Scanning speed should be approximately 50 mm/sec (2 in/sec)

**Note:** It is recommended to do two scans on the toe. The first scan with the tip flat on the surface, in the HAZ, leaning on the toe of the weld. The second scan with the tip at mid-angle between the weld and the HAZ.

- V) Stop the acquisition

**Note1:** Always Null the probe before performing an acquisition.

**Note2:** To detect transverse cracks on the top of the weld turn the probe 90°

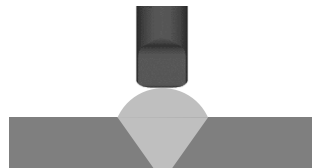

Figure 38 : Probe tip position for the detection of transverse cracks.

## ANALYSIS

The analysis is performed in three simple steps: user material calibration, detection, and sizing.

### USER MATERIAL CALIBRATION

To compensate for the magnetic permeability of the inspected material, a "global user material calibration" should always be performed before analyzing data, to help with the detection of defects. A "local user material calibration" will ensure the accuracy of the depth sizing (see section 0).

I) For a global calibration, open the strip chart cursor as large as possible in the middle of the Dp-Proc strip chart. To compensate properly, it is very important that the signal within the cursors contains more data from clean material than from apparent defects or lift-off.

II) In the Sharck menu, click the  UserMaterial button.



Figure 39 : Top: Good user material calibration, with the C-scan cursor widely opened; Middle: Good user material calibration, cursor contains only one specific crack, but opened wide enough (at least three times the length of the crack) providing a local averaging; Bottom: Bad user material calibration, cursor too closed around the crack signal.

The user material is not well measured because there is not enough safe material information in it, averaging mostly calculated on the crack signal.

### DETECTION OF AXIAL CRACKS

The detection of axial cracks is made using both the Dp-Proc and the Lg strip charts. The Dp-Proc strip chart shows the depth of the crack, while the Lg strip chart shows its beginning and end. To be certain that an axial crack is present, it must meet these criteria:

- Positive peak in the Dp-Proc strip chart.

- Negative and positive peaks in the Lg strip chart. Note that the negative peak is always to the left of the positive peak. If the positive peak is to the left of the negative peak, it is not an axial crack (can be linked to a transverse crack or a geometrical indication).
- Correlation between the two strip charts : The negative and positive peaks in the Lg strip chart must be at the beginning and end of the positive peak in the Dp-Proc strip chart

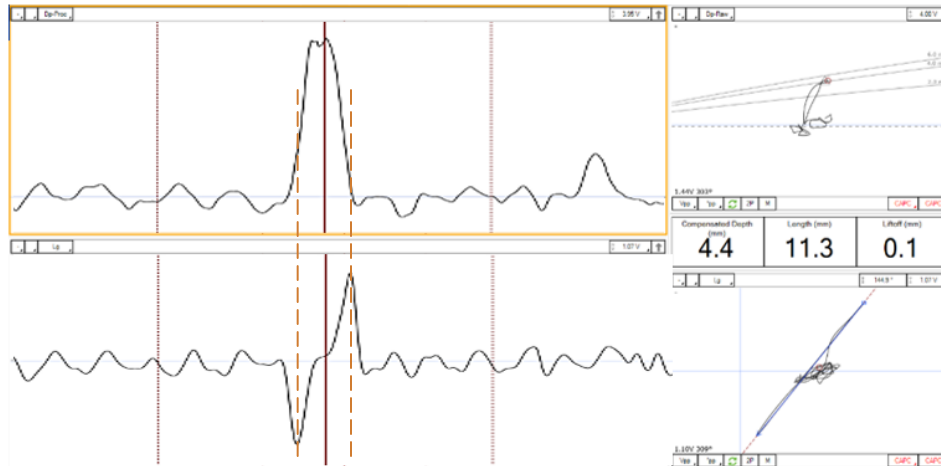

Figure 40: Detection of axial cracks. The ends of the crack are correlated on both strip charts.

## DEPTH SIZING AND REPORTING OF AXIAL CRACKS

### SIZING INFORMATION

During the analysis of a data file, the sizing of axial cracks is shown between the two Lissajous. This information is updated in real time as the cursor is moved in the strip charts.

Compensated Depth (mm)	Length (mm)	Liftoff (mm)
4.4	11.3	0.1

Figure 41 : Example of sizing information displayed in the infodields. In this example, the compensated depth of the crack is 4.4 mm, the length is 11.3 mm and the lift-off is 0.1 mm.

### LOCAL USER MATERIAL CALIBRATION

To improve the depth sizing of an axial crack, it is recommended to perform a local user material adjustment (on or close to the indication) before reporting it.

III) Click on the crack in the Dp-Proc or Lg strip chart to center the cursors on the crack.

IV) Open the cursors to at about three times the length of the defect.

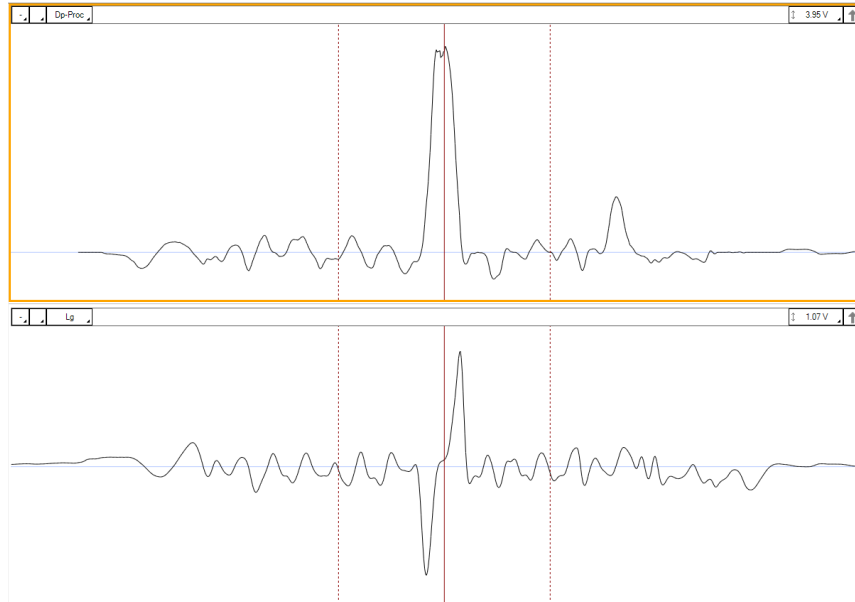

Figure 42 : Position and size of the cursors on a potential axial crack

V) Verify that the user material calibration has been done properly around the defect.

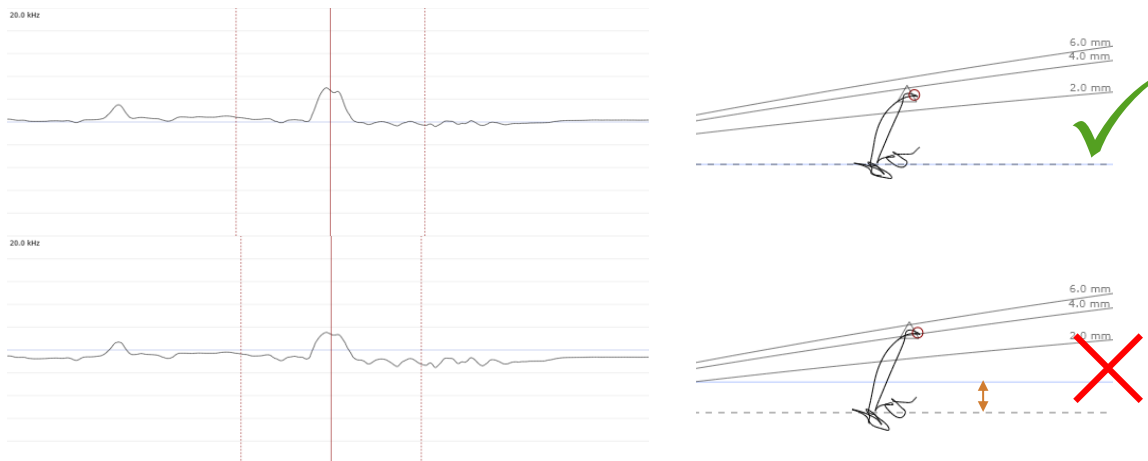



Figure 43 : Good vs bad user material calibration. On the top (good calibration), the dashed line in the Lissajous is near the horizontal null mark line. On the right (bad calibration), the dashed line in the Lissajous is far from the horizontal null mark line.

VI) If the user material calibration is not correct, perform a local material calibration by clicking the  **UserMaterial** button without moving the cursors.

### PRECISION SIZING AND ENTRY REPORT

VII) Click on one of the indication buttons in the lower right corner of the Lissajous (“CAPC” written in red in Figure 44). This will open the TECA Tune Calculations window (Figure 45)



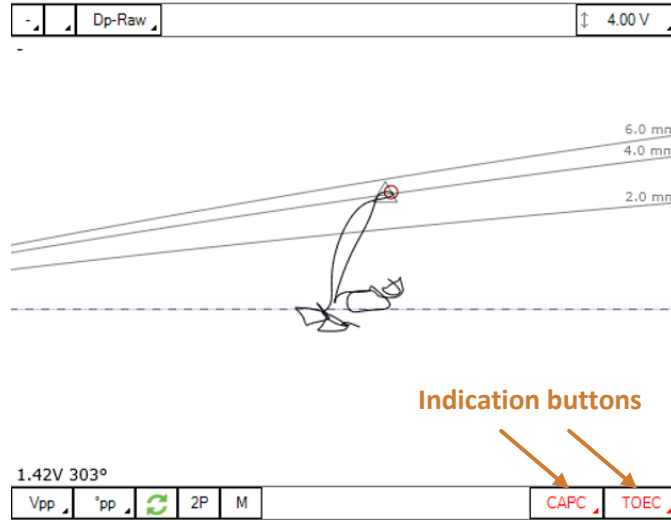

Figure 44: Indication buttons in the Lissajous window

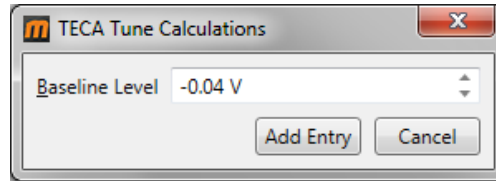

Figure 45: TECA Tune Calculations window

VIII) In most cases, the automatic process will give the optimized results, so no adjustment is needed in the TECA Tune Calculations windows. However, in the rare cases that the automatic process is not optimal, this window gives the user the choice to adjust some parameters, making sure the sizing is accurate. If the baseline seems incorrect on the Lissajous, the user can manually adjust it. This can occur if there is a lot of background noise or if there is a rapid change of material properties near the crack or if the cursors are set too tight around the crack signal.

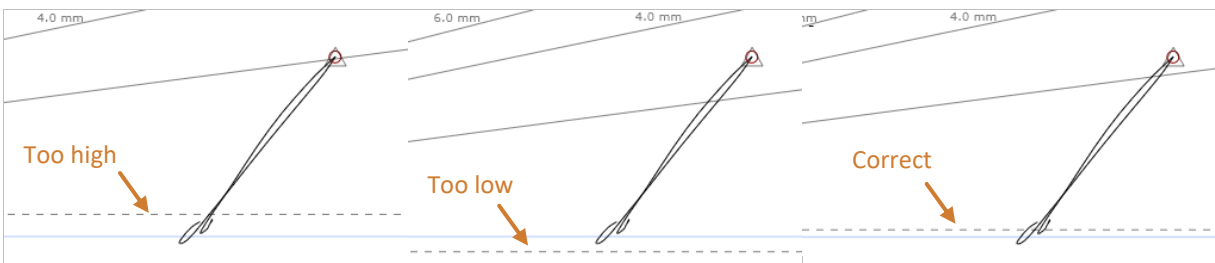

Figure 46 : The baseline level (dashed line). It can be too high (left), too low (middle), or spot on (right).

IX) Click on “Add Entry” to add the analyzed indication in the report or click on “Cancel” to close the TECA Tune Calculations windows without adding indication to the report.

**Note1:** If a datafile contains no defect indication, you can click



**Note2:** To add or remove indication codes, go to Setup → Indication.

## MAINTENANCE

---

If the component to be inspected is abrasive or rough, it is recommended to protect the probe with a tape (polyolefin, Teflon or other non-conductive abrasion resistant material). However, **make sure to remove the tape before a full calibration** (section 0)

# Sharck-HR Application Guide

## PROBE DESCRIPTION

---

### SHARCK HR

1. Scan direction
2. Buttons for curvature adjustment
3. Paired encoded wheels
4. Flexible shoe with protective 0.125 mm (4.9 thou) polyolefin tape
5. Beginning of coverage mark (Y = 0.0 mm (0.0 in))
6. End of coverage mark (Y = 71.2 mm (2.80 in))



Figure 47. Sharck HR features

## KEY CHARACTERISTICS

Type of defect	Short and shallow cracking (longitudinal to scan axis)
Conformability	Conforms to curvature From 254 mm (10 in)
Coverage	71 mm (2.8 in)
Channels requirements	64
Resolution	1 to 2 mm (0.04 to 0.08 in) axially 3 mm (0.12 in) circumferentially
Detection capabilities	Axial only From 1.5 x 0.25 mm (0.06 x 0.01 in)
Sizing capabilities	Axial only From 6 x 0.25 mm (0.06 x 0.01 in) Up to 3 mm (0.12 in) deep Up to 2 mm (0.08 in) Lift-off
Temperature	100 degC (212 F)
Maximum probe speed	Up to 600 mm/s (24 in/s)

## MATERIAL COMPATIBILITY

---

The User Mat calibration that will be discussed later in this User guide is mainly useful to compensate for permeability changes which may occur during scans, either along a same part being inspected or simply, between alloys having different properties. Permeability changes affect signal amplitude for a given flaw, this is then the reason why there is a need to compensate for it, assuring accurate depth sizing on each individual crack. The Sharck HR probe was primarily designed for the assessment of surface breaking cracks in alloy steels.



### Alloy steels

- Reliable detection.
- Reliable length and depth sizing.

**Note: It can currently be used on Grade B, X42, X46, X52, X56 and X60.**

## MAGNIFI SETUP

---

- I) Make sure to use Magnifi 4.4 or Magnifi GO 1.5 (or a more recent version).
- II) If the probe is being used for the first time, click *Open setup*  and select the file SHARCK-HR-1048-071 from the Default Master List.
- III) Connect the 160-pin ECA probe connector to an Ectane® or Reddy®.
- IV) Connect the 18-pin encoder to the Ectane I/O connector, or the 12-pin encoder to the Reddy I/O connector.
- V) For Ectane only: connect the instrument to Magnifi .

## DATA MANAGEMENT

---

This section suggests a convenient way to manage and save automatically large amounts of datafiles during an inspection. The following steps can be done in advance in Magnifi (or Magnifi GO), before getting to the inspection site.

X) In the backstage of Magnifi, in the *Inspection* menu, select a project folder and an inspection folder .

XI) In the *Acquisition* menu, select the *Prefix* filename option.

XII) Click *Create New List*.

XIII) Select the prefix for the datafile list, the number of files in the list, the index for the first datafile and the index increment between each file. The example below shows an example of datafile list based on the following parameters: **Selected parameters:**

<b>Resulting datafile list:Prefix:</b>	SCC
<b>Number of elements:</b>	4
<b>Element start number:</b>	10
<b>Element increment:</b>	2

<b>Prefix</b>	<b>Index</b>
SCC	010
SCC	012
SCC	014
SCC	016

XIV) Click *Create*

XV) In the frontstage, in the *Layout* menu, make sure the *Data* button is checked. The datafile list will be displayed on the left side of the screen.

XVI) At the bottom of the datafile list, click *Acquisition preferences* , and check the following two options:

- i) Automatic file recording
- ii) Automatic Next on Stop Acquisition





When an acquisition is stopped, these two options allow to automatically save the datafile and select the next one in the list. The user can then start the next acquisition, without any other action required.

XVII) Once the setup parameters and preferences are settled and the probe has been calibrated (see section 4), uncheck *Setup Mode*  in the *Home* menu.





XVIII) In the datafile list, select the first file to be acquired. The inspection can then begin.

A few more information about data management in Magnifi and Magnifi GO:

- The small icon beside each datafile indicates its current state:

Icon	Definition
	The datafile was acquired and saved, but has not been analyzed yet
	The datafile was acquired, saved and analyzed, and it was reported as being defect-free
	The datafile was acquired, saved and analyzed, and defects have been reported
	The datafile has not been acquired yet (empty file)
	The datafile is tagged for further review

For more information on data analysis, refer to section 7 of this user guide.

- At any time during the inspection, the user can click *Add data*  or *Delete data*  at the bottom of the datafile list. Datafiles added with this button will keep the same prefix, and their index will be incremented by the number selected in the index menu . To create datafiles with a new prefix, go back to the backstage and click *Create New List*.
- To re-scan a datafile that has already been acquired and saved, right-click on the datafile (or hold the Reddy's touchscreen) and click *Re-scan*. To choose whether the original datafile should be kept or erased, select the corresponding option in *Acquisition preferences* .



## LAYOUT

1. Processed C-Scan: Visualization of the cracks with material permeability and lift-off compensations. Each horizontal line corresponds to a channel of the probe  
→ Used to localize crack indications quickly
2. Processed strip chart: Superimposed strip charts, each of them representing 1 of the probe's 64 channels  
→ Used to display the profile of the cracks, measure their length and localize the strongest indications (deepest cracks)
3. Lissajous window: Raw impedance signal of the channels underneath the cursor in the C-scan  
→ Used for depth measurement of axial cracks.
4. Compensated depth: Depth measurement of axial cracks, up to 3 mm (0.12 in), with compensation for lift-off and permeability
5. Lift-off: Local lift-off measurement, up to 2 mm (0.08 in)

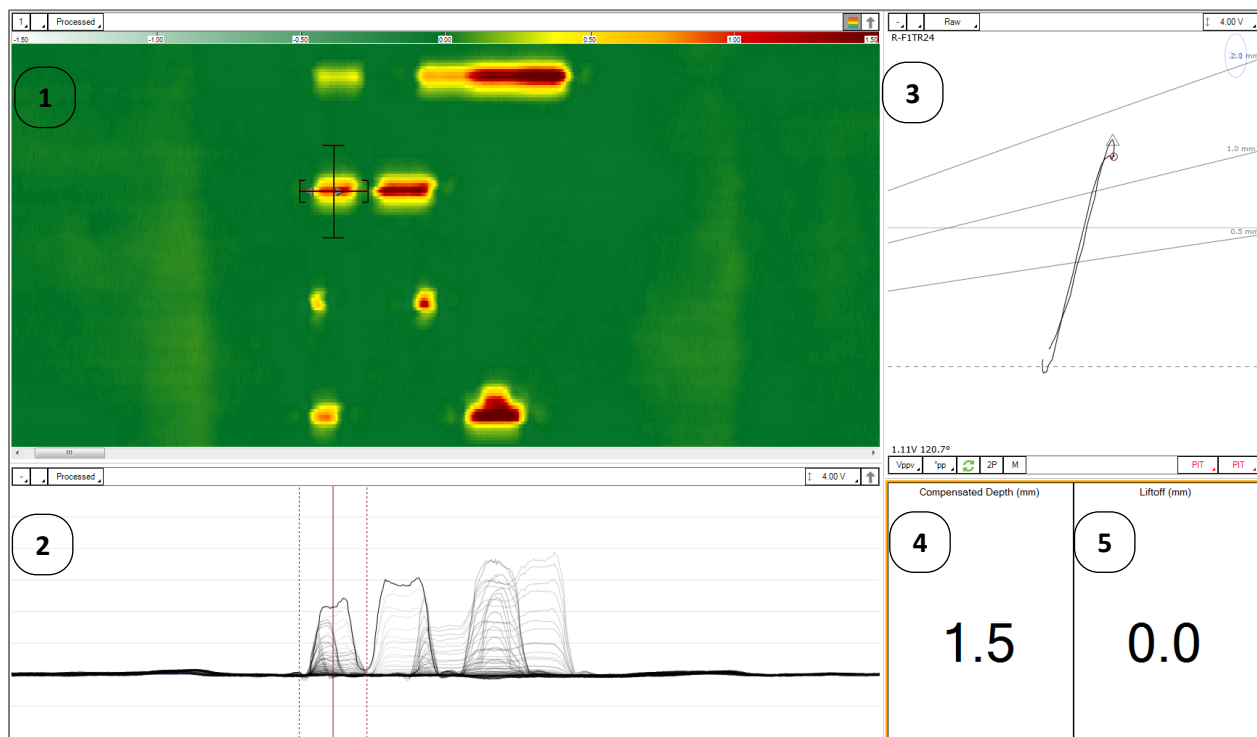

Figure 48. Sharck HR acquisition and analysis layout

**Note: To change the settings of any of these windows, select it and go to the Current View menu.**

•

## PROBE CALIBRATION

---

The following calibration should be performed before beginning a new inspection:



- I) Hold the probe in the air, and press on the 2 buttons for curvature adjustment to make sure the flexible shoe is completely flattened.
- II) Hold the probe in the air, away from any metallic surface, and click *Null* .
- III) In the *Sharck* menu, click *Calibration* .
- IV) Keep the probe in the air and click
- V) Put the probe in the middle of the aluminum plate supplied with the probe and apply pressure to ensure that all four wheels are in close contact with the surface. Click .
- VI) Press the 2 side buttons to lock the spring-load mechanism. Then, hold the probe on the pipe's surface by applying a very light pressure on it. This will curve the shoe to the OD of the pipe.
- VII) Release the buttons. If the mechanism seems to block, try the last step again by applying a lighter pressure on the probe. Make sure the shoe is now curved correctly.
- VIII) Put the probe on the carbon steel surface and apply pressure to ensure that all four wheels are in close contact with the surface. Click .
- IX) Click .
- X) Close the Sharck calibration window.



Figure 49. The three probe calibration steps

## ACQUISITION

---

- I) Use the buttons on the probe to adjust the curvature of the flexible shoe according to the surface to inspect (see steps VI and VII in section 6).
- II) Null the probe in air.
- III) Align the front surface of the probe with the beginning of the area to scan.



Figure 50. Scan position  $x=0$  aligned with the front of the probe

- IV) Start the acquisition.
- V) Move the probe in the direction indicated by the arrow on the casing. Apply enough pressure on the probe during the acquisition to make sure that all wheels are rolling at all time. Data acquisition will be disabled if the encoded wheels are not rolling.
- VI) Stop the acquisition.

**Note: The total scan length can be changed in Setup → Scan.**

## ANALYSIS

---

The analysis is performed in three simple steps: user material calibration, detection and sizing.

**Note: The Sharck HR is designed specifically to detect and measure the depth of cracks oriented along the axis of the pipe. Other crack orientations can be detected, but the accuracy of their depth measurement will not be accurate.**

### USER MATERIAL CALIBRATION

To compensate for the magnetic permeability of the inspected material, a “user material calibration” should always be performed before analyzing data. This will help with the detection of defects and with the accuracy of the depth sizing.

**Note: If a C-scan contains multiple SCC colonies, a user material calibration should be performed locally for each colony, in order to always compensate for the local permeability.**

- I) Place the C-scan cursor on a “clean” area of the C-scan (i.e. area without any SCC, corrosion or major permeability variations). Open the horizontal cursor in a way to include only clean material on all 64 channels of the C-scan. If possible, this clean area should be located near the SCC indications to analyze.

Alternatively, place the cursor directly on the SCC indications to analyze, and extend the width of the cursor to include clean material on both sides of the SCC.

The data points inside the horizontal cursor will be used to evaluate the material permeability on every individual channel. To compensate properly, it is very important that every channel contains more data from clean material than from SCC within the width of the horizontal cursor.

Figure 13 on next page shows a few examples of correct and incorrect C-scan cursor positioning for the user material calibration.

- II) In the *Sharck* menu, click on  UserMaterial

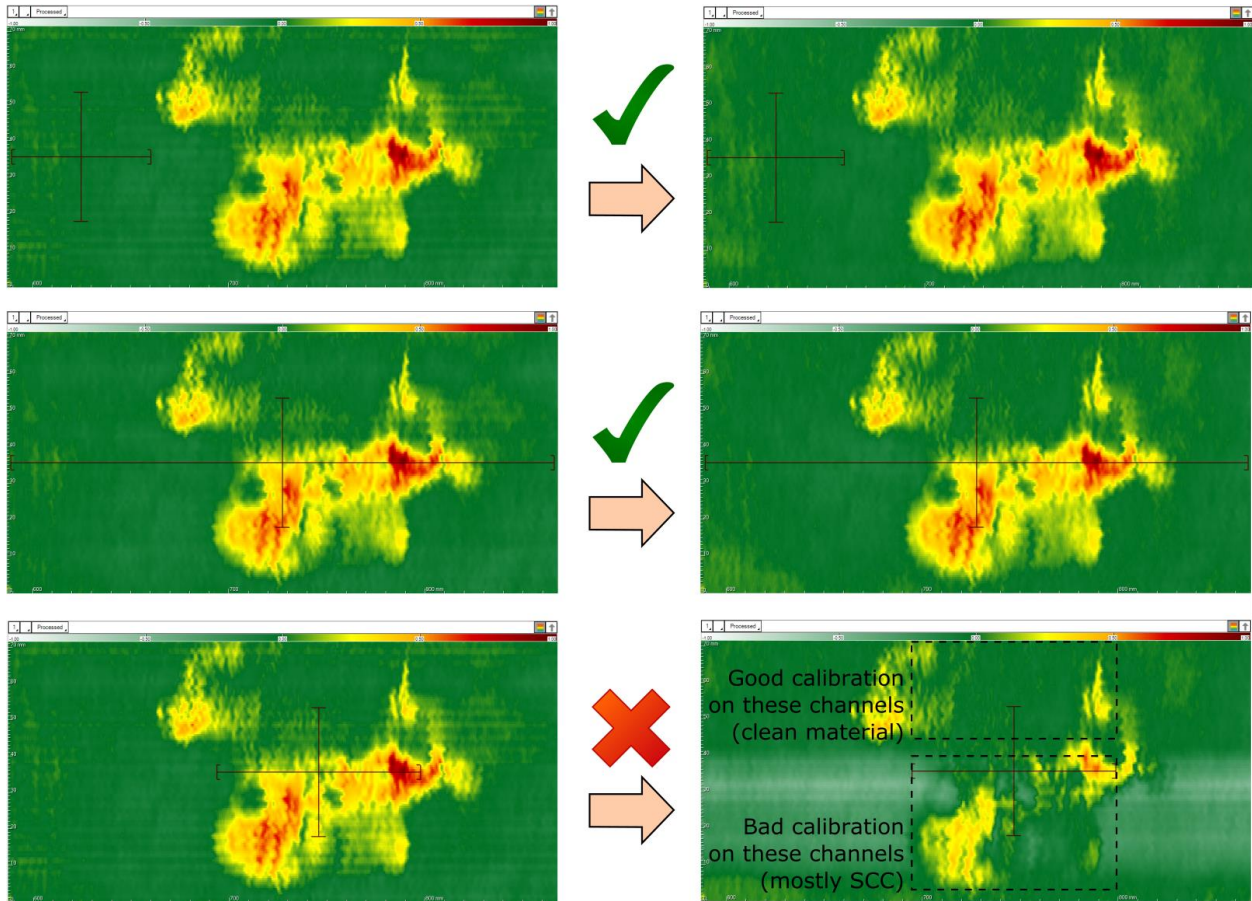



Figure 51. Top: Good user material calibration, with the C-scan cursor located in a clean, defect-free area directly besides a SCC colony; Middle: Good user material calibration, with the cursor located on the SCC colony, and opened wide enough to include more clean material than SCC indications on all channels; Bottom: Bad user material calibration. The top half of the C-scan is calibrated correctly because the area within the width of the horizontal cursor is mostly clean, but the bottom half of the C-scan contains mostly SCC indications within this width. The white color in these channels is an indication of a bad user material calibration.

In the rare situations where SCC indications cover most of the C-scan, it may be impossible to place the cursor in a way to have clean material on all channels. Figure 52 on next page shows an example of such a situation.

In these cases, the ideal solution is to re-scan the area, this time including clean material before or after the SCC colonies. If re-scanning is not possible, the other alternative is to perform multiple partial user material calibrations:

III) Adjust the vertical cursor to cover only the channels on which to perform the partial user material calibration. Adjust the horizontal cursor to cover clean material on these channels.

IV) In the *Calibration* menu, select *System* . Then click *C-scan*, *CursorUserMat*, *Click-on* , and *Calibrate*.

- V) Repeat steps I and II in a different area, until the user material calibration has been performed on all channels:

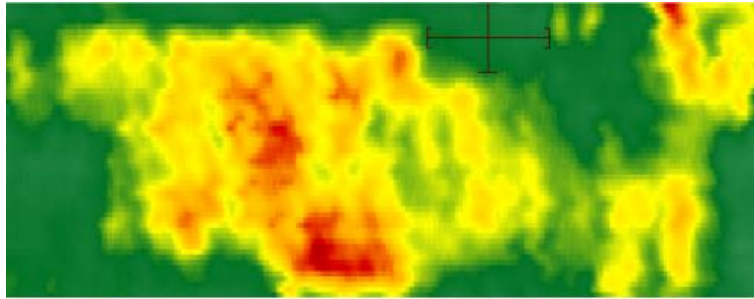

Partial user material calibration #1: clean material on channels 1 through 17

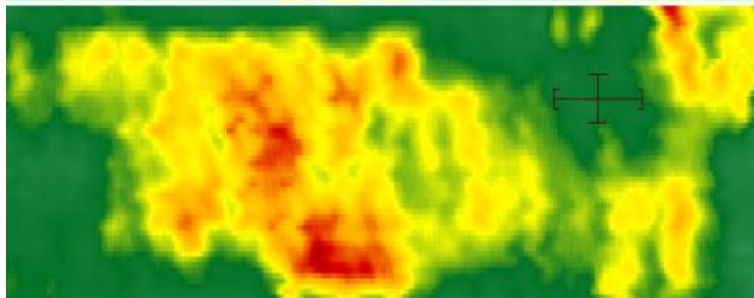

Partial user material calibration #2: clean material on channels 18 through 26

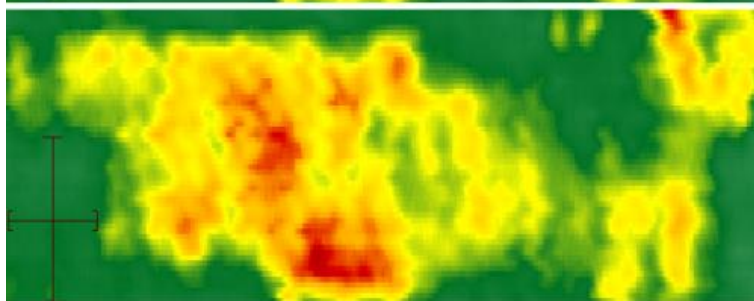

Partial user material calibration #3: clean material on channels 27 through 64

Figure 52. Example of data without any area with clean material on all channels. Three partial user material calibrations are required to calibrate all channels.

## DETECTION OF AXIAL CRACKS

The detection of cracks is done mainly using the Processed C-Scan, in which the lift-off is automatically compensated.

The green color represents the base material (amplitude close to 0.00 V). Cracks and crack-like defects are associated to a positive signal that is proportional to their depth (in increasing order of crack depth: yellow, orange, bright red, dark red). Areas of corrosion with missing material are generally associated to a negative signal and displayed in white in the C-scan:

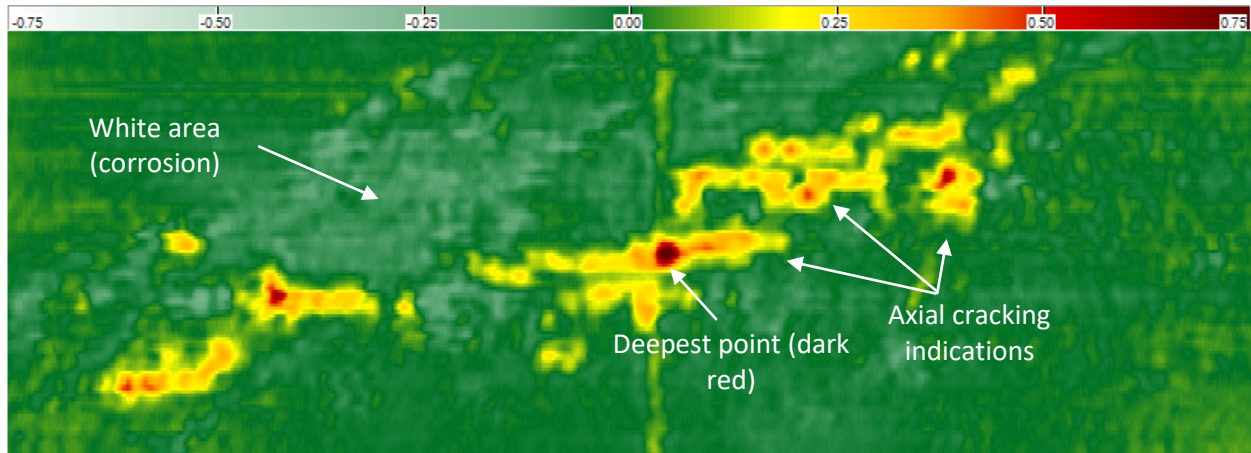

Figure 53. Processed C-scan used for the detection of cracks

The color palette is a visual threshold directly related to the depth of the cracks. To enhance the contrast of the cracks, the color scale can be lowered manually. However, this will also enhance the noise caused by corrosion, permeability variations or other surface conditions. For most typical cases of stress corrosion cracking (SCC), the color scale should be adjusted between  $\pm 0.50$  V and  $\pm 2.00$  V for optimal results.

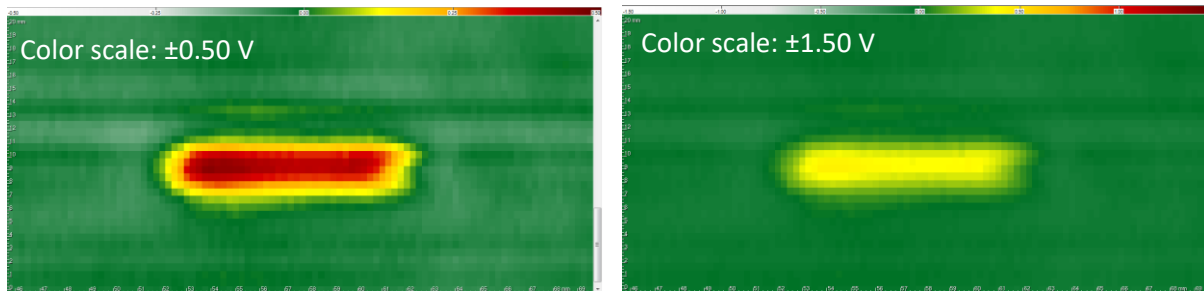

Figure 54. Same crack displayed with 2 different color scales

The strip chart below the C-scan represents a cross-section (side-view) of the C-scan. It can be used to visualize the depth profile of the cracks. The options to display a single channel, all channels inside the C-scan vertical cursor, or all 64 channels are available in the *Current View* menu.

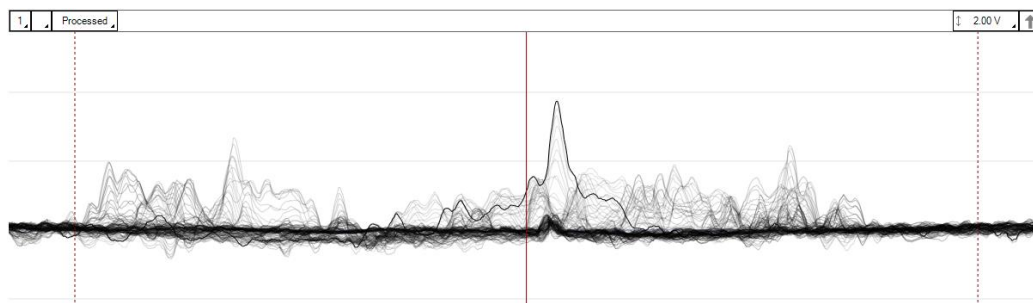
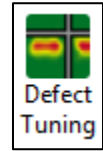

Figure 55. Strip chart window displaying all 64 channels from the C-scan in Figure 14

## DEPTH SIZING AND REPORTING OF AXIAL CRACKS

Magnifi contains a powerful analysis tool that allows the automatic localization and depth sizing of the deepest crack within a given SCC colony. To facilitate its use, make sure the *Defect Tuning* button in the *Sharck* menu is left unchecked.



The software uses the area delimited by the C-scan cursor as the region of interest for the detection of the deepest crack indication. Simply by changing the position and size of the cursor, the user can choose to localize and measure the deepest indication either in an entire SCC colony, or to focus only on a sub-area of a colony. The position of the deepest crack within the cursor area is automatically indicated by a double triangle ▶◀:

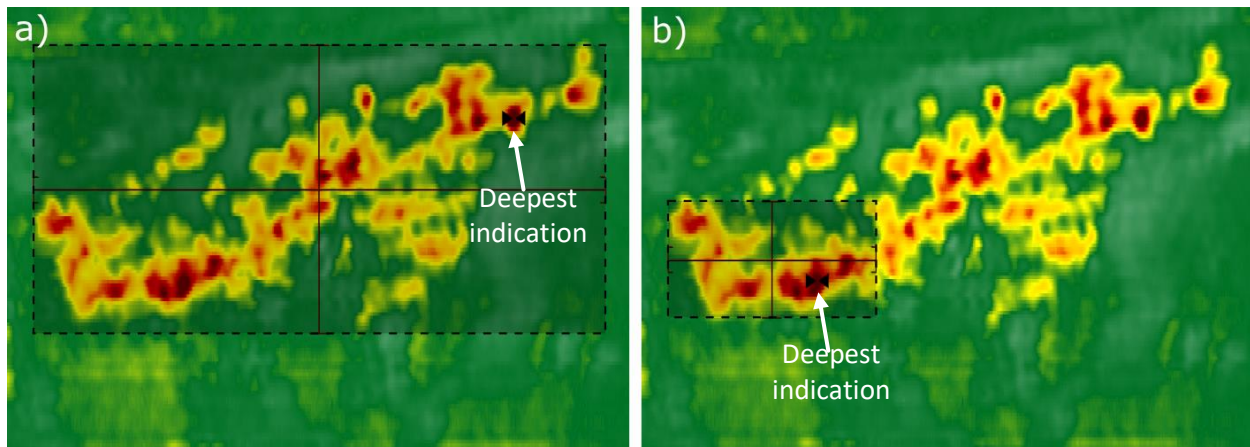

Figure 56. Magnifi will localize and measure the depth of the deepest crack within a) the entire SCC colony; b) only the lower-left section of the colony. For the situation in b), the analysis tool can be used multiple times to localize and measure individually the deepest cracks within the other sub-colonies.

Before analyzing either an entire SCC colony or a smaller sub-colony, Magnifi needs to define a reference baseline in order to measure the maximum signal amplitude within the region of interest and convert it into a depth measurement. This reference baseline is displayed as a horizontal dashed line in the Lissajous and the strip chart windows. It is obtained from the “clean” (i.e. defect free) material surrounding the cracks.

Defining the baseline correctly is key to obtain an accurate depth sizing of the cracks. To achieve this, Magnifi offers two different options:

1) Automatic baseline calculation:

To use this option, go to the *Sharck* menu and make sure the *Lock Baseline* button is left unchecked.

The baseline calculation requires that the horizontal C-scan cursor is opened large enough to include clean material on both sides of the SCC colony. The signal from this clean material forms the “root” of the cracks signal in the Lissajous.

The width of the cursor should be at least twice that of the colony. This will allow Magnifi to define the reference baseline with the data points from the clean surface. If the horizontal cursor is not





opened large enough, Magnifi will use signal from SCC to define the baseline, which will lead to an under-sizing of the crack's depth.

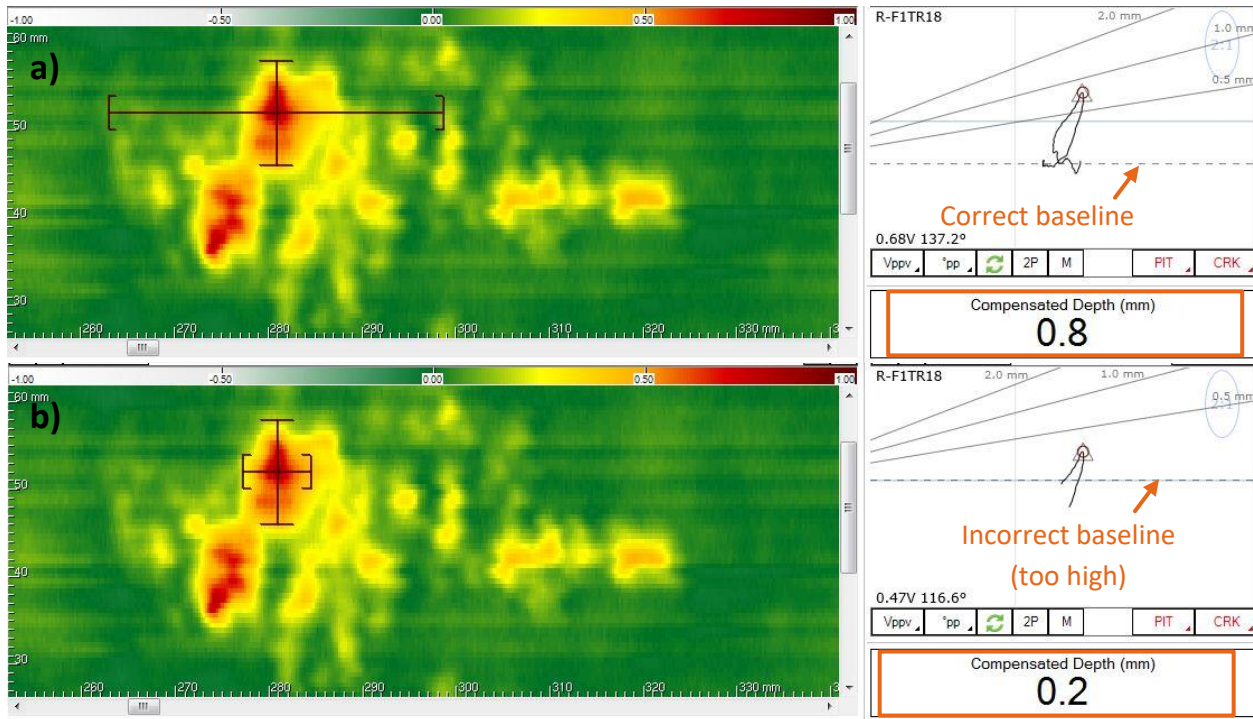
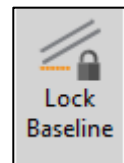

Figure 57. a) The horizontal cursor includes enough clean material on both sides of the SCC indication, allowing a correct baseline calculation and an accurate depth sizing of the crack (0.8 mm (31.5 thou)); b) Horizontal cursor too narrow, leading to an incorrect baseline calculation and major under-sizing of the crack's depth (0.2 mm (7.9 thou)).

## II) Manual baseline adjustment:

To use this option, go to the *Sharck* menu and make sure the *Lock Baseline* button is checked (grayed).

The manual baseline adjustment is particularly useful to analyze large SCC colonies without much clean material surrounding the indications. Locking the baseline ensures that Magnifi never recalculates the baseline: it will stay at the same level in the Lissajous, independantly of the C-scan cursor's position and size. The user is responsible of adjusting it by dragging it manually in the Lissajous window.



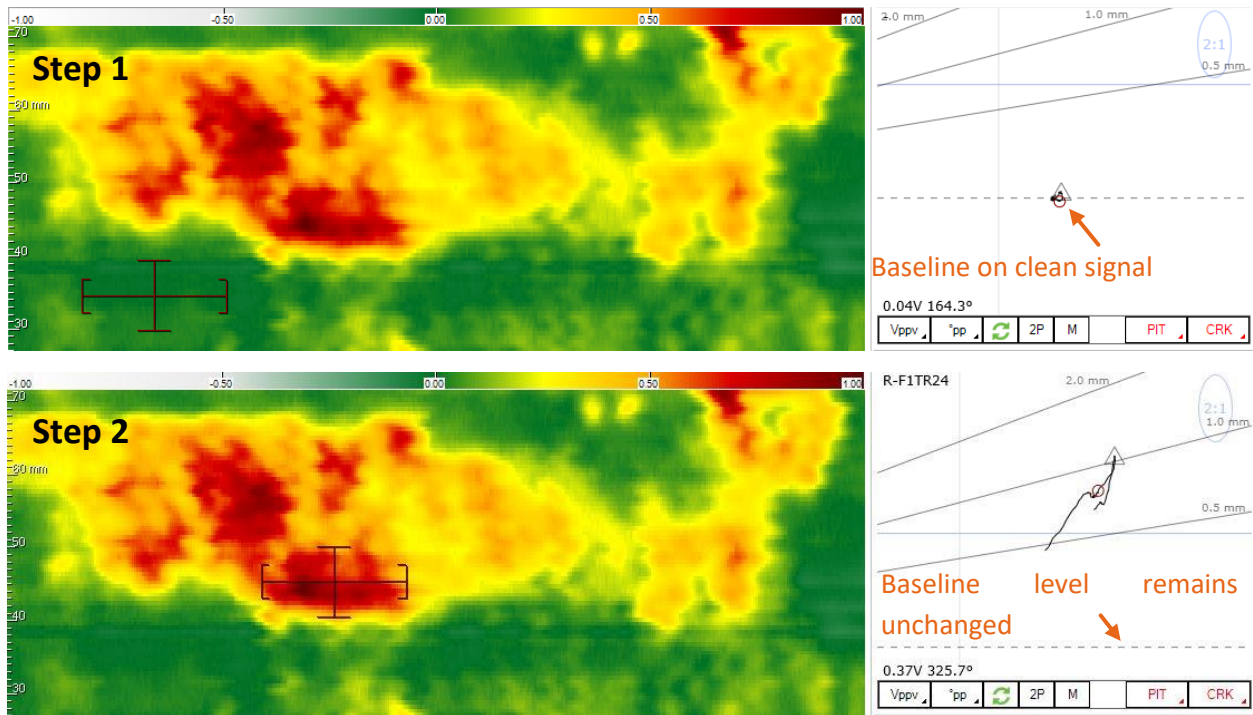

Figure 58. Step one: place the cursor on a clean area and adjust the position of the baseline on the “clean” signal by dragging it in the Lissajous; Step two: move the C-scan cursor on the indication to be measured. The baseline level will remain unchanged and the depth sizing will be accurate as long as the baseline is not moved again.

To the more practiced users, Eddyfi recommends to always keep the baseline locked and adjust it manually before reporting an indication (option II). When analyzing a large area or a large SCC colony, it is important to make sure that the baseline level remains the same within the whole area covered by the C-scan cursor. For that reason, it is recommended to analyze smaller sub-colonies individually, and adjust the baseline manually each time. This will lead to more accurate depth measurements.

Finally, the presence of corrosion or strong variations of permeability can make the baseline more difficult to adjust. In these cases, the stripchart below the C-scan can be of great help:

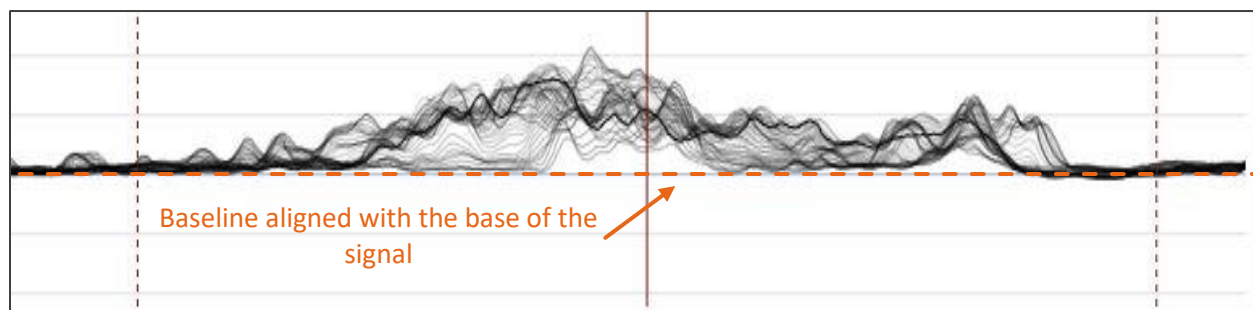

Figure 59. Using the strip chart view can be useful to position the baseline at the right level.

In summary, the procedure to measure the depth of axial cracks and add them to the report goes as follows:

- I) Place the cursor on the SCC indication to be measured, and adjust its size to cover only the region of interest (either an entire SCC colony or a smaller sub-area);

**Note: If a datafile contains no defect indication, you can click**



- II) Make sure the baseline is correctly adjusted (either automatically or manually);

- III) Use the indication code buttons in the lower right corner of the Lissajous window (for example "CRK" or "SCC") to add the automatic analysis tool inside the region of interest. If the option "Take a screenshot with report entry" is checked in the backstage, a screenshot will be taken at this point.



**Note: To add or remove indication codes, go to Setup → Indication.**

In the backstage of Magnifi, make sure the selected *Table Profile* in the Report options is *Sharck Array*. With this option, the report will include the measured depth, position and local lift-off. See below an example of the information reported in the case of an analysis by individual SCC sub-colonies:



Figure 60. Summary table displayed on the first page of the report, containing information about all the defects that were reported in the current inspection. This is usually followed by individual screenshots and information of all the reported defects.

## LENGTH MEASUREMENT OF AXIAL CRACKS

The Sharck HR does not automatically measure the length of the cracks. However, it can be measured manually:

- I) In the C-scan, put the cursor on the axial crack to be measured
- II) In the strip chart, adjust the width of the cursor to the length of the crack's signal
- III) The center position of the cursor (X and Y) is displayed at the bottom of the screen. It corresponds to the position of the crack relatively to the beginning of the scan.
- IV) The aperture of the horizontal cursor ( $\Delta x$ ) is also displayed at the bottom of the screen. It corresponds to the length of the crack.

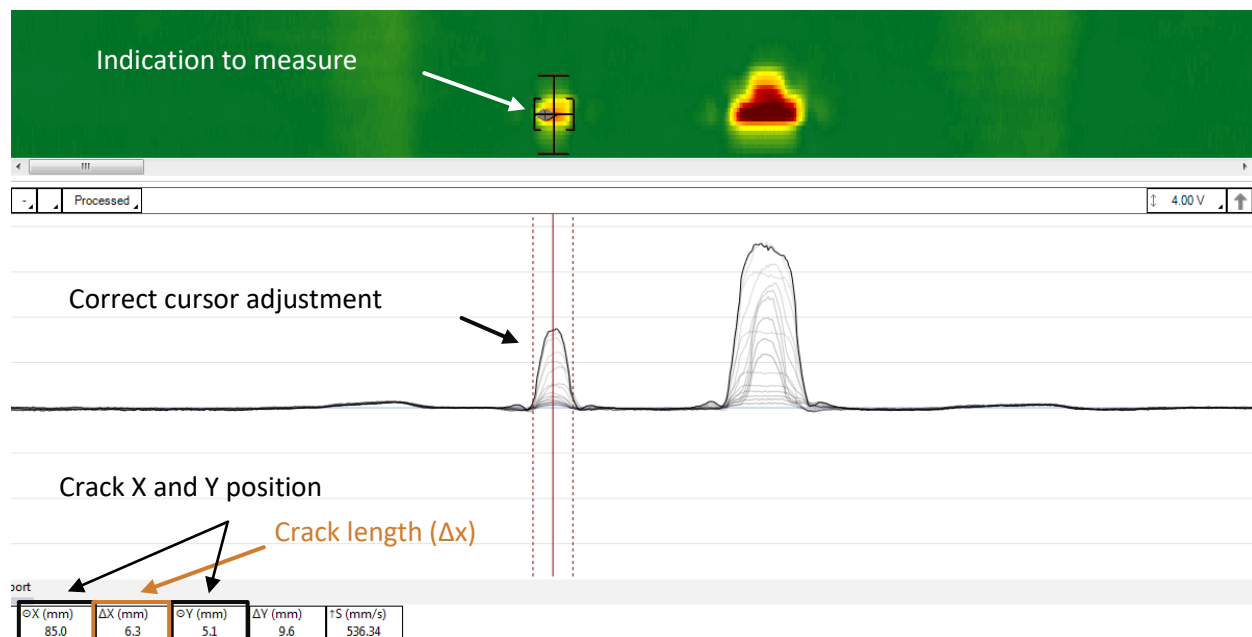

Figure 61. Position and length measurement of an axial crack

In a similar way, the size of SCC colonies can be measured by opening the horizontal and vertical C-scan cursors around it:

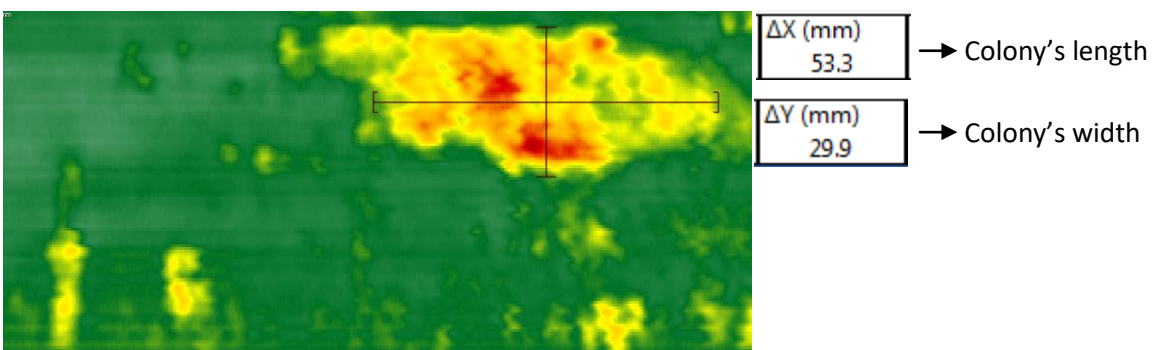

Figure 62. Measurement of a SCC colony

## MAINTENANCE

---

To protect the probe from eventual damage and to ensure an accurate lift-off monitoring, the probe should always be used with a 0.125 mm (4.9 thou) thick polyolefin layer covering its shoe.

When used on very rough surfaces, this protective polyolefin layer can wear out rapidly. Make sure to replace it before the probe gets damaged.

Five replacement layers are provided with the probe. If a different material is used, it should be 0.125 mm (4.9 thou) thick. A layer with a different thickness will lead to inaccurate lift-off measurements, and possibly to signal saturation.

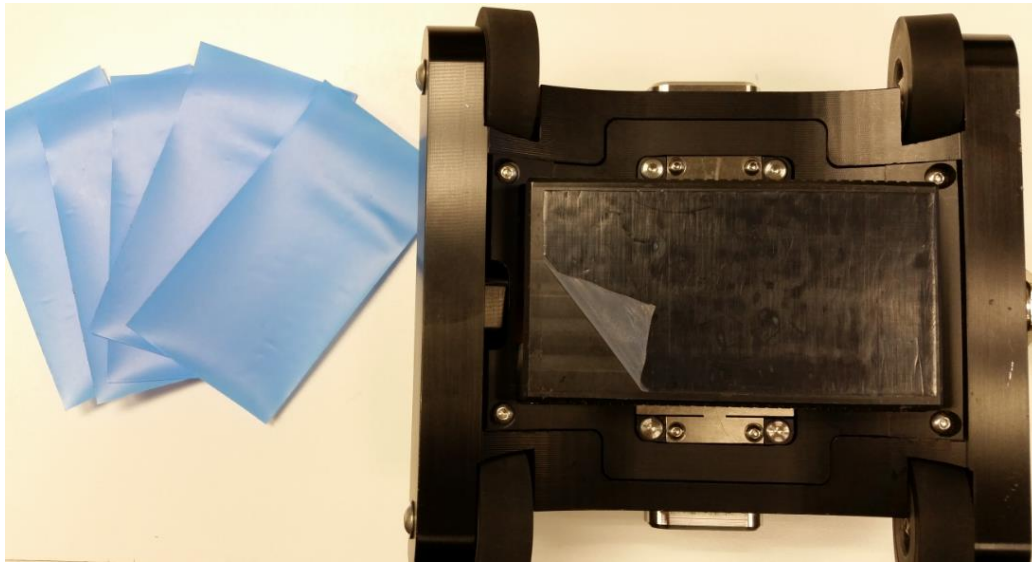

Figure 63. Sharck HR with protective polyolefin layer and 5 spare parts

***Note: When storing the probe, it is recommended to set the probe shoe flat.***

## ENCODER CALIBRATION

If the encoder resolution included in the Magnifi setup is different from its real resolution, the data in the C-scan will be slightly distorted (misalignment of indications and zigzag shapes, see Figure 33 below). The length measurement and defect positioning can be affected.

In such a case, a simple calibration can be performed to apply a correction factor to the encoder resolution:

- I) Start an acquisition.
- II) Move the probe in a straight line and on a flat surface and stop the acquisition.

**Note1: A longer travel distance will lead to a more precise calibration.**

**Note2: It is not required to scan a metallic surface for this calibration.**

- III) Measure precisely the traveled distance.
- IV) In the *Calibration* menu, click on the *Encoder*  calibration button.
- V) Enter the measured traveled distance and click Enter.
- VI) Click *Calibrate* and click *OK*. The correction factor is now applied to the setup configuration.

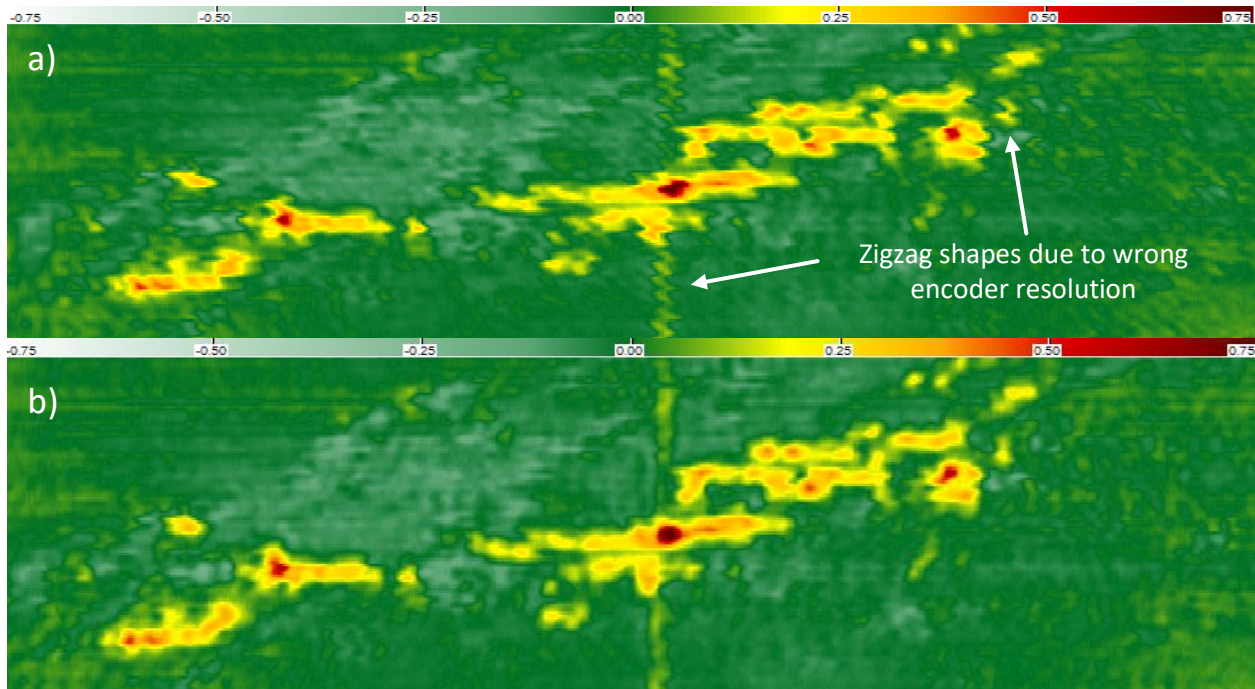

Figure 64. a) Before encoder calibration (small error on the encoder's resolution); b) after