

EDDYFI LYFT

Corrosion Assessment Redefined



© Eddyfi NDT, Inc.

3425 Rue Pierre-Arduin
Québec (QC)
G1P 0B3 CANADA

Eddyfi, Lyft, SmartPULSE, and their associated logos are trademarks or registered trademarks of Eddyfi NDT, Inc. Eddyfi reserves the right to change product offerings and specifications without notice.

2020-08-04

Contents

General Precautions and conventions	xi
General Precautions	xii
Safety Precautions	xii
Conventions	xii
Acronyms	xiv
EMC Directive Compliance	xiv
Calibration and Warranty Seals	xv
Limited Warranty	xvi
Copyrights.....	xvi
Lyft System Overview	1
Introducing the Lyft System	2
Positioning Lyft.....	9
Starting Lyft	11
Shutting Down Lyft	11
Connecting Probes	11
Batteries	12
Software overview.....	15
Introducing the Lyft Software	16
Workflow overview	31
TYPICAL Inspection Workflow	32
Creating / Selecting a Project.....	33
Creating / Opening a Component.....	33
Adding / Editing a Scan Zone	34
Creating a Setup.....	35
Applying SmartPULSE™	38

Acquiring Data	40
Recalibrating the Wall Thickness	42
Adding Indications to a report	43
Generating a Report.....	44
Managing Data.....	45
Disabling and Enabling the Multi-Touch Display	48
Remote Control Reference	48
Lyft PRO software	53
Lyft Pro	54
Preferences	58
Managing Preferences	59
Keypad and Keyboard Functions.....	63
Keyboard Shortcut Keys	64
Maintenance and Troubleshooting	65
Maintaining Lyft	66
Updating and Upgrading Software	70
Troubleshooting	73
Specifications	75
General	76
Environmental	76
Probes.....	77
Performances	77
Connector reference.....	79
PEC Connector	80
I/O Connector.....	80
Ethernet Connector.....	80

HDMI Connector	81
USB Connectors	82
Audio Jack.....	82
Using the Optional Harness	83
Adjusting the Harness	84
Setting Up the Extension Pole.....	93
Setting Up the Extension Pole.....	94
Using the array probe straps	97
Locking and unlocking the prove curvature	98

Figures

Figure 1-1 Front view	2
Figure 1-2 Rear view	4
Figure 1-3 Right side view	4
Figure 1-4 Left side view	5
Figure 1-5 Single element probes	6
Figure 1-6 Single element extension pole	7
Figure 1-7 PECA-6CH-MED probe	7
Figure 1-8 PECA-HR-SM probe	8
Figure 1-9 Lyft in the horizontal position	10
Figure 1-10 Lyft in the tilted position	10
Figure 1-11 Shutting down Lyft	11
Figure 1-12 Optional battery charger	13
Figure 2-1 Backstage view: General	16
Figure 2-2 Backstage view: Scan Area	17
Figure 2-3 Backstage view: Report Summary	18
Figure 2-4 Backstage view: Documentation	19
Figure 2-5 Backstage view: Help	19
Figure 2-6 Support package window	20
Figure 2-7 Front-stage view	20
Figure 2-8 A-scan view	22
Figure 2-9 Tau-scan view	22
Figure 2-10 C-scan view	23
Figure 2-11 Information view	23
Figure 2-12 Home ribbon	25
Figure 2-13 Setup ribbon	27
Figure 2-14 Layout ribbon	27

Figure 2-15 Current A-Scan View Ribbon28

Figure 2-16 Current Tau-scan View Ribbon.....28

Figure 2-17 Current C-Scan View Ribbon29

Figure 2-18 Current Information View Ribbon.....29

Figure 2-19 Analysis Ribbon 30

Figure 2-20 Edge smoothing dialog box..... 30

Figure 3-1 Typical inspection workflow.....32

Figure 3-2 Open dialog box33

Figure 3-3 Create Component dialog box..... 34

Figure 3-4 Open dialog box..... 34

Figure 3-5 Add Scan Zone dialog box.....35

Figure 3-6 Probe selection 36

Figure 3-7 Scan definition 36

Figure 3-8 Encoder configuration.....37

Figure 3-9 Probe positioning image.....37

Figure 3-10 SmartPULSE dialog box..... 38

Figure 3-11 PEC Autoset dialog box 39

Figure 3-12 Wall Thickness Calibration dialog box..... 39

Figure 3-13 Repeatability Optimization dialog box..... 40

Figure 3-14 Wall Thickness Calibration dialog box.....42

Figure 3-15 Placing cursor over target defect..... 43

Figure 3-16 Add indication dialog box..... 43

Figure 3-17 Indication added 44

Figure 3-18 Generate report 44

Figure 3-19 Generate Report dialog box..... 45

Figure 3-20 Component Transfer dialog box 46

Figure 3-21 Project Transfer dialog box.....47

Figure 3-22 Help section	47
Figure 3-23 Setup Tab.....	48
Figure 4-1 External Path Selection dialog box.....	54
Figure 4-2 Scan Area section.....	55
Figure 4-3 Calibration Propagation dialog box.....	55
Figure 4-4 Selecting the C-scan.....	56
Figure 4-5 CWT% C-scan	56
Figure 5-1 System preferences	59
Figure 5-2 Selecting a Logo	59
Figure 5-3 System preferences.....	60
Figure 5-4 Wi-Fi Networks dialog box.....	60
Figure 5-5 Display Preferences.....	61
Figure 6-1 Keyboard Shortcuts dialog box.....	64
Figure 7-1 Encoder and replacement clamp ring.....	67
Figure 7-2 Pliers in expanding configuration	68
Figure 7-3 Clamp ring sitting on plier	69
Figure 7-4 Clamp ring installation.....	69
Figure 7-5 Clip-on encoder protective cap	70
Figure 7-6 Update dialog box.....	71
Figure 7-7 Options menu	71
Figure 7-8 System recovery interface	72
Figure B-1 Slipping the harness on	84
Figure B-2 Adjusting the shoulder straps	85
Figure B-3 Adjusting the belt's height	85
Figure B-4 Securing the chest straps.....	86
Figure B-5 Securing the belt.....	86
Figure B-6 Shoulder anchor straps	87

Figure B-7 Unfastening the straps87

Figure B-8 Sliding strap loop through bumper hook 88

Figure B-9 Securing anchor strap..... 88

Figure B-10 Alternative method of securing anchor strap to bumper..... 89

Figure B-11 Anchor strap on harness belt 89

Figure B-12 Slipping male buckle through bumper 90

Figure B-13 Mating battery compartment side anchor strap 90

Figure B-14 Closing battery compartment door..... 91

Figure B-15 Mating shoulder anchor strap 91

Figure B-16 Tightening shoulder anchor straps92

Figure B-17 Belt-slinging probe cable92

Figure C-1 PEC probe supports and screws..... 94

Figure C-2 Securing supports to PEC probe 94

Figure C-3 Sliding PEC probe on extension pole head 95

Figure C-4 Securing PEC probe to extension pole head 95

Figure C-5 Running PEC probe cable through pole hoops..... 95

Figure C-6 Connecting PEC probe connector to extension pole remote control 96

Figure D-1 Locked latches 98

Figure D-2 Unlocked latches..... 98

Figure D-3 Probe on a pipe with curvature locked 99

Figure D-4 Carriage installed on the straps..... 100

Figure D-5 Strap connected to the probe buckles..... 100

Figure D-6 Handle installed on module 6..... 101

Figure D-7 Installed Erasable marker 101

Figure D-8 Grid-As-U-Go the PECA probe..... 102

Figure D-9 Installed Grid-A-U-Go 102

Tables

Table 1-1 Lyft single-element probe status LEDs	Error! Bookmark not defined.
Table 1-2 Lyft array probe status LEDs	9
Table 2-1 Multi-touch behavior in the C-scan view	25
Table 3-1 Analysis mode remote control reference	Error! Bookmark not defined.
Table 3-2 Grid mapping data acquisition remote control reference	49
Table 3-3 Dynamic mode data acquisition remote control reference	50
Table 3-4 SmartPULSE remote control reference	50
Table 3-5 Survey mode remote control reference	50
Table 3-6 PEC Autoset remote control reference	50
Table 3-7 Wall thickness calibration remote control reference	51
Table 3-8 Repeatability optimization remote control reference	51
Table 6-1 Keyboard shortcut keys	64
Table 8-1 General specifications	76
Table 8-2 Environmental specifications	76
Table 8-3 Single-element probes specifications	77
Table 8-4 Array probes specifications	77
Table 8-5 Performances	77
Table A-1 I/O connector data	80
Table A-2 I/O connector pinout	80
Table A-3 Ethernet connector data	80
Table A-4 Ethernet connector pinout	81
Table A-5 HDMI connector data	81
Table A-6 HDMI connector pinout	81
Table A-7 USB connector data	82
Table A-8 USB connector pinout	82
Table A-9 Audio jack data	82
Table A-10 Audio jack pinout	82

General Precautions and conventions

General Precautions

The following safety precautions are to be observed at all times when using Lyft®. Make sure that you review them **before** turning on the system.

- Keep this document in a safe place for future reference.
- Carefully follow the installation and operation procedures detailed herein.
- Respect the safety warnings on the instrument and in this document.
- Lyft should only be used by qualified personnel.
- When transporting Lyft, it is your responsibility to make sure that you apply the safety precautions dictated by the relevant local governing bodies.
- Always connect the power supply to a properly grounded receptacle, extension cord, or power bar. Grounding a single conductor of a two-conductor outlet is not sufficient protection for Lyft.
- Only connect the system to a power source corresponding to the type indicated on the rating plate.
- If you use the system in a manner that deviates from that specified by Eddyfi, the protection provided on the equipment may be rendered null and void.
- Do not use substitute parts or perform unauthorized modifications to the system.
- Service instructions, when applicable, are intended for trained service personnel only.
- Always make sure that the system is unplugged from any power supply before servicing.
- To avoid dangerous electric shock, do not perform any service on the system unless qualified to do so. If you encounter any problems or have questions regarding this system, contact Eddyfi or an authorized Eddyfi representative.

Safety Precautions

Observe the following safety precautions scrupulously when using Lyft.

Rear Stand

Because Lyft is a portable system, it is designed to be used under tough conditions. It is, however, not indestructible. To avoid damaging Lyft, use its rear stand when operating Lyft in a tilted position. Do not use Lyft in the upright position, as it may topple over or fall off the work surface.

Conventions

Typographical

The following typographical conventions are used throughout this document:

Italic

Used for file names and paths.

Bold

Used to indicate menu items, named user interfaces, and place emphasis on specific words or phrases. Items in bold type are capitalized to reflect the actual interface.

SMALL CAPITALS

Used to indicate instrument interface indications

Marking and Symbols

The following symbols appear on the instrument and pertain to safety regulations that should be carefully observed:



This label is used as a general warning sign. It indicates that you should refer to this user's guide to obtain the necessary information for proper protection of the instrument and its users.



This label is used to indicate high voltage. It draws your attention to the presence of hazardous voltages (within the product enclosure or accessible externally) that may constitute a risk of electric shock to persons. Always refer to the user's guide to ensure proper protection and safety.



The RoHS compliance logo signifies that this product complies with the Restriction of Hazardous Substances directive 2002/95/EC. This directive restricts the use of lead, mercury, cadmium, hexavalent chromium, polybrominated biphenyl, and polybrominated diphenyl ether in certain classes of electrical and electronic units as of July 1, 2006.



This label acts as a reminder that you should dispose of this system in accordance with your local Waste Electrical and Electronic Equipment (WEEE) regulations. This system was manufactured to the high-quality standards of Eddyfi to ensure safe and reliable operation when it is used as stated in this document. Due to its nature, this instrument may contain small quantities of substances known to be hazardous to the environment and to human health if released in the environment. As such, systems falling under WEEE regulations should not be disposed of in the public waste stream.

Safety Indications in This Document

The safety indications in this document are intended to ensure your safety and the integrity of the system.



Warning

The warning indication calls your attention to a procedure or a practice (or the like) that, if performed incorrectly, can result in injury. Do not ignore warning indications — make sure that you understand the condition before proceeding.



Caution

The caution indication calls your attention to a procedure or practice (or the like) that, if performed incorrectly, can result in material damage, loss of data, or both. Do not ignore caution indications — make sure that you understand the condition before proceeding.

Important

Calls attention to information important to completing tasks.

Note

Calls attention to an operating procedure, a practice, or the like that requires special attention. Notes also indicate useful related, but parenthetical information that is unessential.

Acronyms

PEC: Pulsed Eddy Current

PECA: Pulsed Eddy Current Array

CWT: Compensated Wall Thickness

EMC Directive Compliance

FCC Compliance (USA)

This equipment was tested and found to comply with the limits for a Class A digital device, pursuant Part 15 of the FCC Rules. These limits are designed to provide reasonable protection against harmful interference when the equipment is operated in a commercial environment. This equipment generates, uses, and can radiate radio frequency energy and, if not installed and used in accordance with the user's guide, may cause harmful interference to radio communications. Operation of this equipment in a residential area is likely to cause harmful interference in which case you will be required to correct the interference at your own expense.

ICES Compliance (Canada)

This ISM device complies with Canadian ICES-001.

Cet appareil ISM est conforme à la norme NMB-001 du Canada.

AS/NZS Compliance (Australia/New Zealand)

This device complies with Australia and New Zealand AS/NZS 4252.2 (IEC 61000-6-4) and AS/NZS 61000-6-2 (IEC 61000-6-2).

Calibration and Warranty Seals

The calibration seal is at the back of the instrument. Lyft is also equipped with a warranty seal.

Important

Broken seals void the calibration certification and product warranty.

Limited Warranty

Eddyfi NDT, Inc. warrants the hardware to be free of any defects in materials or workmanship for a period of twelve (12) months from the date of delivery, under normal use and service. These warranties are limited to the original purchase of the product and are not transferable.

Eddyfi NDT, Inc. will repair or replace any product component or documentation, at its option and at no additional charge if found defective within the warranty period. The purchaser is responsible for returning the product to Eddyfi NDT, Inc.

Eddyfi NDT, Inc., will not be held responsible in any way whatsoever for damage resulting from improper installation, accident, misuse, or from service or modification of the product by anyone other than Eddyfi NDT, Inc., or an authorized Eddyfi NDT, Inc. service center.

Eddyfi NDT, Inc. will not be held responsible in any way whatsoever for direct, indirect, special, incidental, or consequential damages resulting from possession, use, improper installation, accident, service, modification, or malfunction of the product (including, without limitation, damages for loss of business profits, business interruption, loss of business information, or other pecuniary loss). Eddyfi's total shall in no event exceed the purchase price of the applicable item(s).

This warranty is in lieu of all other warranties, whether oral, written, expressed, or implied, including any warranty of merchantability or fitness for a particular purpose, and no other representation or claims of any nature shall be binding on or obligate Eddyfi NDT, Inc.

This agreement is governed by the laws of the province of Québec, Canada. Each of the parties hereto irrevocably attorns to the jurisdiction of the courts of the province of Québec and further agrees to commence any litigation which may arise hereunder in the courts located in the judicial district of Québec.

Copyrights

This document and the product and programs it describes are protected by the Copyright Act of Canada, by laws of other countries, and by international treaties, therefore may not be reproduced, in whole or in part, whether for sale or not, without prior written consent from Eddyfi NDT, Inc. Under copyright law, copying includes translation in other languages and formats.

© Eddyfi NDT, Inc., 2020

This document was prepared with particular attention to usage to ensure the accuracy of the information it contains. It corresponds to the version of the product manufactured prior to the date appearing on the back cover. There may, however, be some differences between this document and the product if the product was modified after publication.

The information contained in this document is subject to change without notice.

Chapter 1

Lyft System Overview

Introducing the Lyft System

Thank you for purchasing Eddyfi's Lyft®. This chapter is intended to give you an overview of the system and its components before operation.

What's in the Box

Lyft comes with the following standard accessories:

- Two, high-capacity batteries
- One power adapter (100-240 V)
- Power cords (one for North America, one for Europe)
- User documentation
- Stylus
- Transport case

Instrument Overview

Front

Figure 1-1 Front view

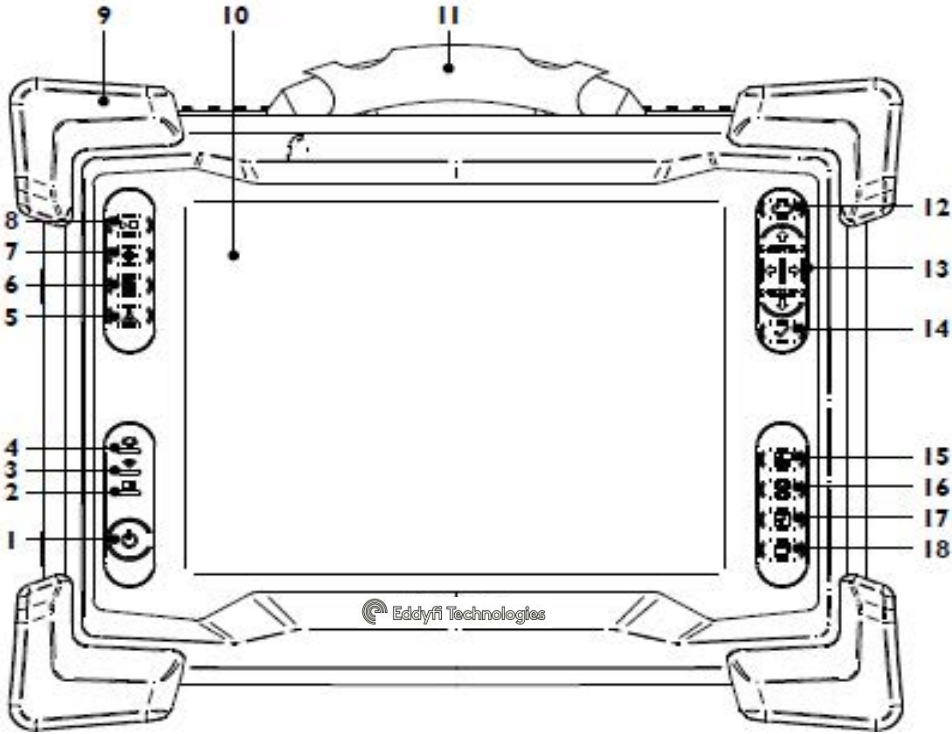

1. Power button

Short press (approximately 0.5 to 4 seconds):
Use to turn the instrument on and off. The power indicator at the center of the button behaves as follows:

- Green: Lyft is on
- Blinking yellow/orange: Lyft is on standby
- Unlit: Lyft is off

Long press (approximately greater than 4 seconds):

If the instrument is on, a long press will initiate a forced shutdown.

If the instrument is off, a long press will activate RDAU mode, which allows the user to operate the instrument remotely from a laptop. Press and hold the power button until the alarm indicator light flashes, then release the power button. The power button light will continue to flash while in RDAU mode.

2. Battery indicator

Displays the state of Lyft's batteries when the instrument is on. Depending on the power mode (DC or battery), the indicator behaves differently:

DC power

- Green: batteries fully charged
- Blinking green: batteries charging
- Red: battery or charger error
- Unlit: no batteries in Lyft

Battery power

- Unlit: remaining charge over 40 %
- Orange: remaining charge 20-40 %
- Blink yellow: remain. charge less than 20 %
- Red: battery error

3. Wi-Fi indicator

Displays the Wi-Fi status. When the indicator is lit, the Wi-Fi is enabled. When it is off, the Wi-Fi is disabled.

4. Alarm indicator

Used to display user- programmed errors. The indicator remains unlit until it detects a predefined error condition, at which time it lights red.

5. Wall thickness calibration button

Use to perform a wall thickness calibration at the nominal thickness. A short press calibrates on a new point, while a long press calibrates on the data at the cursor's location.

6. Index button

Use to increment the index line during data acquisition.

7. Get point button

Only use during data acquisition in grid-mapping mode. It allows performing a measurement at the cursor coordinates.

8. Start / Stop acquisition button

Use to start or stop data acquisition.

9. Heavy-duty bumpers

The four corner bumpers provide shock absorption and support Lyft at an angle when it is set on a flat surface. The bumpers are also hooked for harnessing. For details about harnessing, see page 84.

10. Multi-touch display

10.4 ", non-reflective, high-resolution display.

11. Handle

Use this handle when carrying Lyft.

12. Keypad arrow mode selection/ Disable touchscreen button

Press to select the operation mode of the keypad arrows (see 13). Long press this button to disable or enable the touchscreen (depending on its state). Follow the instructions on the screen to complete the operation.

13. Keypad arrows

Use these arrows to navigate the Lyft software interface according to the selected mode.

14. Enter button

Enter key. Closes text boxes.

15. Change active view button

Press to activate a different view than the one currently active.

16. Data display button

When PEC array probes are connected to the instrument: used to activate the Probe Guides in the C-Scan. Unused with single-element probes.

17. Maximize/Minimize view button

Use this button to maximize or minimize the active view.

18. Change layout button

Use this button to change the Lyft software layout to another predefined one.

Rear

Figure 1-2 Rear view

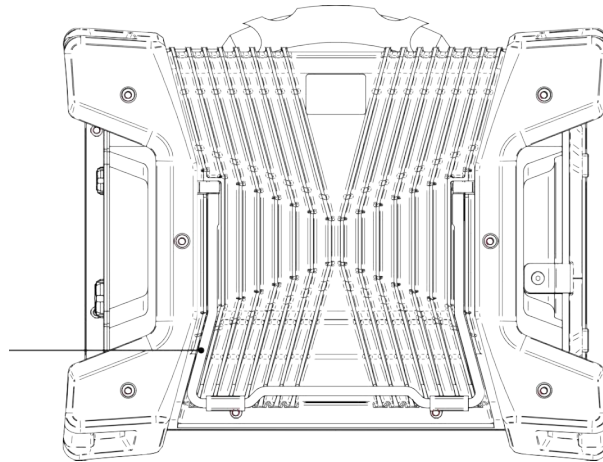

1

1. Instrument stand

This stand retracts outward to hold Lyft at an angle, preventing the instrument from falling over horizontally.

Right

Figure 1-3 Right side view

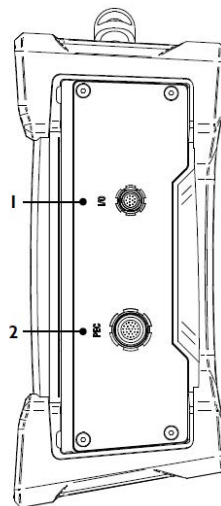

1. I/O connector

Used to communicate with the probe's encoder, for example

2. PEC connector

Connect your PEC probes to this connector.

Left

Figure 1-4 Left side view

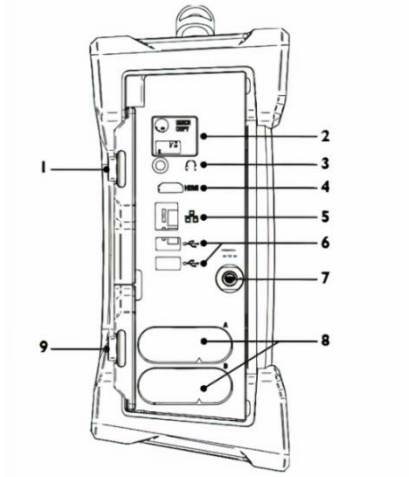
**1. Protective connector door**

Protects the Lyft's connectors from the elements when they are not in use.

2. Quick copy

Use the Quick copy button to transfer all your inspection data to a USB mass storage device.

3. Audio connector

Use this connector to hook up a headset to Lyft.

4. HDMI® connector

Use this connector to hook up an external monitor to Lyft.

5. Network connector

Use to connect Lyft a local area network (LAN). This connector is equipped with two indicators with the following behavior:

Connection indicator (upper)

- Green: communication established between Lyft and the network
- Blinking green: activity between Lyft and the network
- Unlit: no link to network

Connection speed indicator (lower)

- Amber: operating as a gigabit connection (1 Gbps)
- Green: operating as a 100 Mbps connection
- Off: operating as a 10 Mbps connection

6. USB 2.0 connectors

Use these connectors to hook up USB devices to Lyft such as a mouse or external disk drive.

7. Power connector

Use the supplied power cord to operate Lyft and recharge the batteries.

8. Battery compartments

Insert the supplied batteries into the appropriate battery compartment. For details about batteries, see page 12.

9. Protective battery compartment door

Protects the battery compartments from the elements.

Single-element Probe Overview

Lyft single-element probes come in three sizes, small, medium, and large. They feature the same components.

Figure 1-5 Single element probes

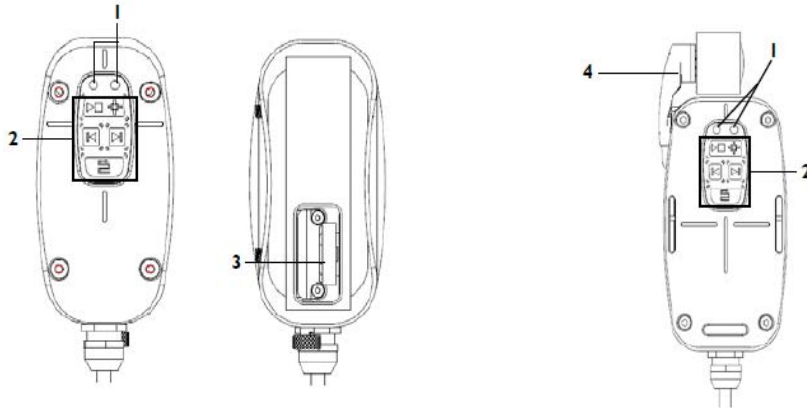

First-generation probes

1. Status LEDs

The green LED on the left and the red LED on the right convey information to users, as outlined below

2. Remote controls

Used to perform a variety of operations without handling the instrument. See page 48.

Second-generation probes

3. Built-in encoder

First-generation probes are equipped with a high-precision, 20.53 counts/mm encoder.

4. Clip-on encoder

Second generation probes are equipped with high-precision, 16.04 counts/mm encoder

Table 1-1 Lyft single-element probe status LEDs

Green	Red	Status
Off	Off	Probe unconnected or unable to receive data.
1 Hz blinking (slow)	Off	Analysis mode: Probe detected and waiting for action.
10 Hz blinking (normal)	Off	Acquisition mode: Data is being acquired. PEC Autoset: Routine is running. Wall thickness calibration: Routine is running. Repeatability optimization: Routine is running.
20 Hz blinking (fast)	Off	Dynamic acquisition mode: The probe's position is outside the scan zone.
20 Hz blinking (fast)	20 Hz blinking (fast)	PEC Autoset: Routine failed or was canceled. Wall thickness calibration: Routine failed or was canceled. Repeatability optimization: Routine failed or was canceled.
On	Off	Grid mapping acquisition mode: Probe ready to perform acquisition. PEC Autoset: Probe ready to perform routine. Wall thickness calibration: Probe ready to perform routine. Repeatability optimization: Probe ready to perform routine.
Off	On	Dynamic acquisition mode: Probe moving too quickly on sample. Other circumstances: Error occurred during requested operation.

Single-Element Probes Accessories

For details about these accessories, refer to the PEC probe catalog.

Single-Element Extension Pole Overview

For details about how to install a single-element or splash zone probe on the extension pole, see [Setting Up the Extension Pole](#) page 94.

Figure 1-6 Single element extension pole

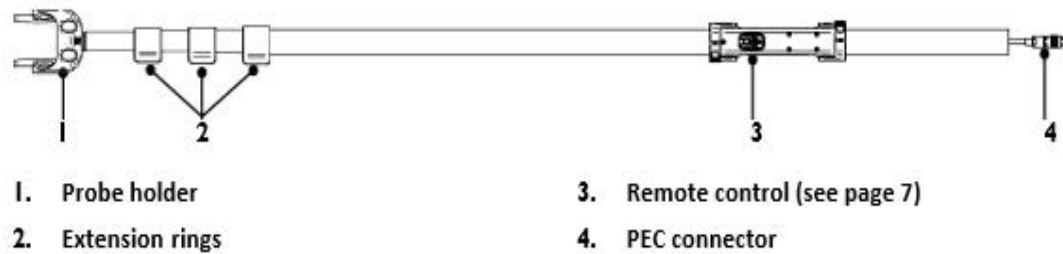

PECA Probes Overview

The PECA-6CH-MED-XXX-GA and PECA-6CH-MED-XXX-GDA 6-element PECA probes are capable of a single-pass coverage of 457 mm (18 in) in grid or high-resolution, dynamic mode.

Figure 1-7 PECA-6CH-MED probe

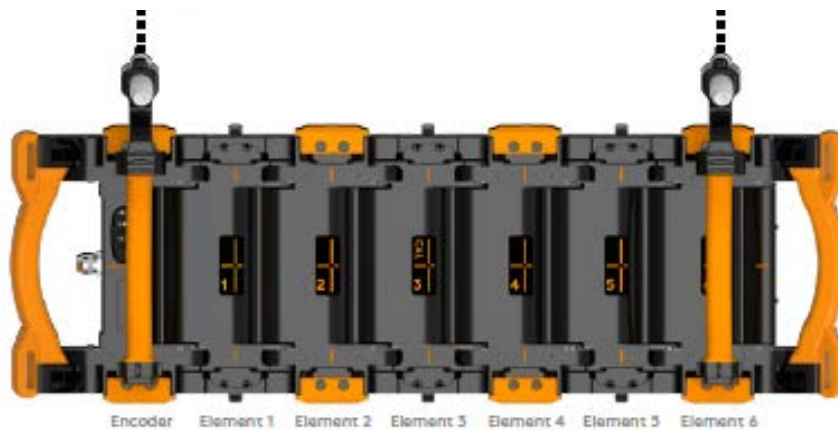

PECA-6CH-MED probes roll on wheels that lift them off 12.7 mm (0.5 in) to ease inspection on insulated pipes with straps and buckles securing the insulation. Do not add this additional liftoff to the insulation thickness when calculating your probe's footprint or smallest detectable defect. You can remove the wheels to use the probe in restricted-access situations.

PECA-6CH-MED probes are also designed to wrap around curved surfaces like pipes. Once curved, lock the shape by pressing the locking handles toward the probe's body. You will get the best sizing results when all the probe elements are curved by the same amount, forming a circular arc. Positioning marks are visible on the probe to validate the relative curvature of all array elements. To see how to lock and unlock the probe body, see [Appendix D](#), page 97.

The probes are equipped with the same buttons as single-element probes. The red, green, and blue LEDs indicate the operational status of the probes.

Figure 1-8 PECA-HR-SM probe



The encoder on the PECA-HR-SM is the same clip-on encoder as the single-element probes. The PECA-6CH-MED probe has a longer travel.

The probes are equipped with the same buttons as single-element probes. The red and green LEDs indicate the operational status of the probes. The blue LED is only on the PECA-6CH-MED probe.

Table 1-2 Lyft array probe status LEDs

Green	Red	Blue	Status
Off	Off	-	Probe unconnected or unable to receive data.
1 Hz blinking (slow)	Off	-	Analysis mode: Probe detected and waiting for action.
10 Hz blinking (normal)	Off	-	Acquisition mode: Data is being acquired. PEC Autotest: Routine is running. Wall thickness calibration: Routine is running. Repeatability optimization: Routine is running.
20 Hz blinking (fast)	Off	-	Dynamic acquisition mode: The probe's position is outside the scan zone.
20 Hz blinking (fast)	20 Hz blinking (fast)	-	PEC Autotest: Routine failed or was canceled. Wall thickness calibration: Routine failed or was canceled. Repeatability optimization: Routine failed or was canceled.
On	Off	-	Grid mapping acquisition mode: Probe ready to perform acquisition. PEC Autotest: Probe ready to perform routine. Wall thickness calibration: Probe ready to perform routine. Repeatability optimization: Probe ready to perform routine.
Off	On	-	Dynamic acquisition mode: Probe moving too quickly on sample. Other circumstances: Error occurred during requested operation.
-	-	On	Dynamic acquisition mode: Encoder is moving. The blue LED is switched off if the Red LED is active. Other circumstances: Unused.
-	-	Off	Dynamic acquisition mode: Encoder is stopped. Other circumstances: Unused.

PECA Probes Accessories

For details about PECA probes accessories, refer to the [PEC probe catalog](#). To learn how to install the probe on a pipe using accessory straps and carriages, see appendix D on page 97

Application-Specific Probes and Accessories

For details about the splash zone, underwater, galvanized-steel and tank floor probes, as well as cables and other PEC accessories, refer to the [PEC probe catalog](#).

Positioning Lyft

Lyft must be properly positioned prior to use so that you do not run the risk of dropping the instrument or the instrument falling over. Lyft has two safe operating positions: horizontal and tilted. To use Lyft in a tilted position, simply pull out the stand located at the rear of the instrument until Lyft is at the desired angle. If you are using Lyft with the optional harness, see Adjusting the Harness on page 84 for details.

Figure 1-9 Lyft in the horizontal position

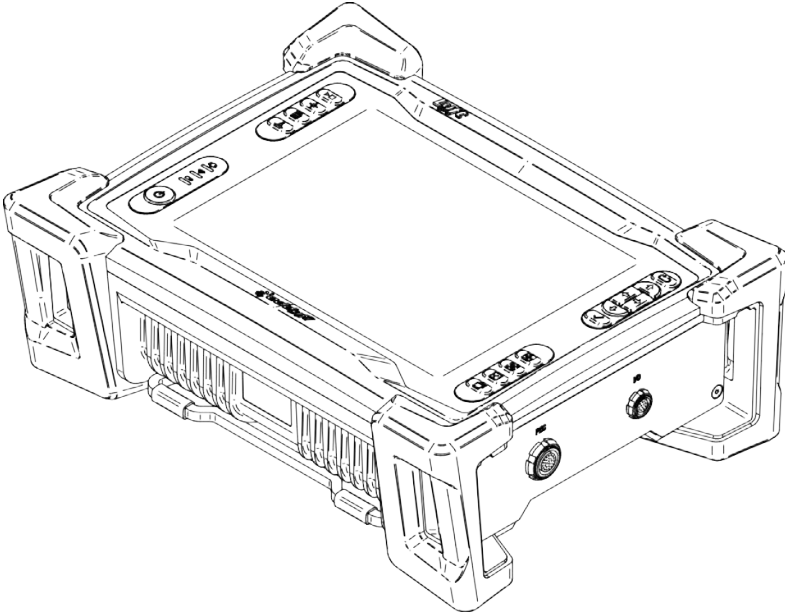
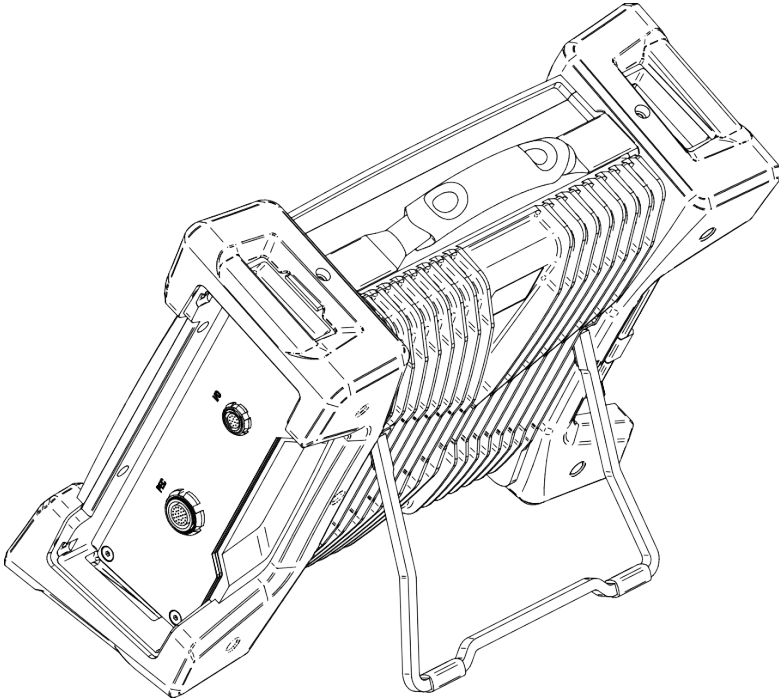

Figure 1-10 Lyft in the tilted position





Caution

It is possible to use Lyft while it rests on its lower bumpers, but this is **not a safe operational position** as the instrument may fall over. If you want to use Lyft at an angle, use the stand located at the rear of the instrument.

Important

Regardless of how you position the instrument, you must always have a minimum clearance of 10 cm (4 in) on all sides of the instrument. Always position the instrument away from heat sources. This ensures proper heat dissipation while the instrument is in use.

Starting Lyft

Proceed as follows to turn on your instrument or exit the standby mode:

1. Make sure that at least one of the two batteries is inserted into the battery compartment A of the instrument or that the instrument is plugged to an external power source using the supplied power cord.
2. Press the power button.
The power indicator at the center of the power button lights green.

Shutting Down Lyft

Proceed as follows to shut down your instrument:

1. Save all your data.
2. Press the power button.
Four option buttons appear on the display.

Figure 1-11 Shutting down Lyft

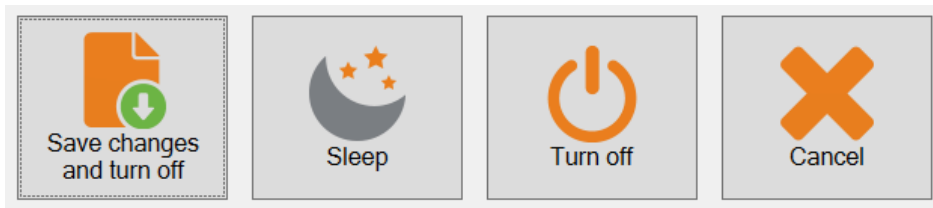

3. Tap the button of your choice.
The instrument shuts down.

Connecting Probes

Connecting a PEC Probe

Eddyfi PEC probes come in three models: small, medium, and large. These probes hook up to Lyft's PEC connector. Proceed as follows to do so:

1. If you have not already done so, remove Lyft from its carrying case and place it on your work surface as outlined in Table 2 on page 9
2. If you have not already done so, remove the protective caps from the PEC and I/O connectors.
3. Align the probe's 27-pin male connector with the PEC connector on the instrument.

Hint

The alignment mark on the connector should be facing you when you face the instrument.

4. Push the connector until you hear it click.

5. Align the probe's 12-pin male encoder connector with the I/O connector on the instrument.
Hint
The alignment mark on the connector should be facing you when you face the instrument.
6. Push the connector until you hear it click.

Batteries

Lyft can be used under battery power. The instrument is designed with two battery cradles under the protective battery compartment door but Scan be powered by a single battery. Lyft uses Li204SX-7800 lithium-ion rechargeable batteries from Emerging Power, which do not suffer from the memory effect affecting previous generations of batteries.

Warning

Whenever carrying Lyft in its transport case, remove the batteries from the instrument and make sure that they cannot come in contact during transport, as this poses a significant fire and explosion hazard.

When carrying Lyft, it is the user's responsibility to make sure that the safety precautions used are in accordance with the local department of transportation (or equivalent governing body) rules and regulations.

Lyft's transport case comes with two slots, fitted to receive the batteries when removed from the instrument.

Note

Make sure that you do not replace the batteries by batteries other than Li204X-7800 lithium-ion rechargeable batteries from Emerging Power. Contact your Eddyfi representative for more information



Inserting/Removing Batteries

Inserting Batteries

1. On Lyft's left side, unlatch the battery compartment's door, and then open it.
2. Align your battery with one of the battery cradles.

Note

Battery cradles are marked A and B. If you are inserting only one battery, it does not matter which of the two cradles you use.

3. Make sure that the battery contacts are facing inward and upward.
4. Slide the battery into the battery cradle until it is fully inserted. You should feel the battery contacts snap into place.

Removing Batteries

1. On Lyft's left side, unlatch the battery compartment's door, and then open it.
2. Grab the battery tab between thumb and forefinger.
3. Pull on the tab.
You will feel the battery contacts being released.
4. Slide the battery out of its cradle.

Hot Swapping Batteries

You can remove one of Lyft's batteries when the instrument is turned on as Lyft can operate with a single battery. Should the power in the remaining battery be insufficient to keep Lyft operating, the instrument shuts down without damaging electronic components, but all your work in progress in the Lyft software (acquisition, etc.) is lost.

Charging Batteries

Note

Batteries do not recharge when their internal temperature exceeds 45 °C (113 °F). Batteries also do not power Lyft when the instrument's internal temperature exceeds 55 °C (131 °F).

Using the Optional Battery Charger

An optional battery charger is available from Eddyfi. Contact your Eddyfi representative for more information about pricing and availability. This charger conditions and calibrates the instrument's batteries, which is important to maximize their lives. We recommend calibrating the batteries every six months.

Figure 1-12 Optional battery charger

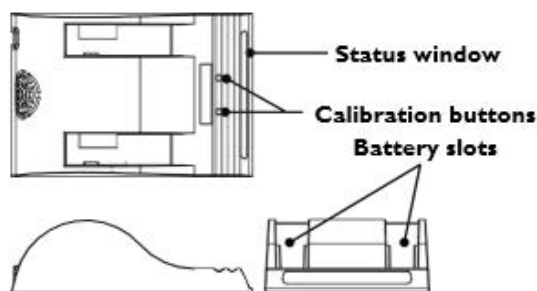

To charge the batteries with the optional charger:

1. Place the charger on a flat and level surface, away from heat and moisture sources.
2. Insert the power supply's DC connector into the back of the external charger.
3. Connect the power supply to an AC supply using the supplied cable. All the LEDs flash momentarily to let you know that power is present.
4. Insert the batteries into the battery slots while making sure that the contacts are fully seated. The charger automatically begins charging the batteries and the LEDs in the status window display the following information:
 - Blinking green: battery charging
 - Green: battery fully charged
 - Blinking blue: battery calibrating
 - Blue: battery charge gauge calibrated
 - Blinking red: battery charge gauge in need of calibration
 - Red: error

Calibrating Batteries

To ensure that your batteries perform at their full capacity for the longest possible time, it is important to calibrate them on a regular basis. Calibration involves a standard battery charge followed by a deep discharge, and then a complete charge. This procedure usually takes 10 to 13 hours, whereas a standard charge only takes approximately 3.5 hours.

Calibrate batteries by placing them in the optional charger and then pressing the calibration button. We recommend calibrating your batteries at least every six months.

Storing Batteries

Whenever transporting Lyft in its case, **remove the batteries** from the instrument, place them in plastic bags, and then make sure that they **cannot come in contact** during transport, as this is a significant fire and explosion hazard. Lyft's transport case is outfitted with two slots intended for the batteries. We recommend that you take advantage of them.

Chapter 2

Software overview

Introducing the Lyft Software

The software running on Lyft® is a powerful and easy-to-use acquisition and analysis software. It is specifically designed for pulsed eddy current inspections and relies on intuitive wizards to configure setups.

The software benefits from a graphical user interface (GUI) designed to simplify the inspection process and enhance your experience. The multi-touch display is the best way of interacting with Lyft, but you can also use a USB mouse and keyboard, if necessary.

Through the GUI, all the functions associated to inspection project management, the global settings, and the preferences are in what is referred to as the backstage view. All inspection work, calibration, acquisition, and analysis are in what is referred to as the front-stage view. This is how the software offers a streamlined and coherent interface that makes the learning process easy.

Backstage Overview

The backstage view is composed of five sections.

General Section

The default section and the first section of the backstage view are the **General** section, which contains information about:

- Probe currently connected to Lyft
- Component description (pipe, insulation, jacket)
- Current scan zone

This is where you:

- Select project folders
- Create, open, edit, or duplicate components
- Transfer components and projects
- Generate reports

Figure 2-1 Backstage view: General

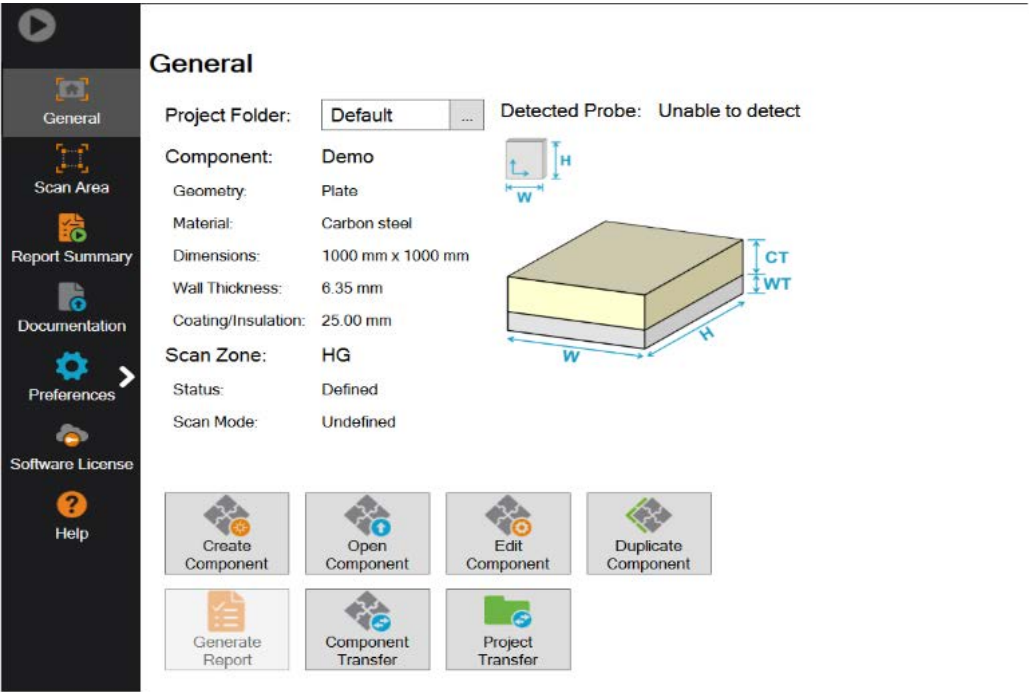

Scan Area Section

This section of the backstage contains information about the loaded scan zone and all the scan zones of the component. This is where you (upper portion of the view):

- Create setups
- Start inspections
- Duplicate the loaded scan zone
- Close scan zones for modification
- Also (bottom portion of the view):
- Add new scan zones
- Delete scan zones
- Edit scan zones
- Load scan zones

Figure 2-2 Backstage view: Scan Area

Scan Area

Loaded Scan Zone:

Name: Zone A
 Status: Ready
 Scan mode: Dynamic

Take screen capture with defect report entry

Create Setup Start Working
 Duplicate Scan Zone Close Scan Zone

Scan Zones:

Name	Mode	Status	Offset (mm)	Width (mm)	Height (mm)
HG	Undefined	Defined	0, 0	1000	1000
Zone A	Dynamic	Ready	0, 0	1000	1000

Delete Add Zone Edit Zone Load Zone

Report Summary Section

This section of the backstage serves to configure the summary included with your reports. This is where you can:

- Add information about the component type, serial number, operator, service company, etc.
- Create new information fields to be included in reports
- Add comments about the component inspection

Figure 2-3 Backstage view: Report Summary

The screenshot shows the 'Report Summary' configuration window. On the left is a dark sidebar with navigation icons for General, Scan Area, Report Summary (selected), Documentation, Preferences, Software License, and Help. The main area is titled 'Report Summary' and contains a table of fields with dropdown menus and orange 'X' delete icons. Below the table is a text area for a comment and three buttons: 'Add', 'Clear', and 'Reset to Default'.

Field	Value	Action
Client	Customer 1	✗
Component Type	Pipe	✗
Component S/N	P12FG567	✗
Site	Refinery XYZ	✗
Service Provider	Eddyfi	✗
Work Order	PO2547	✗
Procedure	ISO-????	✗
Calibration Standard	<enter value>	✗
Inspector	Name ABC	✗
Analyst	NAME DEF	✗

Comment
Comment about the component inspection. Will be exported with the report.

Add Clear Reset to Default

Documentation Section

This section of the backstage allows you to open PDFs located in the **UserData** folder of the instrument. Opening a PDF here can display the document full page for easier reading.

Figure 2-4 Backstage view: Documentation

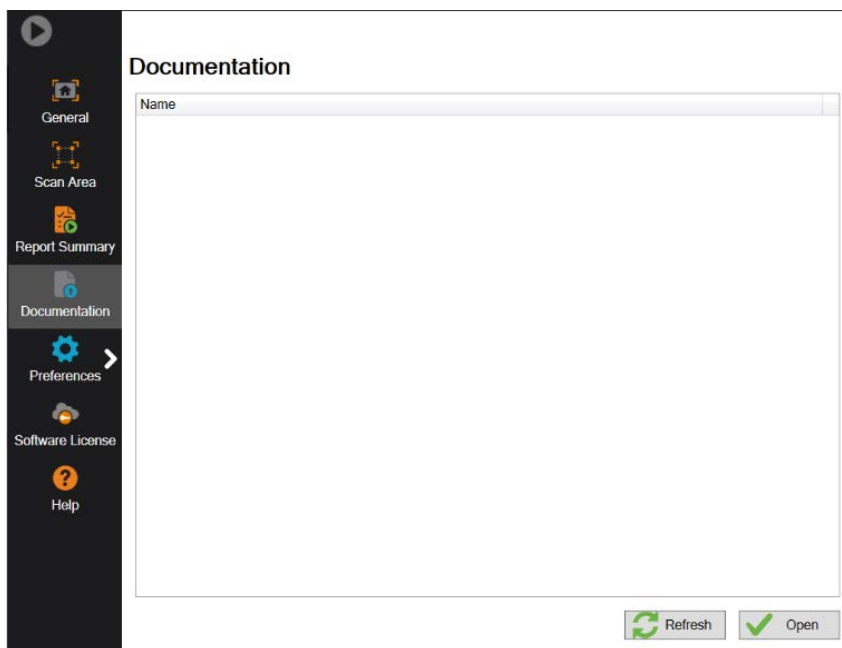

Help Section

This section of the backstage contains information about your instrument/software version and license details. You can also use this section to copy a log file to a USB mass storage device in case you need support for a specific problem you have with the system.

Figure 2-5 Backstage view: Help

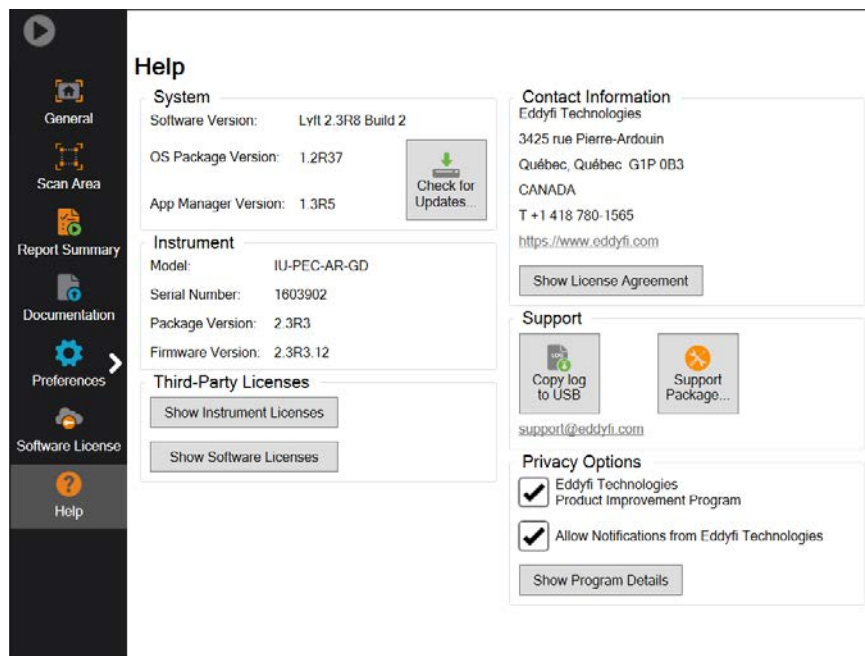

To send Lyft data for support from Eddyfi team, you can use the “support package button”. This allows you to send us data via Wi-Fi without external operation.

Figure 2-6 Support package window

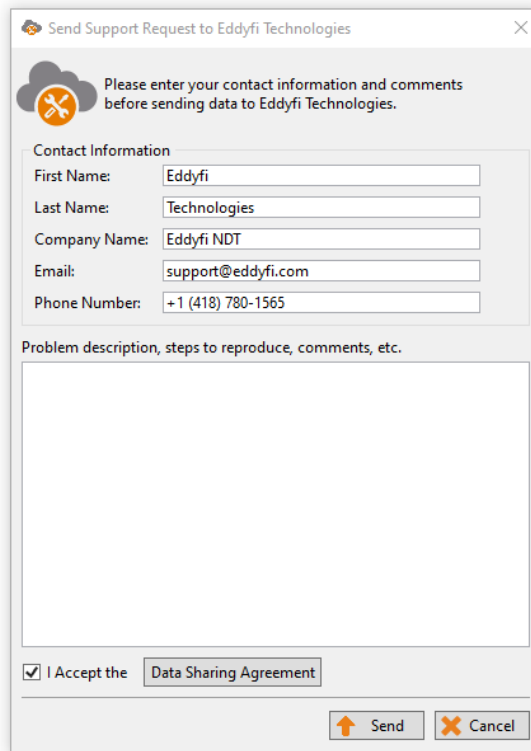

Send Support Request to Eddyfi Technologies

Please enter your contact information and comments before sending data to Eddyfi Technologies.

Contact Information

First Name: Eddyfi

Last Name: Technologies

Company Name: Eddyfi NDT

Email: support@eddyfi.com

Phone Number: +1 (418) 780-1565

Problem description, steps to reproduce, comments, etc.

I Accept the Data Sharing Agreement

Send Cancel

Front Stage Overview

The front stage displays all the information about your current inspection. This is where you will find all the tools to acquire, save, and analyze inspection data.

Figure 2-7 Front-stage view

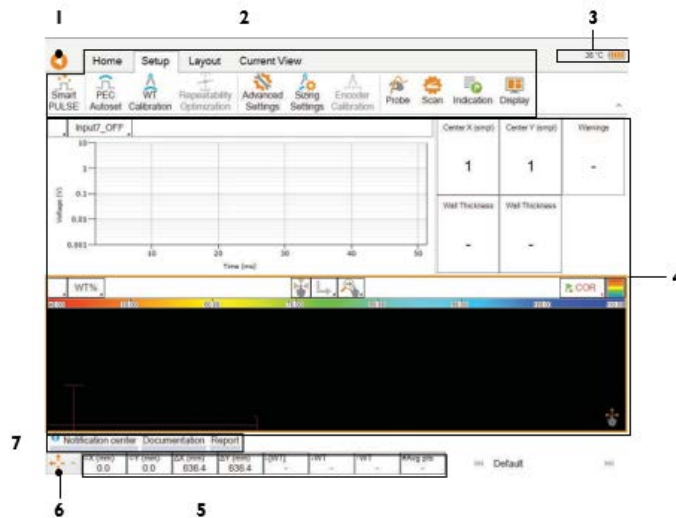

1. Backstage icon

Tap to access the backstage view.

2. Ribbon-style menus

These five menus allow you to perform several inspection operations. Read on for details.

3. Status icons

These icons convey unit status information graphically. Keep reading for details.

4. Data display

This area is where you see the inspection data.

5. Information

This area displays information about the cursor position, thickness measurements, and acquisition parameters.

6. Keypad arrow mode selector

Tap to change the operational mode of the keypad arrows. See chapter 1 for details.

7. Information tabs

Tap the tabs to display notifications, documentation, or report content. Continue reading for details.

Views

Views vary according to the type of probe you are using. You can select layouts or set one up yourself. This section introduces the various elements of available views.

A-Scan view

Figure 2-8 A-scan view

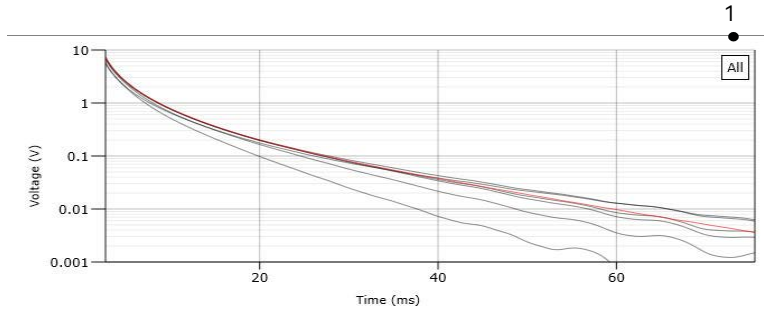

1. Channel displayed in the A-scan

Tau-scan view

The Tau-scan view displays a mathematical transformation of the A-scan to reveal unclear information from this A-scan. Specifically, it is inversely proportional to the first-time derivative of the Log-Lin representation of the A-scan.

Figure 2-9 Tau-scan view

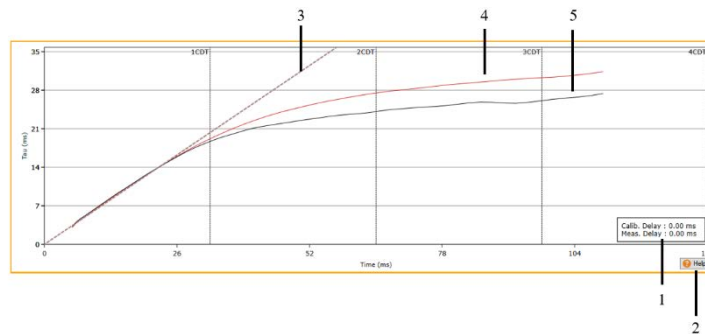

1. The delays are linked with the dot line and indicate the delay in signal due to weather jacket. A difference between both numbers can indicate a wrong setup or a possible jacket overlap.
2. The help button, only in Lyft Pro, is a link to the Help page explaining the τ -scan on the Eddyfi Website.
3. The dot line is the representation of the delay presented in 1.
4. The red line is the calibration line.
5. The black line is the measured point.

C-Scan view

Figure 2-10 C-scan view

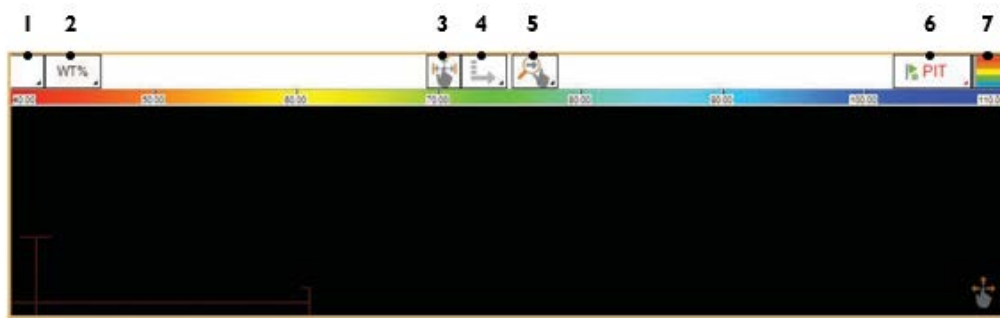

1. Wall thickness C-scan selector

Options are:

- WT%: remaining wall thickness in % according to the nominal wall thickness
- WT: absolute remaining wall thickness
- WL%: wall loss in % according to the nominal wall thickness
- CWT% (only available in Lyft Pro):
Compensated remaining wall thickness in % according to the nominal wall thickness

2. Resize cursor button (toggle behavior)

3. Cursor axis selection for Resize action

4. Zoom orientation selection for the pinch action

5. Report code button used to select/add indications to the report table

6. Show/Hide color palette in the vi

Information View

Figure 2-11 Information view

1	2	3
Next Point X (smp)	Next Point Y (smp)	Warnings
4	12	-
Ch 1	Ch 1	▲
Wall Thickness (mm)	Wall Thickness (%)	
4.2	66.6	
Ch 6	Ch 6	
4	5	

When using an array probe:

- 1.** During acquisition: next position to be acquired on channel 1's X axis.
During analysis: cursor position of selected point on the X axis, regardless of the channel used to capture the point.
- 2.** During acquisition: next position to be acquired on channel 1's Y axis.
During analysis: cursor position of selected point on the Y axis, regardless of the channel used to capture the point.
- 3.** Saturation, over speed, and bad data fitting warnings. Clicking **Warnings** opens the **Warnings Information** dialog box.
- 4.** During acquisition: minimum wall thickness (in percentage) on all array channels. The channel where the minimum is measured is indicated at the bottom.
During analysis: wall thickness (in percentage) at the cursor position, regardless of the channel used to capture the point.
- 5.** During acquisition: minimum wall thickness (in measurement units) on all array channels.
The channel where the minimum is measured is indicated at the bottom.
During analysis: wall thickness (in measurement units) at the cursor position, regardless of the channel used to capture the point.

When using a single-element probe:





- 1.** During acquisition next position to be acquired on the X axis. During analysis: cursor position on the X axis
- 2.** During acquisition: next position to be acquired on the Y axis. During analysis: cursor position on the Y axis
- 3.** Saturation overspeed, bad data fitting warnings. Clicking **Warnings** opens the **Warnings Information** dialog box.
- 4.** Wall thickness (in measurement unit) at the cursor position
- 5.** Wall thickness (in percentage) at the cursor position

Multi-Touch Interface

The Lyft multi-touch interface is designed for ease-of-use. According to your location in the software, the multi-touch behavior changes.

The backstage view uses, dialog boxes, and setup wizards, the multi-touch behavior is standard: a short tap on an element of the GUI enables the associated function, exactly as it would at the click of a mouse. The table below summarizes the various behavior according to the view you are using.

Table 2-1 Multi-touch behavior in the C-scan view

Location	Touch	Behavior	Condition
View toolbars	Tap	PList buttons: Selects the next option in list	
	Touch and hold	Toggles: Enables/disables option List buttons: Displays entire options list	
Data area	Tap	Move cursor to tapped position	
	Touch and move	Move cursor in C-scan Resize the main cursor or miniature cursor along selected axis	 or 
	Pinch-zoom in or out	Zoom in/out based according to mode	

Front Stage Details

Home Ribbon

Figure 2-12 Home ribbon

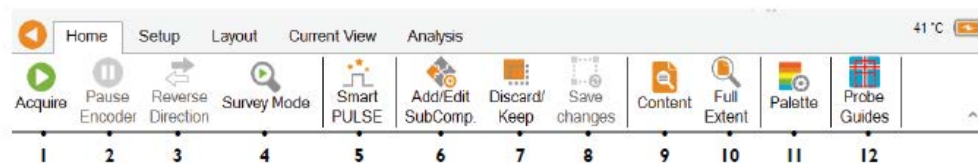

- 1. Acquire**
Tap this button to start and stop your data acquisition.
- 2. Get Point (Grid mode)**
Tap this button to make one-point measurements. This button is only available in grid mode.
Pause Encoder (dynamic mode)
Tap this button to pause the encoder before indexing or repositioning the probe. This button is only available in dynamic mode.
- 3. Reverse Direction**
During grid acquisition, tap this button to change the direction of the automatic increment.
- 4. Survey Mode**
Tap this button to enable the survey mode and acquire data without consigning it to the C-scan. The data remains in memory and allows you to look at different locations before recording. With array probes, the acquired data comes from element 3.
- 5. SmartPULSE**
Tap this button to perform a complete system calibration including PEC AutoSet, WT Calibration, and Repeatability Optimization.
- 6. Add / Edit Sub-Comp.**
Tap this button to add a new or edit an existing subcomponent region when you must calibrate for different wall thicknesses.
- 7. Discard/Keep**
Tap this button to discard invalid data points. Tap it again when the cursor is over a discarded point to reactivate it.
- 8. Update Scan Zone**
Tap this button to save your scan zone to reflect your latest modifications.
- 9. Zoom to Content**
Tap this button to zoom in on to the acquired data content in the C-scan.
- 10. Full Extent**
Tap this button to see the C-scan of the entire defined scan zone.
- 11. Color Palette**
Tap this button to open the Palette Selector enabling you to modify the C-scan color palette in use.
- 12. Probe Guides**
Tap this button to activate the Probe Guides in the C-scan. The Probe Guides show the extension of the array probe on the C-scan in dynamic mode. Unused with single-element probes

Setup Ribbon

Figure 2-13 Setup ribbon

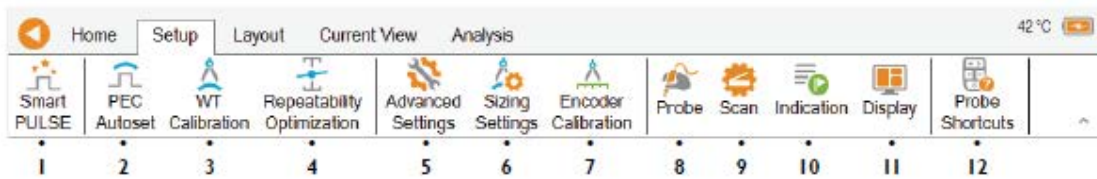

1. **SmartPULSE**
Tap this button to perform a complete system calibration including PEC Autotest, WT Calibration, and Repeatability Optimization.
2. **PEC Autotest**
Tap this button to automatically configure Lyft for an optimum PEC signal.
3. **WT Calibration**
Tap this button to calibrate Lyft on a nominal wall or other known thickness.
3. **Repeatability Optimization**
Tap this button to perform a repeatability optimization, ensuring reliable measurements from Lyft.
4. **Advanced Settings**
Tap this button to modify your setup manually.
5. **Encoder Calibration**
Tap this button to calibrate the encoder resolution.
6. **Sizing Settings**
Tap this button to change the sizing algorithm used in calculating wall thicknesses.
8. **Probe**
Tap this button to select a probe and line filter frequency.
9. **Scan**
Tap this button to select a scanning pattern and select a grid resolution.
10. **Indication**
Tap this button to select and configure the indication codes used in reporting.
11. **Display**
Tap this button to configure the layout of the Lyft display front stage.
12. **Probe Shortcuts**
Tap this button to show a window describing all the functions that can be activated with combinations of buttons on the probe.

Layout Ribbon

Figure 2-14 Layout ribbon

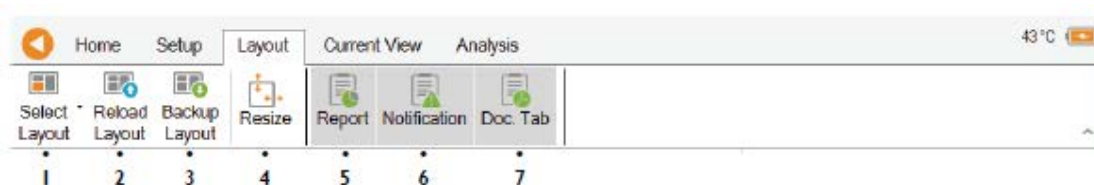

1. **Select Layout**
Tap this button to select a front stage display layout.
2. **Reload Layout**
Tap this button to load a saved display layout.
3. **Backup Layout**
Tap this button to save your current display layout configuration.
4. **Locked**
Tap this button to unlock the layout and enable easier view resizing.
5. **Report Tab**
Tap this button to display or hide the Report tab at the bottom of the front stage.
6. **Notification Tab**

Tap this button to display or hide the Notification center tab at the bottom of the front stage.

7. Doc. Tab

Tap to display or hide the Documentation tab at the bottom of the front stage.

Current A-Scan View Ribbon

Figure 2-15 Current A-Scan View Ribbon

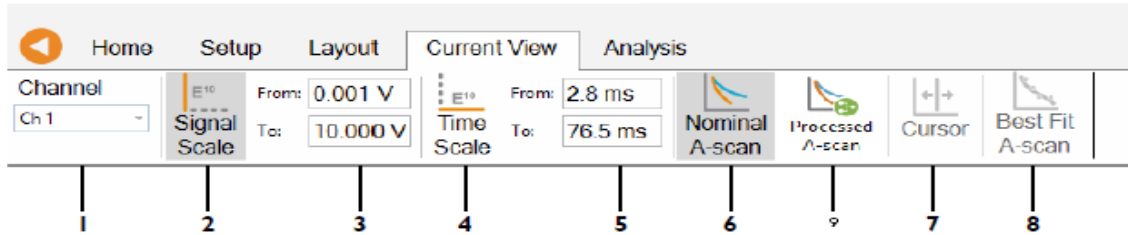

1. Channel selection

Allows to select the channel displayed in the A-scan view. (Not available for array probes)

2. Signal Scale

Tap to switch the vertical axis scale between linear and logarithmic.

3. Vertical axis voltage range

Use these boxes to define the vertical axis's voltage range.

4. Time Scale

Tap this button to switch the horizontal axis scale between linear and logarithmic.

5. Horizontal axis time range

Use these boxes to define the horizontal axis's time range.

6. Nominal A-Scan

Tap this button to display or hide the nominal wall thickness A-scan (Unavailable for array probes).

7. Cursor

Tap this button to display or hide the A-scan cursor. (Not available for array probes).

8. Best Fit A-scan

Tap this button to display the Best Fit A-scan. (Unavailable for array probes).

9. Processed A-scan

Tap this button to toggle between the processed A-scan and the unprocessed A-scan. (Unavailable on single-element probes)

Current Tau-scan View Ribbon

Figure 2-16 Current Tau-scan View Ribbon

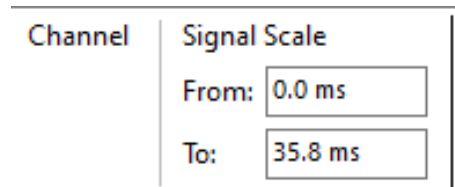

1. Vertical axis time range

Use the text boxes to define the vertical axis time range.

Current C-Scan View Ribbon

Figure 2-17 Current C-Scan View Ribbon

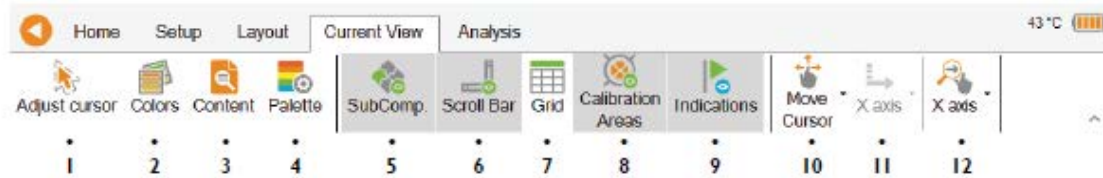

1. **Adjust Cursor**
Tap this button to resize the cursor.
2. **Colors**
Tap this button to edit the C-scan color scheme.
3. **Content**
Tap this button to zoom in on to the acquired data content in the C-scan.
4. **Palette**
Tap this button to open the **Palette Selector** dialog box.
5. **Subcomponent**
Tap this button to display or hide the subcomponent regions in the C-scan.
6. **Scroll Bar**
Tap this button to display or hide the scroll bars.
7. **Grid**
Tap this button to display or hide the C-scan grid overlay. (only available for grid mode)
8. **Calibration Point**
Tap this button to display or hide the calibration points in the C-scan.
9. **Indications**
Tap this button to display or hide indication boxes in C-scans.
10. **Move Cursor**
Tap this button to select the Lyft multi-touch display operational mode (moving the cursor, resizing).
11. **Axis selection**
When the operational mode of the multitouch display is set to resize, tap this button to select the axis to resize.
12. **Zoom mode selection**
Tap this button to select the axis along which to pinch zoom.

Current Information View Ribbon

Figure 2-18 Current Information View Ribbon

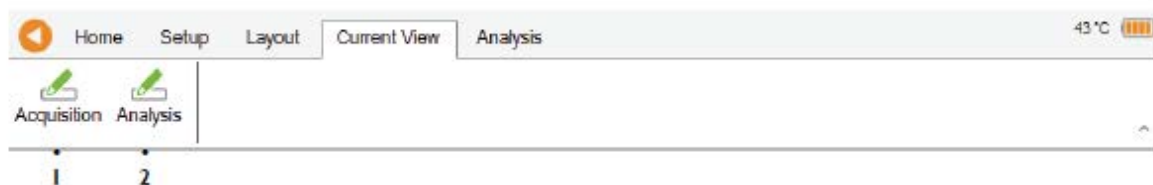

1. **Acquisition button**
Tap this button to select the different information displayed during data acquisition.
2. **Analysis button**
Tap this button to select the different information displayed during data analysis.

Analysis Ribbon

Figure 2-19 Analysis Ribbon

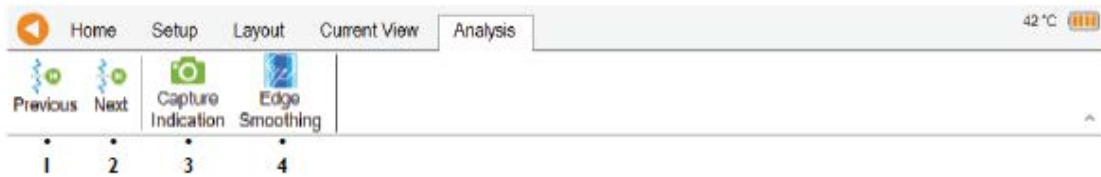

- 1. Previous**
Tap this button to select the previous defect indication recorded in the current C-scan
- 2. Next**
Tap this button to select the next defect indication recorded in the current C-scan
- 3. Capture indication**
Tap this button to capture the next defect indication recorded in the current C-scan. The screenshot is saved in the component folder as if it were created when entering the defect. The screenshot appears in the excel report.
- 4. Edge smoothing**
Tap this button to set a correction factor used to smooth out small sizing variations that can be observed on elements 1 and 6 on the array C-scan view. Only available with array probes. See Edge Smoothing menu section for more details.

Edge Smoothing menu

Figure 2-20 Edge smoothing dialog box

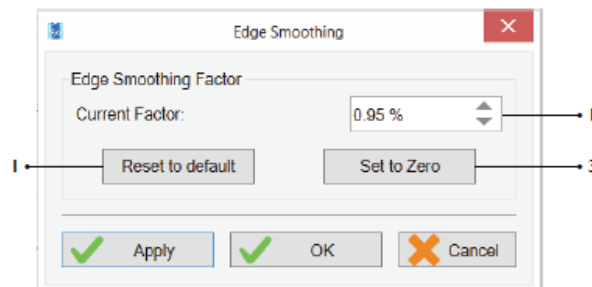

- 1. Current factor**
Currently applied correction factor used to smooth out small sizing variations that can be observed on channels 1 and 6 of the Array C-scan view.
- 2. Reset to default**
Tap this button to change the current factor to the default factor calculated for the defined component.
- 3. Set to 0**
Tap this button to change the current factor to 0%.

Chapter 3

Workflow overview

TYPICAL Inspection Workflow

Figure 3-1 Typical inspection workflow

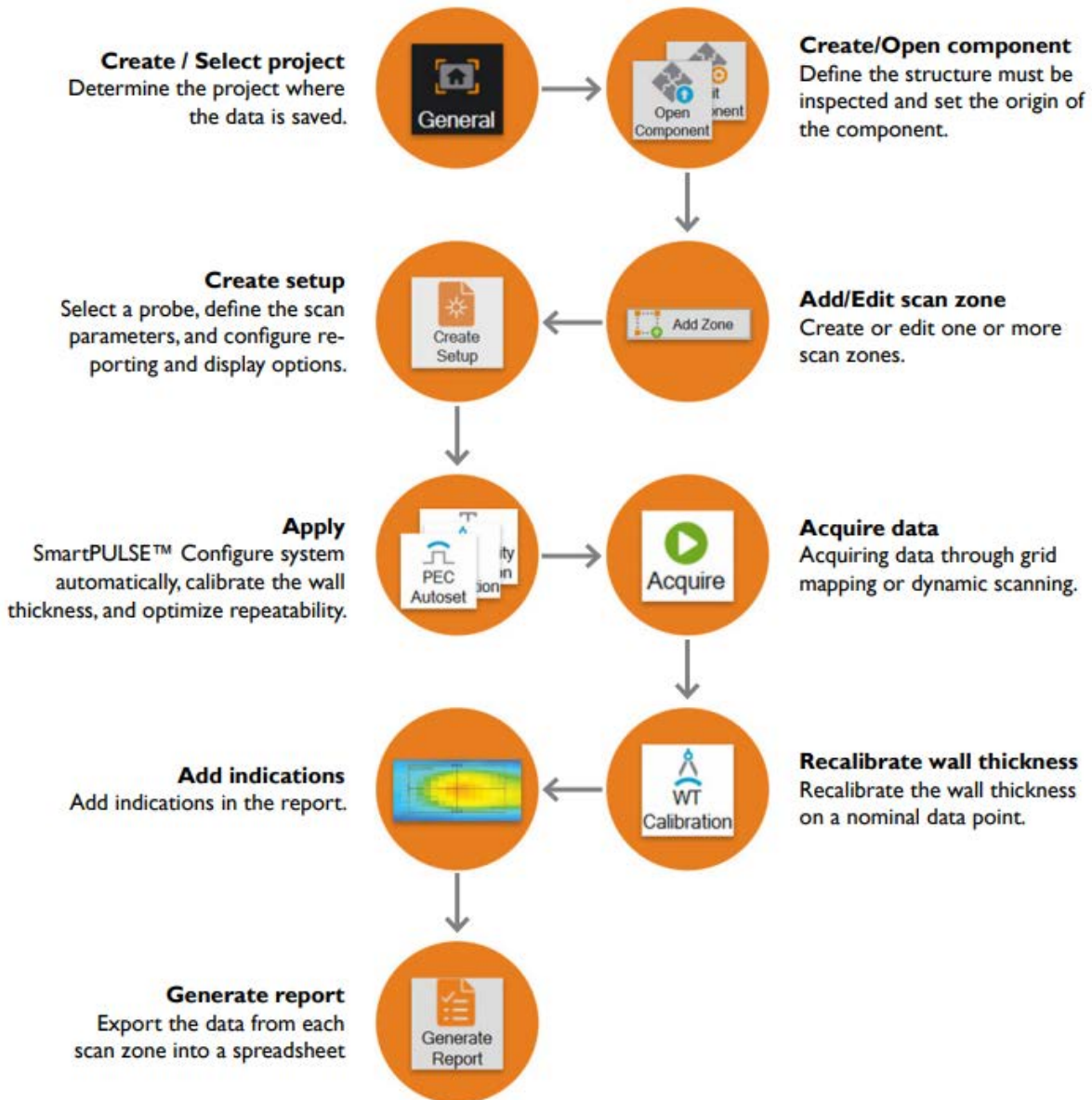

Creating / Selecting a Project

1. In the **General** section of the backstage view, tap.
The **Open** dialog box opens.

Figure 3-2 Open dialog box

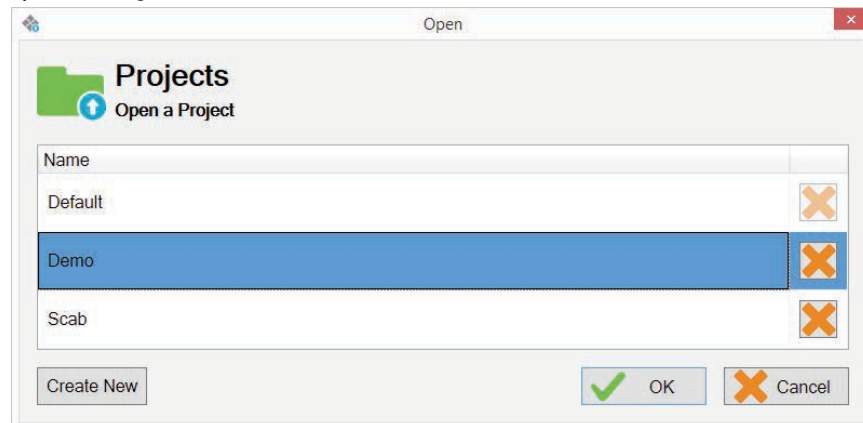

2. Tap an existing project in the project list or tap the **Create New** button to create a new inspection project.

Creating / Opening a Component

Creating a Component

1. In the **General** section of the backstage, tap the **Create Component** button.
The **Create Component Inspection** dialog box opens.

Figure 3-3 Create Component dialog box

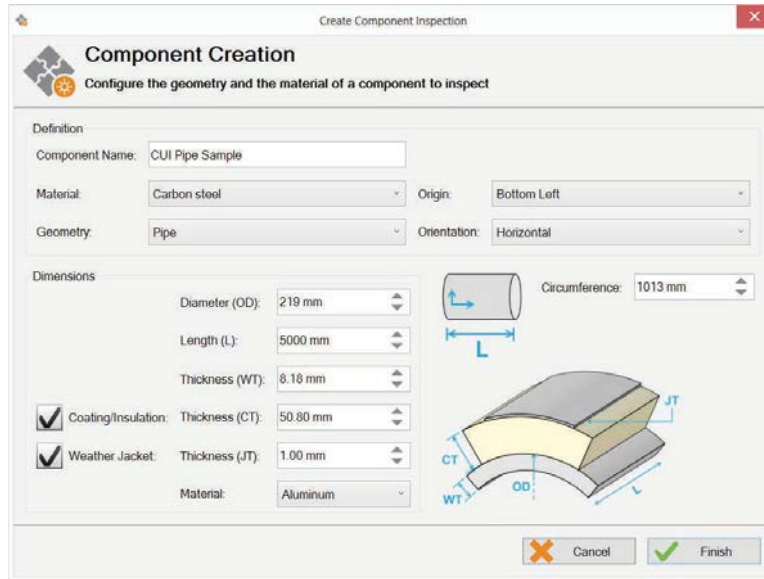

2. Specify all the necessary information, and then tap **Finish**.

Opening an Existing Component

1. In the **General** section of the backstage, tap the **Open Component** button.

The **Open** dialog box opens.

Figure 3-4 Open dialog box

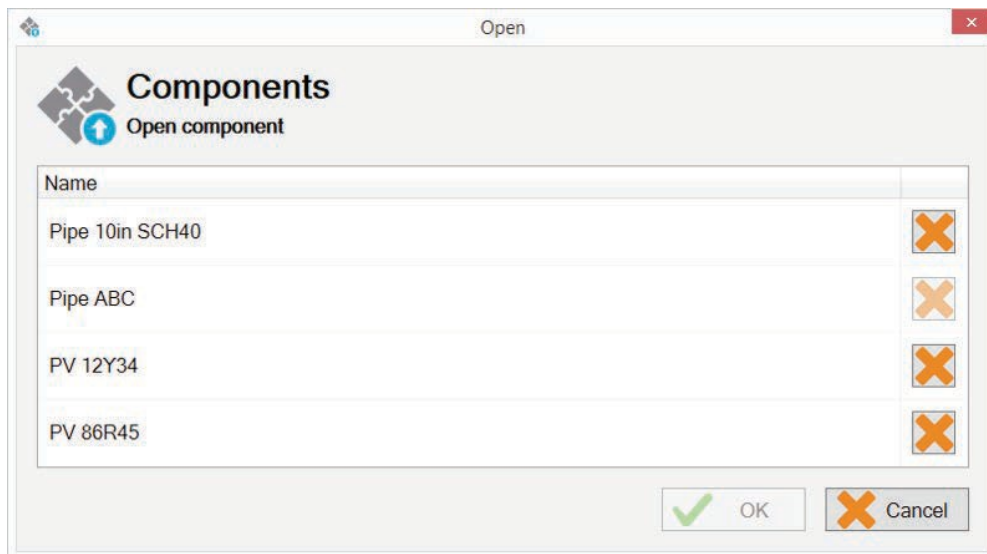

2. Tap an existing component in the list, and then tap **OK**.

Adding / Editing a Scan Zone

1. In the **Scan Area** section of the backstage, tap the **Add Zone** button.

The **Add Scan Zone** dialog box opens.

Figure 3-5 Add Scan Zone dialog box

The 'Add Scan Zone' dialog box is shown with the following settings:

- Name: Zone A
- Coordinates - Offset from Origin:
 - X axis (OX): 0 mm
 - Y axis (OY): 0 mm
- Size:
 - Width (W): 1000 mm
 - Height (H): 1000 mm

The 3D view shows a green rectangular 'Scan Zone' on a grey surface. The dimensions are labeled as W (width), H (height), OX (X-axis offset), and OY (Y-axis offset). The origin (0,0) is marked with a small orange circle at the bottom-left corner of the scan zone.

- Specify all the necessary information, and then tap **OK**.

Creating a Setup

Creating an inspection setup is achieved through a four-step wizard.

- In the **Scan Area** of the backstage, tap **Create Setup**.

The **New Setup Wizard** dialog box opens. The probe highlighted in blue is the probe currently connected to Lyft, if any. The recommended probe is indicated in the **Suggested** column.

Figure 3–6 Probe selection

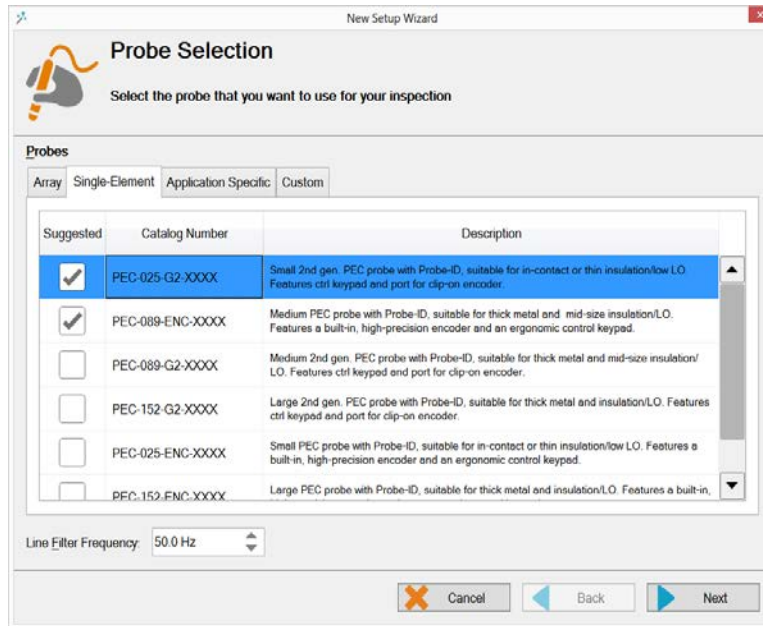

2. Connect the recommended probe to Lyft, as necessary.
3. Configure the **Line Filter Frequency** to the frequency of the power outlet.
4. Tap **Next**.

Figure 3–7 Scan definition

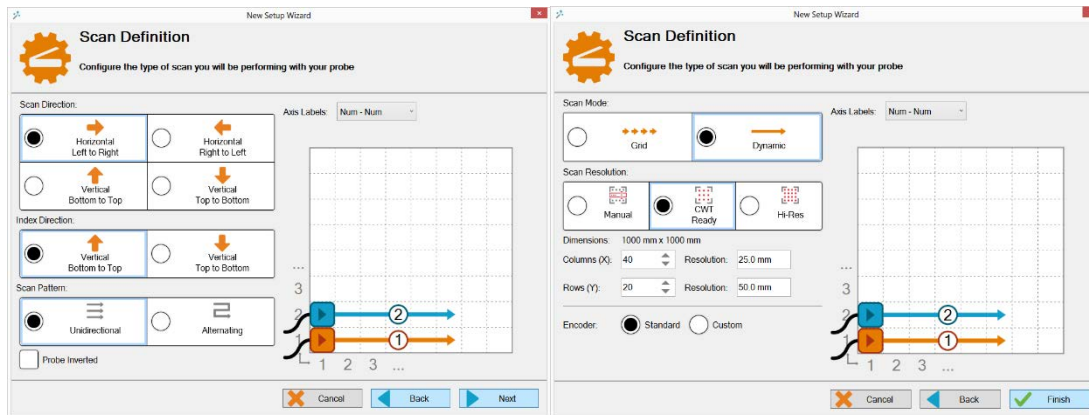

5. On the Scan Mode list, select your scan mode.

Note

There are 6 available scan modes.

In GRID mode:

- Min. for full coverage: The resolution is set at the coarsest value while still ensuring full coverage.
- CWT ready: The resolution is set to allow CWT calculation.
- Manual: resolution is set manually

In Dynamic mode:

- High resolution: a high-resolution grid resolution is proposed, based on the component geometry and probe footprint.
- CWT ready: The resolution is set to allow CWT calculation.
- Manual: resolution is set manually

Notes:

- In dynamic mode, it is possible to configure an external encoder or invert the direction of the embedded encoder.

Figure 3-8 Encoder configuration



- With array probes, the probe positioning image on the right shows the orientation of the array with respect to the scanning grid. Note that element #1 is placed near the probe cable, which is represented by the short black line on the side of the probe (see red arrow below). The probe shall be moved in the direction indicated by the arrow.

Figure 3-9 Probe positioning image

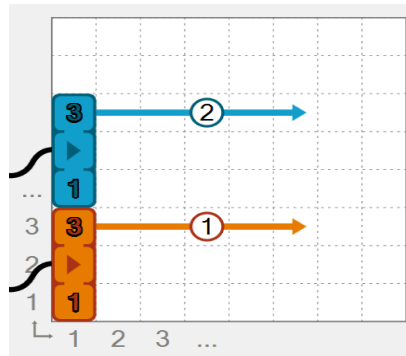

6. Tap Finish

Applying SmartPULSE™

Quick Procedure

1. In the front stage, on the **Home** or **Setup** ribbon, tap **SmartPULSE**.

Figure 3–10 SmartPULSE dialog box

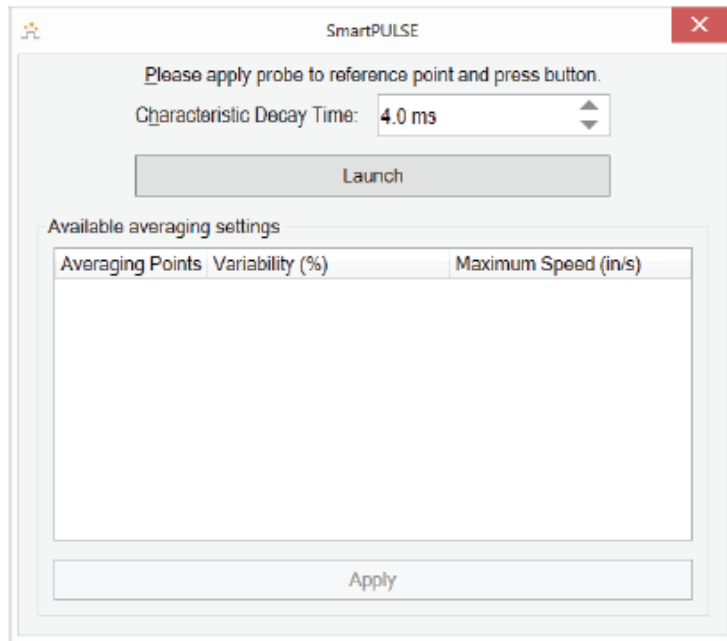

2. Place your probe on the nominal area of the component under test.
3. In the **SmartPULSE** dialog box, tap **Launch**.
4. At the end of the routine, in the **Available averaging settings** list, tap the appropriate point to reach the desired repeatability.
5. tap **Apply**.

Detailed Procedure

1. In the front stage, on the **Setup** ribbon, tap **PEC Autose**.

The **PEC Autose** dialog box opens. The **Jacket Delay** and **Characteristic Decay Time** values are configured according to your component configuration.

Figure 3–11 PEC Autoset dialog box

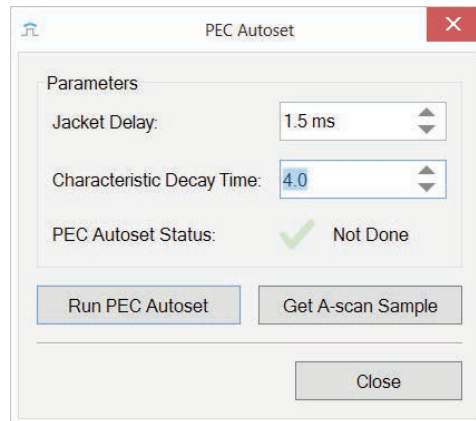

2. Place your probe on the nominal area of your component.
3. In the **PEC Autoset** dialog box, tap **Run PEC Autoset**.
4. To see the signal from your probe, tap **Get A-Scan Sample**.
5. While the probe is still on the nominal area of your component, in the front stage, on the **Setup** ribbon, tap **WT Calibration**.

The **Wall Thickness Calibration** dialog box opens.

Figure 3–12 Wall Thickness Calibration dialog box

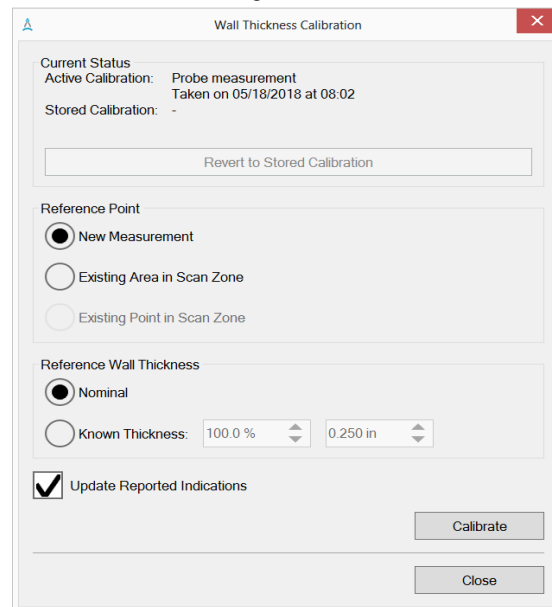

6. Select **New Measurement**.
7. Select **Nominal**.
8. Tap **Calibrate**.
9. While the probe is still on the nominal area of your component, in the front stage, on the **Setup** ribbon, tap **Repeatability Optimization**.

The **Repeatability Optimization** dialog box opens.



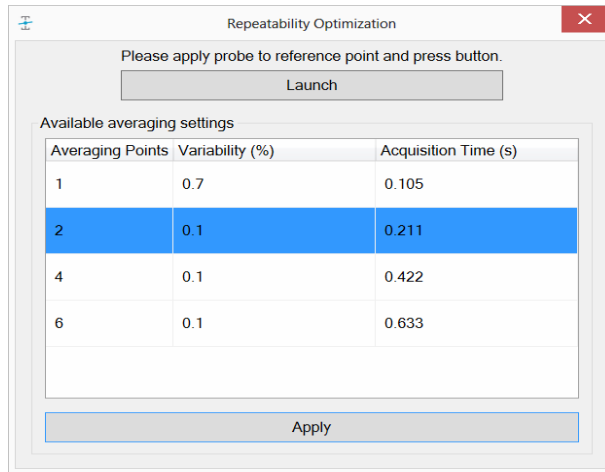





Figure 3–13 Repeatability Optimization dialog box



10. Tap **Launch**.
11. In the **Available averaging settings** list, tap the appropriate point to reach the desired repeatability, and then tap **Apply**.







Acquiring Data

Acquiring Data in Grid Mode

1. Start a data acquisition any of the following three ways:
 - Tap the **Acquire** button on the **Home** ribbon of the front stage view.
 - On Lyft, press .
 - On the probe, press .
2. Place your probe at the coordinates indicated in the information view of the front stage.
3. Measure a point any of the following three ways:
 - Tap the **Get Point** button on the **Home** ribbon of the front stage view.
 - On Lyft, press .
 - On the probe, press .
4. To move to the following index:
 - On Lyft, press  or
 - On the probe, press .
5. Stop your data acquisition any of the following three ways:
 - Tap the **Stop** button on the **Home** ribbon of the front stage view.
 - On Lyft, press .
 - On the probe, simultaneously press  and .

Acquiring Data in Dynamic Mode

1. Start a data acquisition any of the following three ways:
 - Tap the **Acquire** button on the **Home** ribbon of the front stage view.
 - On Lyft, press .

- On the probe, press  .
- 2.** Move your probe along the scan axis.
- 3.** To move to the following index:
 - On Lyft, press  or.
 - On the probe, press  .
- 4.** Stop your data acquisition any of the following three ways:
 - Tap the **Stop** button on the **Home** ribbon of the front stage view.
 - On Lyft, press  . .
 - On the probe, simultaneously press  and  .
- 5.** To temporarily pause data acquisition:
 - On the **Home** ribbon, tap **Pause Encoder**.
 - Tap again to resume acquiring data.
 - To pause acquisition, on the probe press  .
 - Press it again to resume acquisition

Recalibrating the Wall Thickness

If the initial calibration point does not correspond to the nominal value, the C-scan can be recalibrated on a different acquired point.

- 1. While the cursor is on the nominal area of your component, in the front stage, on the Setup ribbon, tap WT Calibration.

The Wall Thickness Calibration dialog box opens.

Figure 3-14 Wall Thickness Calibration dialog box

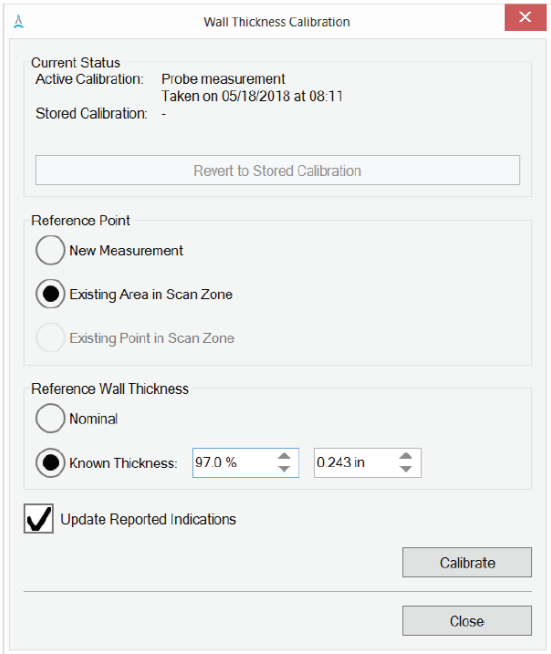

- 1. Select **Existing Area in Scan Zone** or **Existing Point in Scan Zone** (only available for single element probes).
 - To ensure a good calibration on data acquire with an array probe, the minimum calibration area size is 5 points in the index axis and 3 points in the scan axis.
- 2. Select **Nominal** to calibrate at 100 % of the wall thickness or **Known Thickness** to calibrate at a different thickness.
- 3. Tap **Calibrate**.

Adding Indications to a report

1. If there are any, discard invalid data points near the defect that you want to add.
2. Move the cursor over the target defect.

Figure 3-15 Placing cursor over target defect

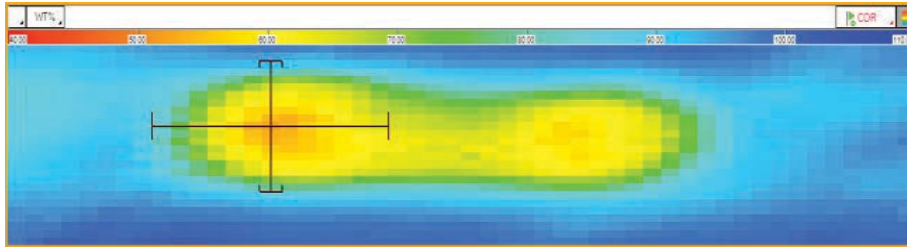

3. Resize the cursor's crosshairs so that it covers the entire defect.
4. Click **Add Indication**.
The **Add Indication** dialog box appears.

Figure 3-16 Add indication dialog box

5. On the **Indication** list, select the type of corrosion.
6. To compute the **CWT**, when available, click **Compute**.
 - If the defect is close to a feature that may affect the sizing. A flange for example. You may tap the **Mass Effect** checkbox and select the direction in which the feature is before computing the **CWT**.
7. If necessary, add a comment.
8. Click **OK**.
The defect boundaries and compensated wall thickness appear on C-scan.,

Figure 3-17 Indication added

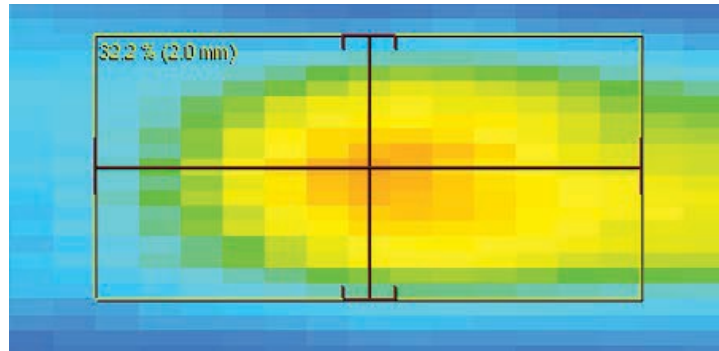

Generating a Report

1. In the General section of the backstage, tap **Generate Report**.
The Report Summary dialog box will appear.

Figure 3-18 Generate report

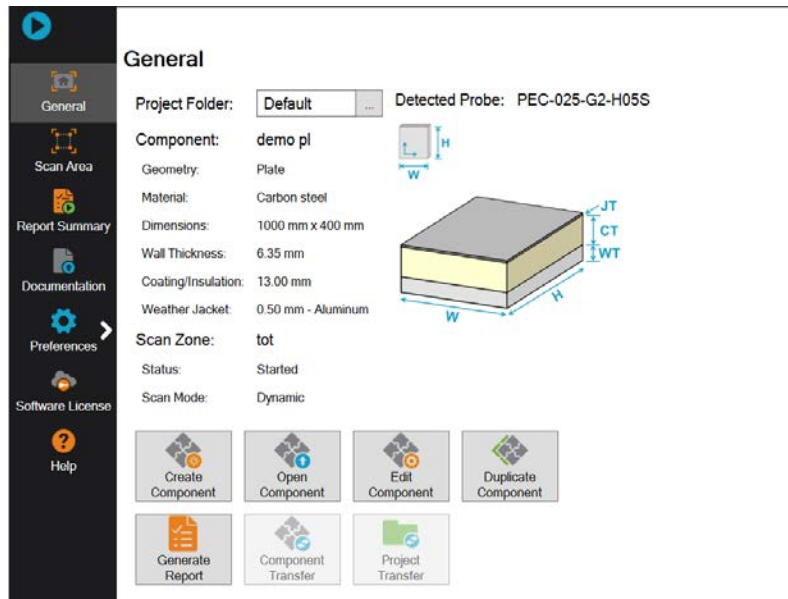

2. Type in any missing information and add comments if desired.
3. Click **Finish** to generate the report.

Figure 3–19 Generate Report dialog box

Generate Report

Report Summary

Configure the Summary Section

Client	Client ABC	X
Component Type	Insulated Pipe	X
Component S/N	98765	X
Site	Refinerie ZYX	X
Service Provider	Inspection Company DEF	X
Work Order	WO-34765	X
Procedure	PECA Inspection procedure	X
Inspector	John C	X
Analyst Comment	Richard D	X

Comments will appears in the report summary page

Add Clear Reset to Default

X Cancel ✓ Finish

Managing Data

Quick copy

1. Connect a USB mass storage device (MSD) to the **QUICK COPY** port USB on the left-hand side of the instrument.
2. Press the **QUICK COPY** button on the side of the instrument.
 - All the folders in the **Projects** folder on the Lyft instrument are copied to the USB mass storage device.
 - All the files in the **UserData** folder on the USB mass storage device are copied to the Lyft instrument.

Transferring Components

This procedure can be used to import data from a USB MSD or export data to it. The following procedure illustrates how to import data.

1. Connect a USB MSD containing a component to a USB port on the left-hand side of the instrument.
2. In the backstage, in the **General** section, tap **Component Transfer**.
The **Component Transfer** dialog box appears.

Figure 3–20 Component Transfer dialog box

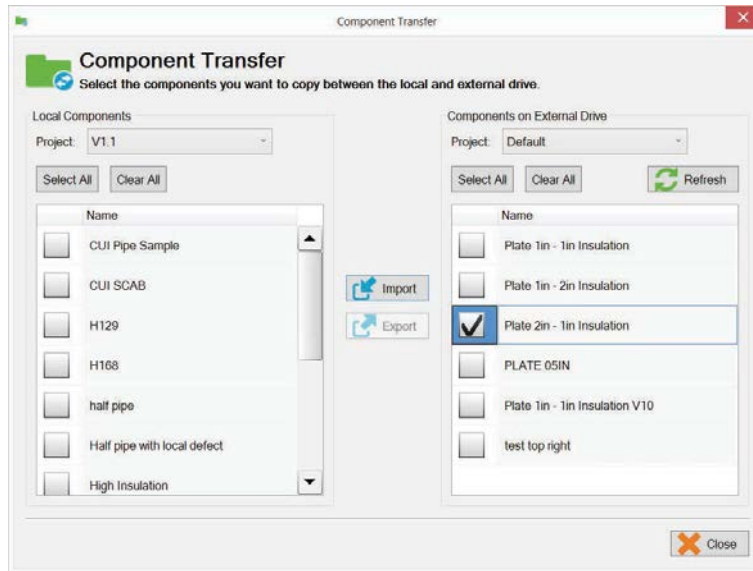

3. In the **Components on External Drive** group, select the components that you want to import to Lyft.
4. In the **Local Components** group, select the project where you want the component to be transferred.
5. Tap **Import**.

Transferring Projects

This procedure can be used to import data from a USB MSD or export data to it. The following procedure illustrates how to import data.

1. Connect a USB MSD containing a project to a USB port on the left-hand side of the instrument.
2. In the backstage, in the **General** section, tap **Project Transfer**.

The **Project Transfer** dialog box appears.

Figure 3–21 Project Transfer dialog box

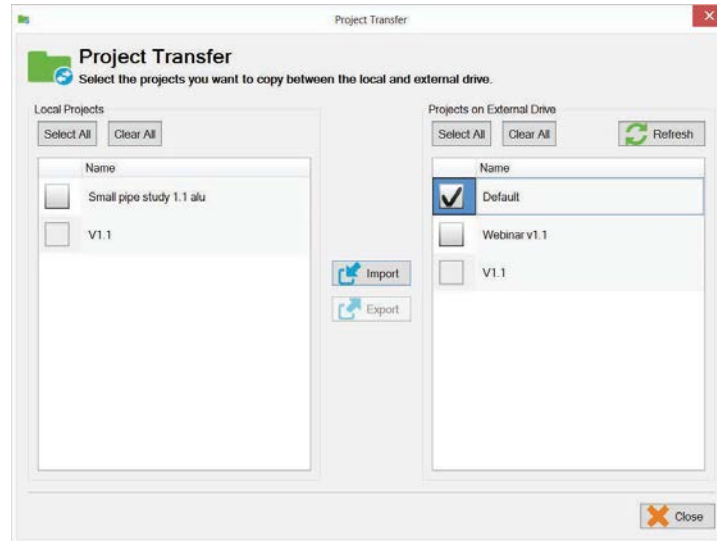

3. In the **Projects on External Drive** group, select the projects that you want to import to Lyft.
4. Tap **Import**.

Deleting All User Data

To delete all the user data on Lyft, proceed as follows:

1. Connect a USB keyboard to one of Lyft's USB ports.
2. In the backstage, tap **Help**

Figure 3-22 Help section

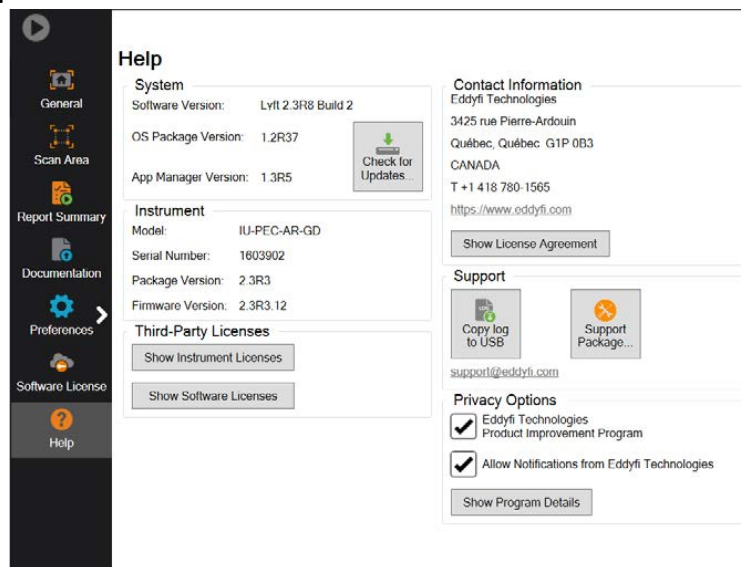

3. Tap or click inside the **Help** section.
4. On the keyboard press ALT+F2.
A confirmation dialog box appears.
5. Follow the instructions on your screen to complete the operation. All the user data is removed from the instrument.

Disabling and Enabling the Multi-Touch Display

Proceed as follows to disable and then re-enable the multi-touch display. You can perform this procedure with a USB keyboard connected to Lyft or with the keypad.

Disabling the Multi-Touch Display

1. On the Lyft keypad, long-press .
Alternatively, you can long-press K on your keyboard. A dialog box appears to prompt you to confirm whether you want to disable the multi-touch display. The display will no longer respond to touches or keyboard actions until it is re-enabled.

Enabling the Multi-Touch Display

2. On the Lyft keypad, long-press .
Alternatively, you can long-press K on your keyboard. A dialog box appears to prompt you to confirm whether you want to enable the multi-touch display. The display once again responds to touches or keyboard actions.

Remote Control Reference





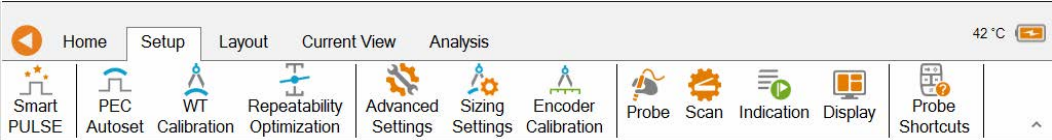





Several operations can be performed using the remote controls on PEC probes. The following summarizes all the possible functions. The Probe Shortcuts can be displayed on the instrument by tapping the Probe Shortcuts button in the Setup tab.

Figure 3-23 Setup Tab









Analysis Mode

Table 3-1 Analysis mode remote control reference

Keypad Function	Operation
	Moves to the next point on the scan axis.
	Moves to the previous point on the scan axis.
	Moves to the next point on the index axis.
	Moves to the previous point on the index axis.
	Initiates the acquisition in analysis mode.
	Initiates the survey mode.
	Opens the SmartPULSE dialog box.
	Opens the PEC Autoset dialog box in analysis mode.
	Opens the WT Calibration dialog box in analysis mode.
	Opens the Repeatability Optimization dialog box in analysis mode.





Grid Mapping Data Acquisition

Table 3-2 Grid mapping data acquisition remote control reference

Keypad	Operation
	Acquires a data point at the current cursor
	Moves to the next acquisition point as defined in the scan parameters on the scan axis (may not be the same direction as the movement of the probe).
	Moves to the previous acquisition point as defined in the scan parameters on the scan axis (may not be the same direction as the movement of the probe).
	Moves to the next acquisition point as defined in the scan parameters on the index axis (may not be the same direction as the movement of the probe).
	Moves to the previous acquisition point as defined in the scan parameters on the index axis (may not be the same direction as the movement of the probe).
	Reverses the direction of the grid mapping data acquisition.
	Stops the acquisition mode. Returns to the analysis





Dynamic Mode Data Acquisition

Table 3-3 Dynamic mode data acquisition remote control reference

Keypad	Operation
	Pause (first press) and resume (second press) the acquisition process.
	Moves to the next acquisition point as defined in the scan parameters on the index axis (may not be the same direction as the movement of the probe).
	Moves to the previous acquisition point as defined in the scan parameters on the index axis (may not be the same direction as the movement of the probe).
	Stops the acquisition mode. Returns to the analysis mode.

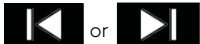

SmartPULSE

Table 3-4 SmartPULSE remote control reference

Keypad	Operation
	Starts
	Aborts SmartPULSE.
	Moves up or down in the table to select the appropriate averaging value.
	Applies the selected averaging value and closes the SmartPULSE dialog box.
	Closes the SmartPULSE dialog box without selecting the averaging value.





Survey Mode

Table 3-5 Survey mode remote control reference

Keypad	Operation
	Acquires a data point to memory showing results in the A-scan and information zone only
	Stops the survey mode.









PEC Autoset

Table 3-6 PEC Autoset remote control reference

Keypad	Operation
	Starts the PEC Autoset
	Aborts the PEC Autoset routine.
	Acquires an A-scan
	Closes the PEC Autoset dialog box. Returns to the analysis mode.





Wall Thickness Calibration

Table 3-7 Wall thickness calibration remote control reference

Keypad	Operation
	Starts the wall thickness calibration with a new measurement (default setting).
	Starts a wall thickness calibration with the currently selected area.
	Moves to the next point on the scan
	Moves to the previous point on the scan axis.
	Moves to the next point on the index
	Moves to the previous point on the index axis.
	Aborts the wall thickness calibration
	Closes the WT Calibration dialog box. Returns to the analysis mode.

Repeatability Optimization

Table 3-8 Repeatability optimization remote control reference

Keypad	Operation
	Starts the repeatability optimization
	Aborts the repeatability optimization process.
	Moves up or down in the table to select the appropriate averaging value.
	Applies the selected averaging value and closes the Repeatability Optimization dialog box.
	Closes the Repeatability Optimization dialog box without selecting a new averaging value. Returns to the

Chapter 4

Lyft PRO software

Lyft Pro

Lyft Pro enables advanced Lyft data analysis and features the same graphical user interface than the Lyft embedded software. The software takes advantage of the power of a workstation and offers features like wireless transfer, calibration propagation, and compensated wall thickness C-scans.

Transfer Data from Lyft to a computer

The data captured with the Lyft instrument can be transferred to Lyft PRO on the PC in two ways:

1. Using a USB key, as explained in Managing Data on page 45
2. Connecting the Lyft instrument to Lyft PRO through a Wi-Fi interface or ethernet cable.

For this second method to work, the Wi-Fi interface of the Lyft instrument must be enabled and the Lyft PRO PC and Lyft instrument must be connected to the same Wi-Fi network.

Alternatively, the instrument can be connected directly to the PC or local network via an ethernet cable.

Importing Data from Lyft Pro Over a Wireless Network

Start Lyft PRO and select the General backstage window. Click on either Component Transfer or Project Transfer (see section Managing Data on page 45). If Lyft PRO detects any Lyft instrument on the Wi-Fi network, the following window is shown:

Figure 4-1 External Path Selection dialog box

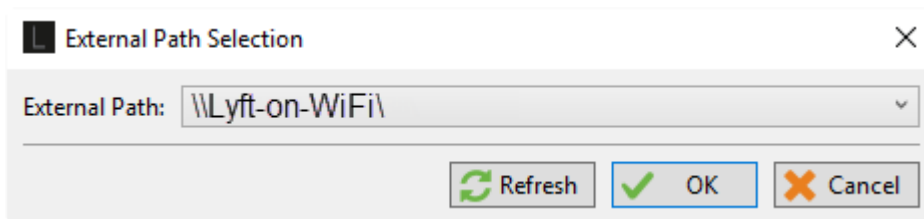

Clicking on the drop-down menu, all the available Lyft instruments are shown and one can be chosen. The refresh button updates the list of available Lyft instruments.

Click OK when the appropriate Lyft is selected. The Project Transfer or the Component transfer windows are shown. In Figure 4-1 The “external drive” list refers to the data stored on the Wi-Fi-connected Lyft.

The Component Transfer and Project Transfer windows work as explained in Managing Data on page 45.

Propagating Calibrations with Lyft Pro

Use the Lyft Pro propagate calibration feature to apply one scan zone calibration to other scan zones, created with **Duplicate Scan Zone** (see Scan Area Section on page 17)

1. In the Scan Area section of the backstage, select and load a scan zone with the calibration you want to apply to other scan zones of the same component. Click Propagate Calibration.

Figure 4–2 Scan Area section

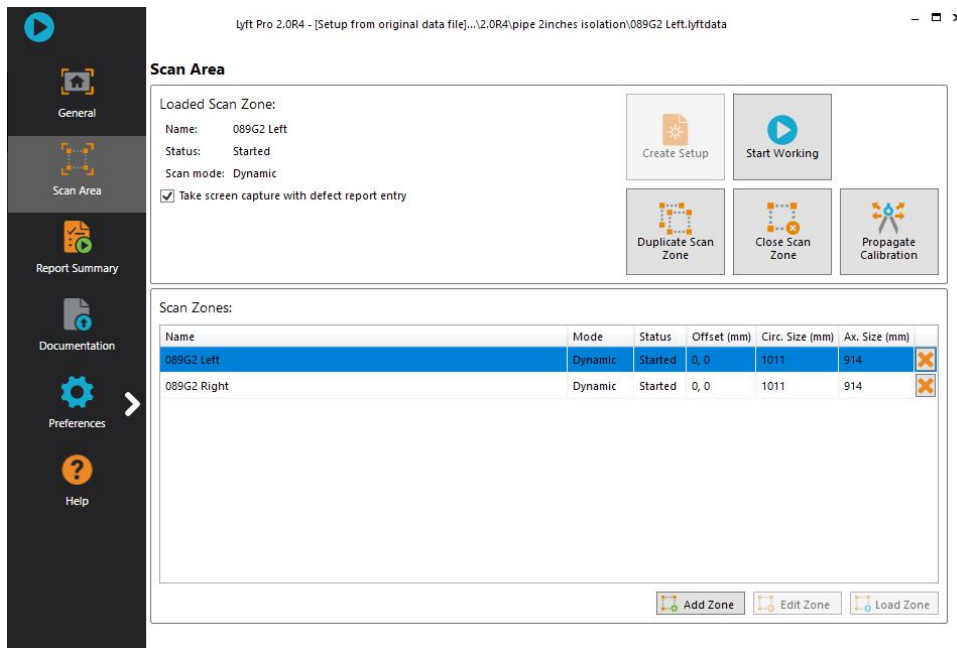

The **Calibration Propagation** dialog box appears

2. Select the target scan zones

Figure 4–3 Calibration Propagation dialog box

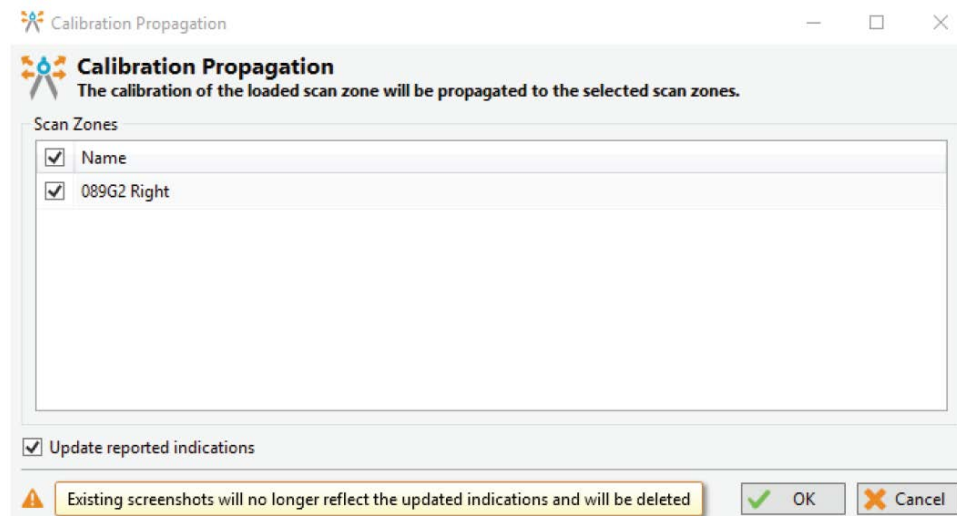

3. When the **Update reported indications** check box is selected, compensated wall thickness values are recalculated based on the new calibration

4. To start the process, click **OK**.

Compensated wall thickness C-scan

In Lyft and in Lyft PRO, the C-scan can show several different values (click on the icon on top-left of the C-scan to select the desired output):

- WT%: remaining wall thickness in % referenced to the nominal wall thickness
- WT: remaining wall thickness in absolute units
- WL%: wall loss in % referenced to the nominal wall thickness
- CWT% (available only in Lyft PRO): compensated remaining wall thickness in % referenced to the nominal wall thickness.

Figure 4-4 Selecting the C-scan

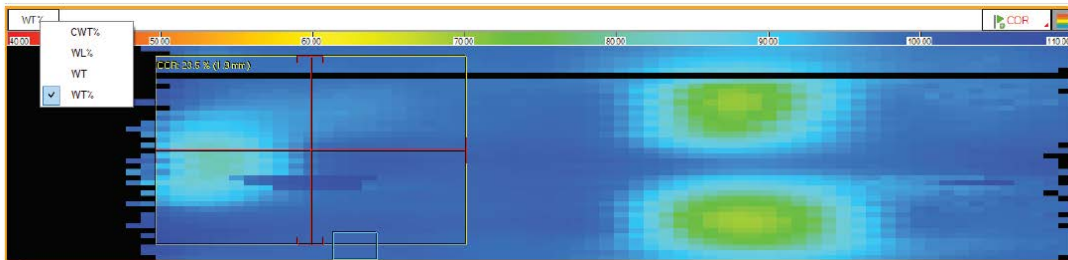

The CWT% C-scan is a processed C-scan with colors adjusted to scale the minimum remaining wall thickness of a defect to the value found by the CWT tool. For example, the CWT value for the defect show above is 45.5%, while the Cscan shows greenish colors corresponding to about 85%. The CWT% Cscan shows the defect minimum wall in reddish colors which are more representative of the true remaining thickness (with the standard palette). The CWT% Cscan looks as following:

Figure 4-5 CWT% C-scan

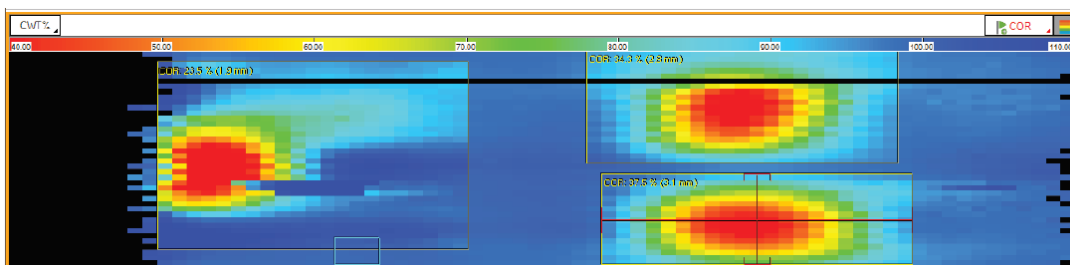

The CWT% C-scan is also included in the Excel Report when generated in Lyft PRO (see section Generating a Report on page 44).

Chapter 5

Preferences

Managing Preferences

Figure 5-1 System preferences

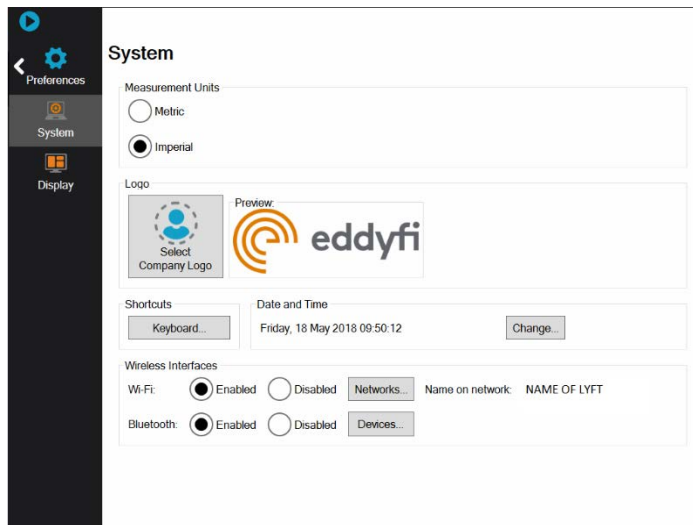

Measurement Units

You can use Lyft under the US Customary (imperial) or metric system of measurement units. To change measurement unit system, tap **Imperial** or **Metric**. When you do, measurement units are adjusted across the software and in your reports.

Company Logo

1. See Managing Data on page 45 to find out how to import your logo to the Lyft instrument
2. Tap **Select Company Logo**.
3. Select the logo file, and then tap **OK**

Figure 5-2 Selecting a logo



Adjusting the Date and Time of the Lyft Instrument

In the **System** preference section of the backstage, tap **Change**. A dialog box appears where you can adjust the date, time, and time zone to match requirements.

Connecting a Lyft Instrument to a Wi-Fi Network

1. In the **System** preference section of the backstage, tap **Networks**.

A dialog box showing all available wireless networks appears

Figure 5–3 System preferences



2. Tap the desired network
3. Tap **Connect**
4. Input the appropriate user name and password, and then tap **OK**

Figure 5–4 Wi-Fi Networks dialog box

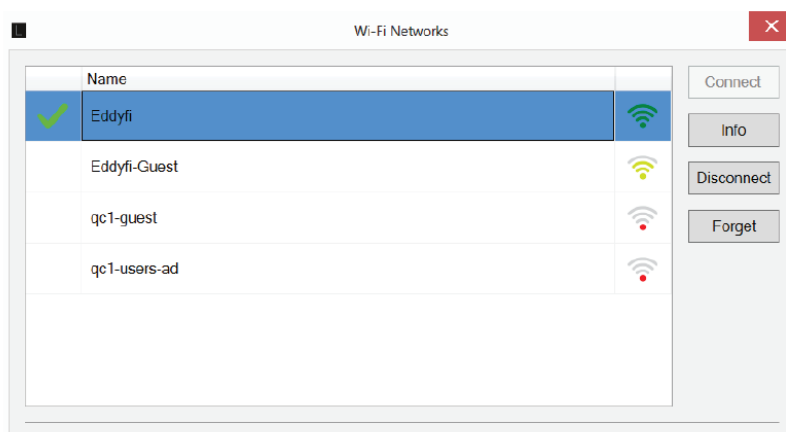

Note

Tap **Disconnect** to break the connection to the wireless network. Tap **Forget** to remove the login information of the selected wireless network..

Display Preferences

In the **Display** preferences section of the backstage, you can configure a sleep delay of 1 to 30 minutes. By default, the sleep delay is 15 minutes. If active, once this delay expires, the display turns off and the power LED goes from green to red.

Figure 5-5 Display preferences

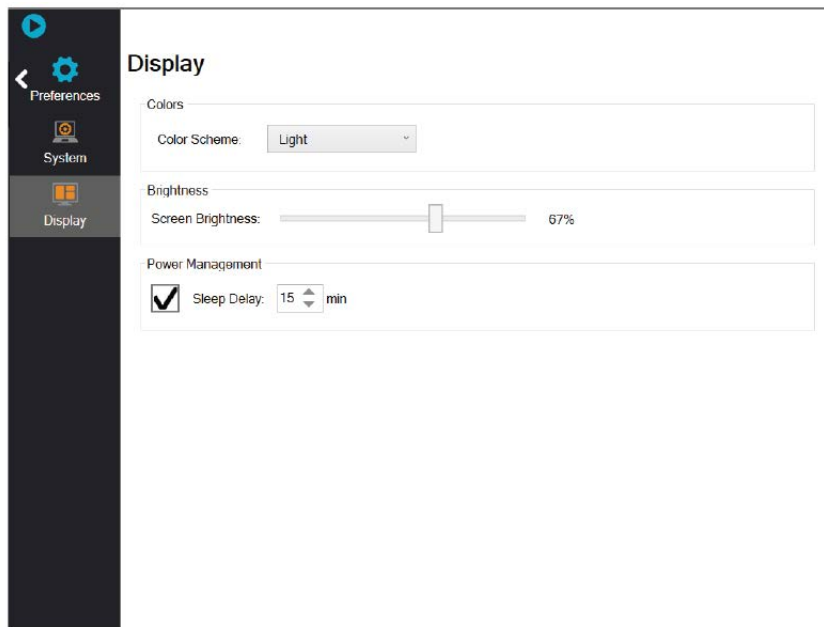

To exit the sleep mode, short press the power button, touch the display, or press any of the other keypad buttons.

Chapter 6

Keypad and Keyboard Functions

Keyboard Shortcut Keys

The following table lists all the keyboard shortcuts for Lyft®. When you are using a physical keyboard with the instrument, you can achieve the same results as with the Lyft keypads by using those keyboards shortcuts. These keyboard shortcuts are not editable.

Table 6-1 Keyboard shortcut keys

Keypad Function	Keyboard Shortcut
Left arrow	Left arrow key
Up arrow	Up arrow key
Right arrow	Right arrow key
Down arrow	Down arrow key
Start/Stop acquisition	F2
Keypad arrow mode selection	F3
Change active view	alt+F7
Maximize/Minimize view	alt+F8
Quick Copy	alt+F9
Exit Lyft software	alt+F10
Wall thickness calibration	alt+F11
Change layout	F11
Enter	Enter

Further keyboard shortcuts are available and editable from the Keyboard Shortcuts menu for both Lyft and Lyft PRO. To access it, tap the **Keyboard** button in the **Preferences – System** page of the Backstage.

Figure 6-1 Keyboard Shortcuts dialog box

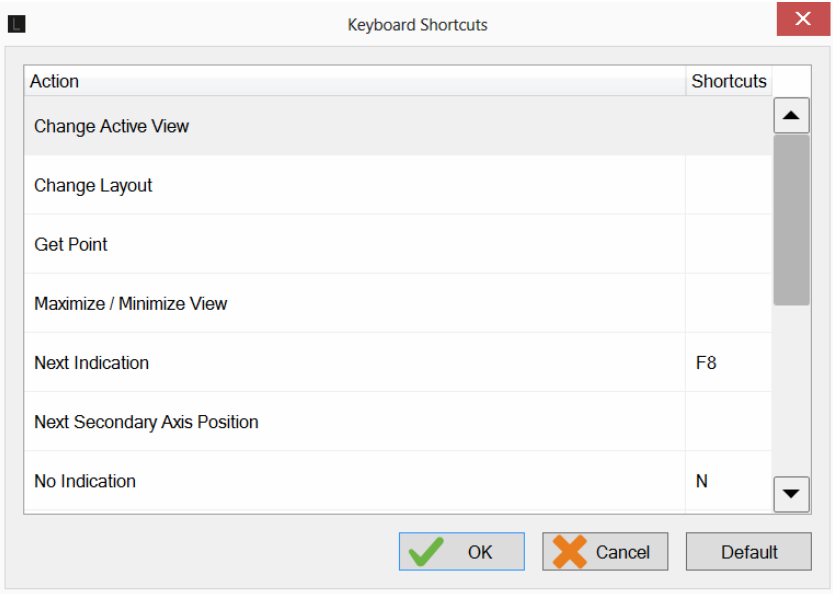

Chapter 7

Maintenance and Troubleshooting

Maintaining Lyft

Because of its design, Lyft® only requires minimal maintenance. Since Lyft has no moving parts, it also does not require any preventive maintenance on your part. We recommend a regular inspection of the instrument to ensure that it is properly grounded. We also strongly recommend an annual calibration and a factory-performed preventive maintenance by an officially qualified Eddyfi technician.

Cleaning Lyft

1. Make sure that the instrument is off and that the power cord is disconnected.
2. To bring the instrument back to its original finish, clean it with a soft cloth.



Warning

Do not spray the instrument with chemical cleansers or water. Doing so may lead to short circuits and damage to the instrument.

Important

To remove stubborn stains, use a cloth moistened with soft, soapy solution. Do not use abrasives or strong solvents as they could damage the finish. Wait until the instrument is completely dry before connecting the power cord or cables.

Clip-on Encoder

You should take the following precautions when using the clip-on encoder:

- Completely insert the encoder until you feel it click into place.
- Keep electrical contacts clean of dirt and dust.
- Avoid direct impacts on the encoder arm.

The clip-on encoder is designed to survive 1m (3.3 ft) drops, even when attached to a probe. In case of a drop or shock, the encoder arm is designed to detach from the plastic body to avoid permanent failures. The arm is attached to the body with a small clamp ring. A set of five replacement clamp rings and one ring plier tool are included in the Lyft box.

Replacing the Clamp Ring

Following an impact on the encoder, the clamp ring on the encoder arm shaft may fall or be damaged. Follow this procedure to replace the clamp ring with a replacement one provided with the instrument.

1. Gather the require material:
 - Damaged encoder
 - One replacement clamp ring
 - Supplied pliers

Figure 7-1 Encoder and replacement clamp ring



2. Make sure that the pliers are in the “Expanding” configuration as in the following picture. This means that bringing the pliers handles closer to one another drives away the pins from one another.

Figure 7-2 Pliers in expanding configuration

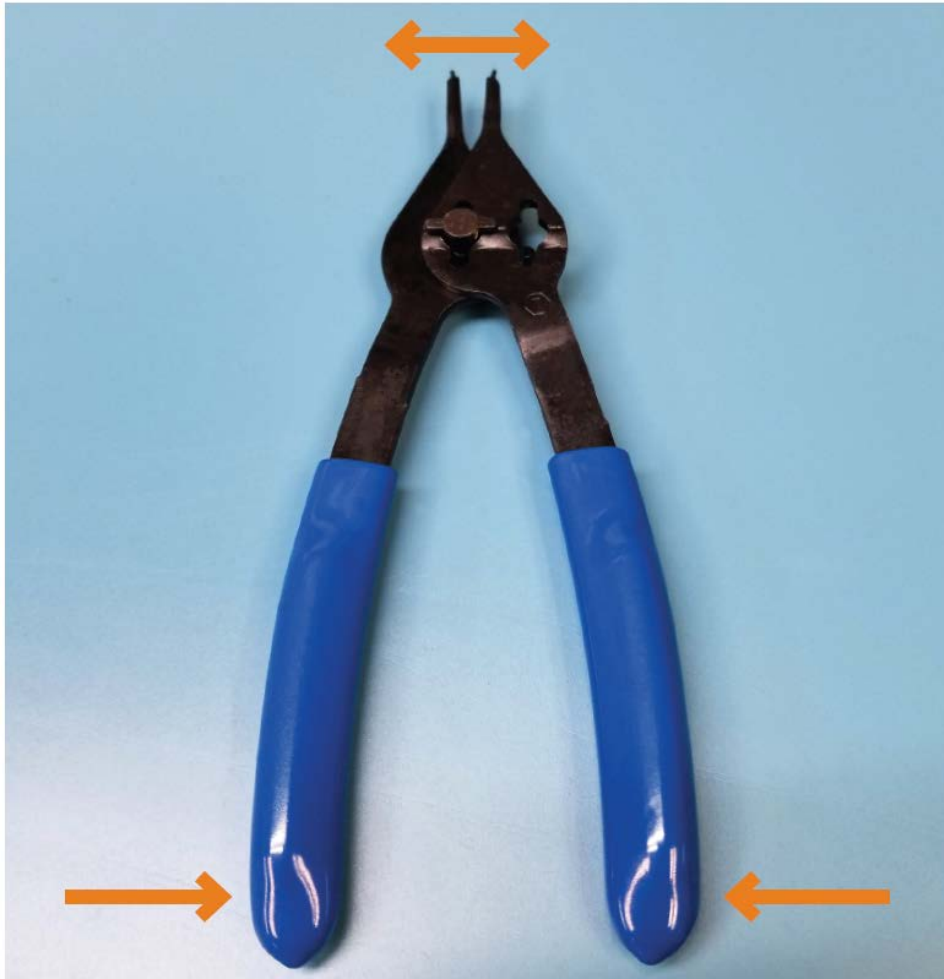

3. Insert the pins of the pliers inside the replacement camp ring holes. For an easier installation, make sure the ring sits on the extremities of the pin. This will make the installation easier later on.

Figure 7-3 Clamp ring sitting on plier



4. Push the encoder connector on the shaft toward the encoder arm. Expand lightly the clamp and install it on the encoder shaft delicately.

Figure 7-4 Clamp ring installation



5. Make sure that the retaining clamp is well seated in its groove.

Using Second-Generation Probes Without an Encoder

Do not leave the clip-on encoder connector of second-generation single-element probes exposed to dust and dirt. If you are not using the clip-on encoder, cover the protective cap supplied with the probe.

Figure 7-5 Clip-on encoder protective cap

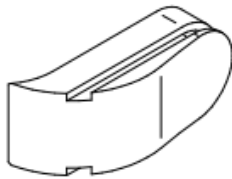

Updating and Upgrading Software

Before you can perform any maintenance on the software, you must first meet the following requirements:

- USB mass storage device with a minimum of 4 GB free space
- Hardwired Internet connection

There are two ways of updating or upgrading the software.

Standard

1. Connect Lyft to a power outlet with the power cable.
2. Turn on Lyft and wait for the software to start.
3. Download the *.LyftUpdate file from the Eddyfi Web site.
Save the file in an easy-to-remember location on your computer.
4. Copy the *.LyftUpdate to the root of a USB mass storage device.
5. Once copied, remove the mass storage device and connect it to one of Lyft's two USB ports. A dialog box appears to prompt you to proceed.

Important

Do not connect your mass storage device to the QUICK COPY USB port.

6. Tap **Yes**.
7. In the list that appears, tap the desired update file, and then tap **Update**.

Important

If you are performing a complete Lyft OS update, perform steps 8 to 10. In the case of a software update, the instrument restarts automatically.

Figure 7-6 Update dialog box

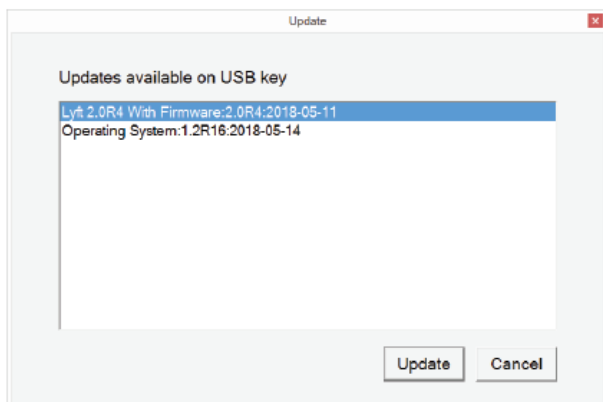

8. For **Yes**, press the keypad's up arrow.
For **No**, press any other button. You are prompted to confirm again.
9. Press the keypad's up arrow again.
The update process starts. This normally takes between 5 and 10 minute, depending on the speed of your mass storage device. When the process is complete, the system restarts.
10. Activate Windows.
See Activating Windows on page 72 for details.

System Recovery Method (Factory reset)

Important Note on System Recovery

Before starting the system recovery, check the Lyft Calibration Date on the Calibration Seal attached to the back of the instrument. If the latest Calibration dates before April 2020, please contact Eddyfi (info@eddyfi.com) before executing the System Recovery procedure.

1. Connect Lyft to a power outlet with the power cable.
2. Make sure that Lyft is off. If it is not, turn it off.
3. Turn on the instrument.
4. Immediately and simultaneously press the get point button and the change layout button (see page 2) until the following appears.

Figure 7-7 Options menu



5. With the keypad arrows, select **Enter Eddyfi System Recovery**, and then press the Enter button (see page 2).
You are prompted to wait until the following appears.

Figure 7-8 System recovery interface

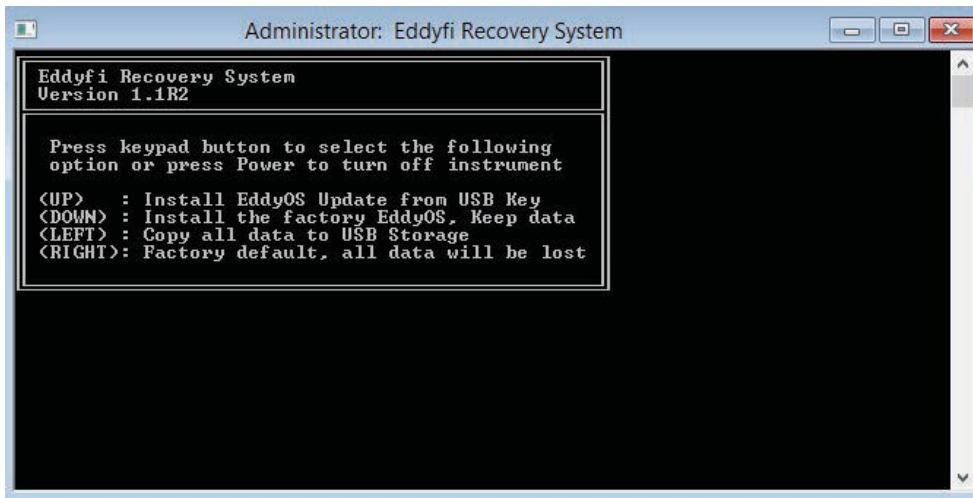

6. Using the keypad arrows, select **Install the factory EddyOS update, keep data**.
7. When prompted, press the up arrow of the keypad.
The update process starts. This normally takes between 5 and 10 minutes. When the process is complete, the system restarts.
8. Activate Windows.
See Activating Windows in the next section for details.

Activating Windows

Microsoft requires that you activate Windows to be able to use it. The activation process is automatic when you connect Lyft to the Internet through an Ethernet cable. To proceed :

1. Make sure that Lyft is on and that the software is running.
2. Connect an Ethernet cable to Lyft.
3. Connect the other end of your Ethernet cable to a network (local area network or other access point).
4. Wait until a dialog box confirming the activation of Windows appears on screen. If you do not activate Windows, every time you start Lyft, a message will remind you to do so. You have 30 days to activate Windows before it locks up.

Known Issue With System Updates/Upgrades

On some units, a blue Windows error screen may appear when you attempt to enter the system recovery, which can cause the unit to start normally. Try performing the update procedure again.

Troubleshooting

Troubleshooting System Updates/Upgrades

No update file found

This appears in the update list or in the system recovery. Make sure that you only have one USB mass storage device connected to Lyft. Also make sure that the file is in the root folder of the device.

Cannot display the options screen.

You did not press and hold the get point button and the change layout button (see page 2) long enough

- You did not press and hold the correct buttons
- You did not press and hold the buttons quickly enough after turning on Lyft

Try holding the power button for two seconds, and then quickly pressing and holding the get point button and the change layout button.

Using the system recovery method, Lyft restarted normally or a blue error screen appeared on the screen

Perform the procedure again

Unable to activate windows

1. Make sure your Ethernet cable is sound.
3. Make sure that you have Internet access.
4. Make sure you are using DHCP.
5. After connecting the Ethernet cable and to the network, turn on Lyft.

If you do not see a message warning you Windows is not activated when it starts, Windows is activated.

Chapter 8

Specifications

General

Table 8-1 General specifications

Specification		Value
Dimensions (W×H×D)		355×288×127 mm (14.0×11.3×5.0 in)
Weight	With batteries	6.6 kg (14.5 lb)
	Without batteries	5.7 kg (12.5 lb)
Volume		13 L (791 in ³)
Power requirements		100–240VAC ±10 % 50–60 Hz
Power supply		Direct VAC (100 W) or onboard batteries
Maximum input current		1.5A
Batteries	Type	Rechargeable lithium-ion, DOT compliant 6–8 hours (with both batteries in instrument)
	Typical life	
Display		26.4 cm (10.4 in) Non-reflective (AR coating) Anti-fingerprint (oleophobic coating) 3 mm (1/8 in), chemically strengthened glass cover Optically bonded LCD and touchscreen Passive backlight enhancement
Video output		HDMI
Storage		SSD, 100 GB
Cooling		Sealed and fanless
Encoders		2 axes, quadrature
Connectivity		Gigabit Ethernet, Wi-Fi, Bluetooth®, USB 2.0 (×3)
Probe recognition and setup		Automatic

Environmental

Table 8-2 Environmental specifications

Specification		Value
IP rating	Designed for IP65	
Operating temperature	0–40 °C (32–104 °F)	
Operating humidity	95 %, non-condensing	
Storage temperature	–20–60 °C (–4–140 °F)	
Storage humidity	95 %, non-condensing	
Compliance	ASME, EN 61010-1, CE, WEEE, FCC Part 15B, ICES-003, AS/NZS CISPR 22, RoHS	

Probes

Table 8-3 Single-element probes specifications

Specification	Value
Models	Liftoffs: 0-305 mm (0-12in), 0-203 mm (0-8 in), 0-76 mm (0-3 in) Clip-on encoder Remote control keypad Lyft 27-pin Fischer connector Heavy-Duty 5m (16.4 ft) cable
Testing temperatures	Carbon steel structures: -150°C to 500°C (-238°F to 932°F) Weather jackets: maximum 70°C (158°F)
Accessories	Extension cable, from 15 m (50 ft) to 100m (328f) Telescopic extension pole with embedded remote control keypad, up to 4.6 m (15 ft) long See page 7 and the PEC probe catalog for further details

Table 8-4 Array probes specifications

Specification	Value
Models	Liftoffs: 0-50 mm (0-2in) Clip-on encoder Remote control keypad Lyft 27-pin Fischer connector Heavy-Duty 5m (16.4 ft) cable
Testing temperatures	Carbon steel structures: -150°C to 500°C (-238°F to 932°F) Weather jackets: maximum 70°C (158°F)
Accessories	Extension cable, from 15 m (50 ft) to 100m (328f) Scab mat for constant liftoff See page 9 and the PEC probe catalog for further details

Performances

Table 8-5 Performances

Specification	Value
Nominal wall thickness	Up to 100 mm (4 in)
Insulation (liftoff)	0-305 mm (0-12 in)
Dynamic data acquisition	Up to 15 points/s (GD and GDA models only)
Dynamic scan speed	Up to 75 mm/s (3 in/s) (GD and GDA models only)
Grid-mapping scan speed	Instant, less than 1 second (typical)
Smallest detectable defect volume	15 % of footprint volume (footprint × WT)
Minimum measurable remaining WT	15 % from nominal
Pipe diameter	Down to 25 mm (1 in)
Weather jackets	<ul style="list-style-type: none"> Stainless steel up to 1.5 mm (0.06 in) Aluminum up to 1 mm (0.04 in) Galvanized steel up to 0.5 mm (0.02 in)
SmartPULSE	<ul style="list-style-type: none"> Automatic configuration of PEC pulser-receiver parameters Full thickness sensitivity (OD and ID flaw detection) Reliable measurements with liftoff variations, weather jackets overlaps, straps, and corrosion scabs One-point calibration (on nominal wall or known thickness value), auto-normalization, and repeatability optimization

Appendix A

Connector reference

PEC Connector

The 27-pin connector available on the right side of the instrument, marked PEC, is specifically designed by Eddyfi. For details about this connector, contact Eddyfi directly at info@eddyfi.com.

I/O Connector

The I/O connector allows the instrument to send and receive various signals such as the acquisition start and stop commands, the encoder and rotation synchronization signals, the relay outputs, etc.

Table A-1 I/O connector data

Number of contacts	12, female
Manufacturer P/N	Fischer DBPU 1031 A012-130
Eddyfi P/N	MACN4090
Suggested cable connector	Fischer S 1031 A012-142+ Eddyfi MACN0238

Table A-2 I/O connector pinout

Pin	Signal	Description
1	+5VEXT_2	+5 V supply output
2	ENC1_PHA	Encoder phase A axis 1
3	ENC1_PHB	Encoder phase B axis 1
4	ENC2_PHA	Encoder phase A axis 2
5	ENC2_PHB	Encoder phase B axis 2
6	IN	Reserved
7	IN	Reserved
8	IN	Reserved
9	IN	Reserved
10	GND	Ground
11	OUT	Reserved
12	OUT	Reserved

Ethernet Connector

The Ethernet connector is used to connect the Lyft to a network through an Ethernet link. Eddyfi supplies a high-quality, military-grade Ethernet connector and cable. International Ethernet standards are used.

Table A-3 Ethernet connector data

Type	RJ45, female
Manufacturer P/N	PEI Genesis, Amphenol RJF2200SCC
Eddyfi P/N	MACN4016

Table A-4 Ethernet connector pinout

Pin	I/O	Signal	Description
1	Bidirectional	Bi_DA+	Bidirectional pair A+
2	Bidirectional	Bi_DA-	Bidirectional pair A-
3	Bidirectional	Bi_DB+	Bidirectional pair B+
4	Bidirectional	Bi_DC+	Bidirectional pair C+
5	Bidirectional	Bi_DC-	Bidirectional pair C-
6	Bidirectional	Bi_DB-	Bidirectional pair B-
7	Bidirectional	Bi_DD+	Bidirectional pair D+
8	Bidirectional	Bi_DD-	Bidirectional pair D-

Important

Lyft must be linked to a workstation with a category 5e, shielded, Ethernet cable or better of a maximum length of 100 m (328 ft).

HDMI Connector

The HDMI connector is used to output video from Lyft to an external display. International HDMI standards are applied.

Table A-5 HDMI connector data

Type	HDMI, female
Manufacturer P/N	Tyco Electronics 2007435-1
Eddyfi P/N	MACN4039

Table A-6 HDMI connector pinout

Pin	Signal	Description
1	TMDS Data2+	Transition minimized differential signaling (TMDS) positive data 2
2	TMDS Data2 Shield	TMDS data 2 shield
3	TMDS Data2-	TMDS negative data 2
4	TMDS Data1+	TMDS positive data 1
5	TMDS Data1 Shield	TMDS data 1 shield
6	TMDS Data1-	TMDS negative data 1
7	TMDS Data0+	TMDS positive data 0
8	TMDS Data0 Shield	TMDS data 0 shield
9	TMDS Data0-	TMDS negative data 0
10	TMDS Clock+	TMDS positive clock
11	TMDS Clock Shield	TMDS clock shield
12	TMDS Clock-	TMDS negative clock
13	NC	Not connected
14	NC	Not connected
15	SCL	I ² C serial clock for data display channel (DDC)
16	SDA	I ² C serial data line for DDC

17	DDC/CEC/ARC/HEC Ground	Grounds for DDC, CEC,ARC, and HEC
18	+5V	5V supply (maximum 0.05A)
19	Hot Plug Detect	Hot plug detection pin

USB Connectors

The USB connectors support USB 2.0. You can use the USB connectors to connect USB-compliant devices to Lyft, including external memory, mouse, and keyboard. International USB 2.0 standards are applied.

Table A-7 USB connector data

Pin	Signal	Description
1	VCC	5V supply
2	D-	Data-
3	D+	Data+
4	GND	Ground
Type	USB, female	
Manufacturer P/N	FCi 73725-0110BLF	
Eddyfi P/N	MACN4038	

Table A-8 USB connector pinout

Audio Jack

Table A-9 Audio jack data

Type	3.5 mm audio jack, female
Manufacturer P/N	FCUI SJI-3514-SMT-TR
Eddyfi P/N	MACN4048

Table A-10 Audio jack pinout

Pin	Signal	Description
1	GND	Ground
2	Left	Left channel
3	Right	Right channel

Appendix B

Using the Optional Harness

Adjusting the Harness

Harnessing Lyft® requires several specific adjustments so that you feel comfortable wearing the harness.

Adjusting the Harness to your Body

- I. Grab the harness shoulder straps and slip it over your shoulders as you would a jacket.

Figure B-1 Slipping the harness on

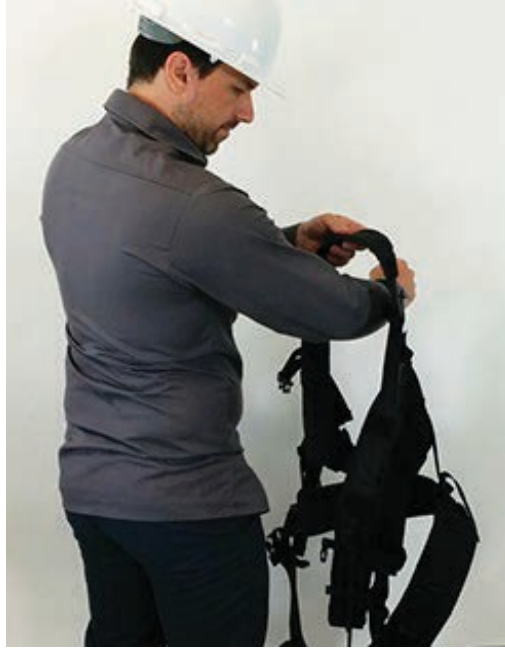

2. Verify the fit of the harness.
Visualize working with Lyft before making any adjustments to the shoulder straps and height of the belt.
3. Slip out of the harness.
4. Use the underarm straps and shoulder blade rings to adjust the fit of your shoulder straps. You may need to perform this adjustment several times to get the proper fit.

Figure B-2 Adjusting the shoulder straps



5. Use the back and side belt straps to adjust the height of the harness's belt to suit your body type. You may need to perform this adjustment several times to get the proper fit.

Note

Your belt's height determines the lowest position of Lyft. Adjust this height so that the display of the instrument is easy to see for that, the belt could end up higher than your hips.

Figure B-3 Adjusting the belt's height



6. Once your belt and shoulder straps are adjusted, clip and tighten the chest straps.

Figure B-4 Securing the chest straps



7. Secure the belt around your waist, according to the height you have adjusted it.

Figure B-5 Securing the belt



8. Make sure that the harness fits snugly.
9. Make sure that the harness's shoulder anchor straps are loose.

Figure B-6 Shoulder anchor straps



- 10.** Unfasten the two straps at each end of the shoulder anchor straps. Place them within hands reach. You will need them.

Figure B-7 Unfastening the straps



- 11.** Sit down.
- 12.** Place Lyft horizontally in your lap.
- 13.** Slip the looped portion of the strap removed above in the hook of one of the two upper Lyft bumpers, as illustrated.

Note

Illustrated here is [Reddy](#). Manipulations on Lyft are the same.

Figure B-8 Sliding strap loop through bumper hook



14. Slip the clip through the strap hoop, and then pull to tighten into place, as illustrated.

Figure B-9 Securing anchor strap



15. Repeat the previous two steps for the opposite upper bumper.

Note

You can also secure the straps to the bumpers in a more elegant and less easy-to-remove fashion, as illustrated here.

Figure B-10 Alternative method of securing anchor strap to bumper



16. Locate the anchor strap on the harness's belt.

Figure B-11 Anchor strap on harness belt



17. Open the battery compartment door and slip the male buckle of the anchor strap, as illustrated.

Figure B-12 Slipping male buckle through bumper



18. Mate the male buckle to its female counterpart.

Figure B-13 Mating battery compartment side anchor strap



19. Close and secure the battery compartment door.

Figure B-14 Closing battery compartment door.



- 20.** Repeat the procedure for the opposite belt anchor strap (no door to open).
- 21.** Adjust the length of the anchor straps until comfortable.
- 22.** Mate the left male buckle of the shoulder anchor strap to its female counterpart.

Figure B-15 Mating shoulder anchor strap



- 23.** Repeat for the opposite shoulder anchor strap.
- 24.** Tighten each shoulder anchor straps to achieve the desired view angle for Lyft.

Figure B-16 Tightening shoulder anchor straps

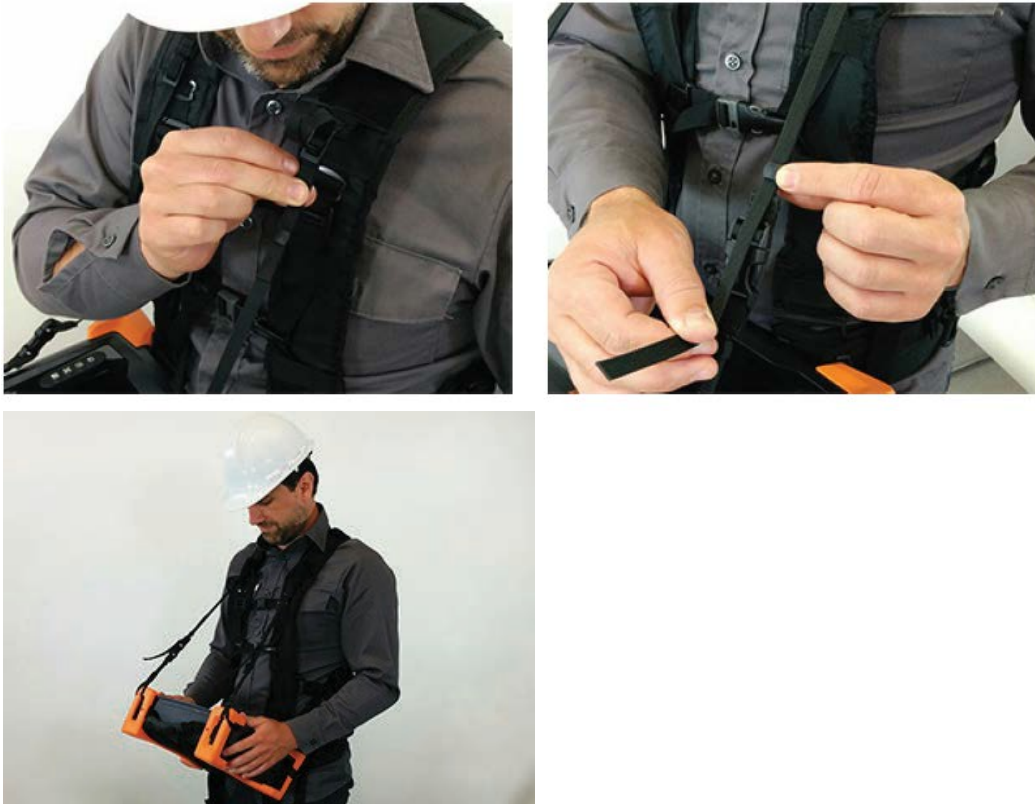

Note

Use the belt strap to hook your probe's cable.

Figure B-17 Belt-slinging probe cable



Appendix C

Setting Up the Extension Pole

Setting Up the Extension Pole

The optional extension pole enables you to use Lyft® in hard-to-reach locations. Proceed as follows to ready the system for operation.

Installing the Extension Pole Supports on the PEC Probe

1. Locate the pocket on the side of the side of the extension pole carrying case.
2. From the pocket, remove the supports, screws, and tools.
3. According to the size of the probe you are using, select the appropriate supports. There are two supports per probe size.

Figure C-1 PEC probe supports and screws



4. Place the probe on one side, and then align the support screw holes with those on the probe.
5. Using the supplied thumb screws, secure the support to the side of the probe.

Figure C-2 Securing supports to PEC probe



6. Repeat for the second support on the opposite side of the probe.

Installing the PEC Probe on the Extension Pole

1. Slide the probe through the extension pole's head as illustrated.

Figure C-3 Sliding PEC probe on extension pole head



2. Align the screw holes of the pole's head with the ones on the supports on the PEC probe.
3. Using the supplied screws, secure the probe to the pole's head.

Figure C-4 Securing PEC probe to extension pole head



4. Release the topmost portion of the extension pole by pulling the latch.
5. Extend the topmost portion of the pole slightly.
6. Close the latch to secure the extension pole.

Connecting the Extension Pole to Lyft

- I. Run the PEC probe connector and cable through the three hoops on the pole, as illustrated.

Figure C-5 Running PEC probe cable through pole hoops



2. Connect the probe cable connector to the remote control on the pole. Make sure that the connector clicks in place.

Figure C-6 Connecting PEC probe connector to extension pole remote control



- 3.** Connect the remote-control connector to the Lyft PEC connector.

Appendix D

Using the array probe straps

Locking and unlocking the probe curvature

The array probe curvature can be adjusted to fit on flat surfaces and pipes down to 6 inches outside diameter. The locking mechanism allows you to fix the curvature on the component and ensure a constant fit.

Unlocking the probe curvature

- 1. Locate the 6 locking latches on the probe, 3 on each side

Figure D-1 Locked latches



- 2. Open all of the 6 latches

Figure D-2 Unlocked latches



Fitting and locking the probe in position

1. Lay the unlocked probe on a pipe
2. Lock the 6 probe latches delicately.
3. Validate that the encoder wheel is in contact with the component

Figure D-3 Probe on a pipe with curvature locked



To ease the inspection of pipes, install the carriage accessories and close the strap loops.

Installing the carriages

1. Insert the straps inside the channels of the carriages. The Carriage position on the strap may be adjusted later on.

Figure D-4 Carriage installed on straps



2. Connect the end of the strap loops to the buckles on the other end of the probe

Figure D-5 Strap connected to the probe buckles



2. Adjust the position of the carriages on the strap to limit the contact between the straps and the surface
3. Tighten the straps to ensure full support of the probe. Do not over tighten the straps, to prevent damaging the weather jacket.

Installing the Grid-As-U-Go™ system

1. Install the handle on the module of the element that is ahead in the index direction. Refer to training material for further details on probe positioning and scan or index direction.

Figure D-6 Handle installed on element 6



2. Install the marker/pen of your choice in the Grid-As-U-Go system.

Figure D-7 Erasable marker installed



3. Install the Grid-As-U-Go system on the probe handle accessory previously installed.

Figure D-8 Grid-As-U-Go the PECA probe



4. Remove the marker/pen cap and adjust the pen position in the system using the clamping screw to ensure proper contact on the component surface.

Figure D-9 Installed Grid-As-U-Go



Appendix E

License management

Lyft Go

Activate your Go Subscription

At least, at renewal, your Lyft unit needs to be connected to the licensing system over internet.

To do so, you need to connect an ethernet cable or connect your Lyft to internet via Wi-Fi.

Lyft Pro

Request temporary license

At activation of Lyft 2.3 or later version, a pop-up window requiring an activation code will appear. To request an activation code, you can request a temporary license and fill all necessary information.

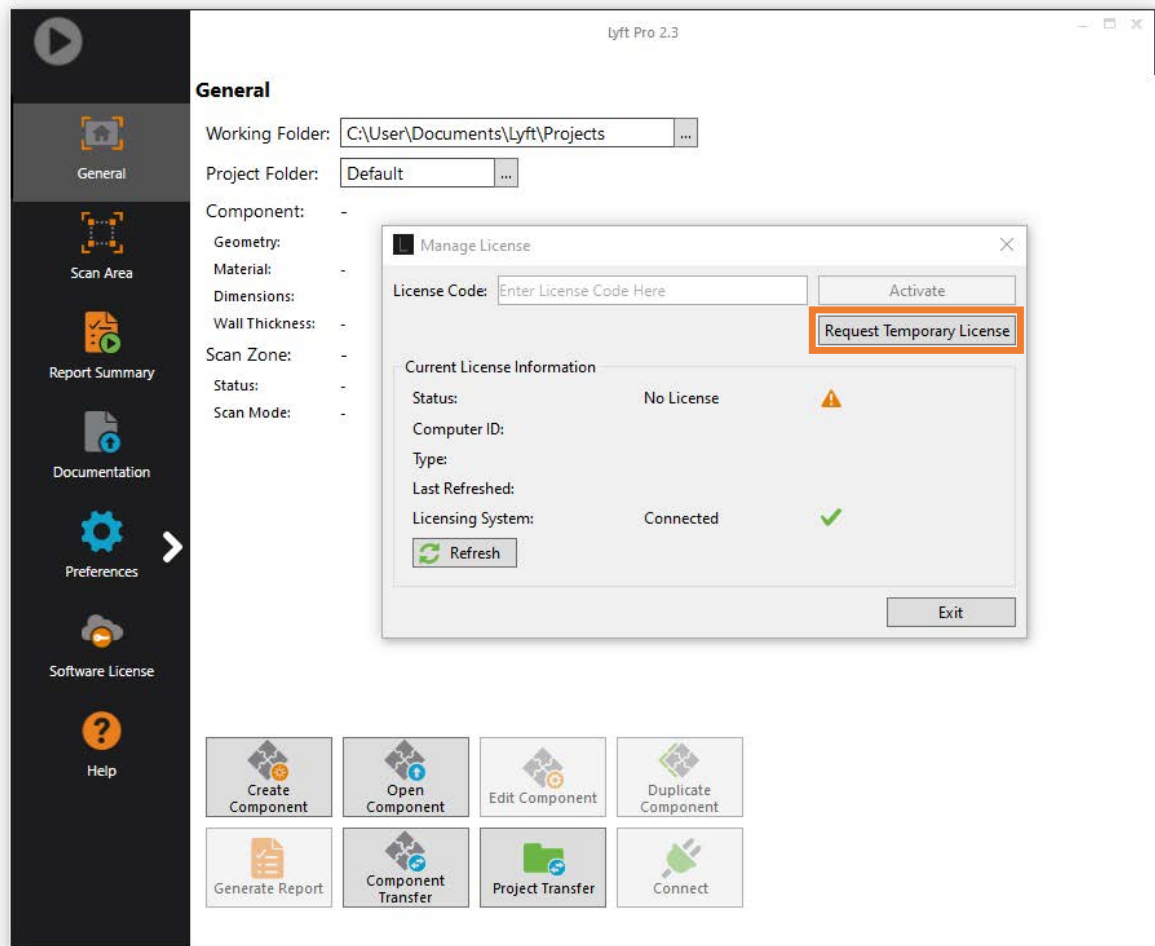

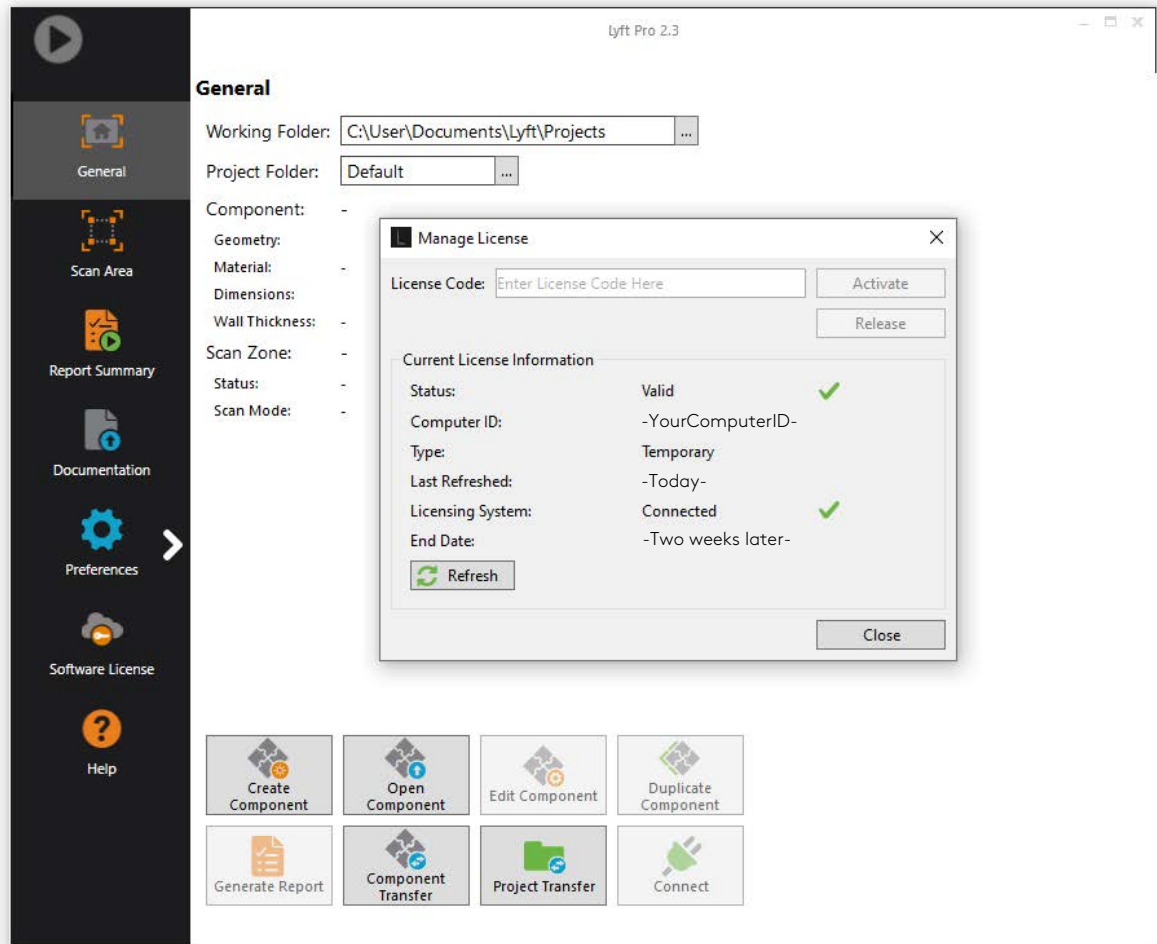

Activation of license

At any time during and after the temporary license period, you can activate your license code provided by your Eddyfi Representative.

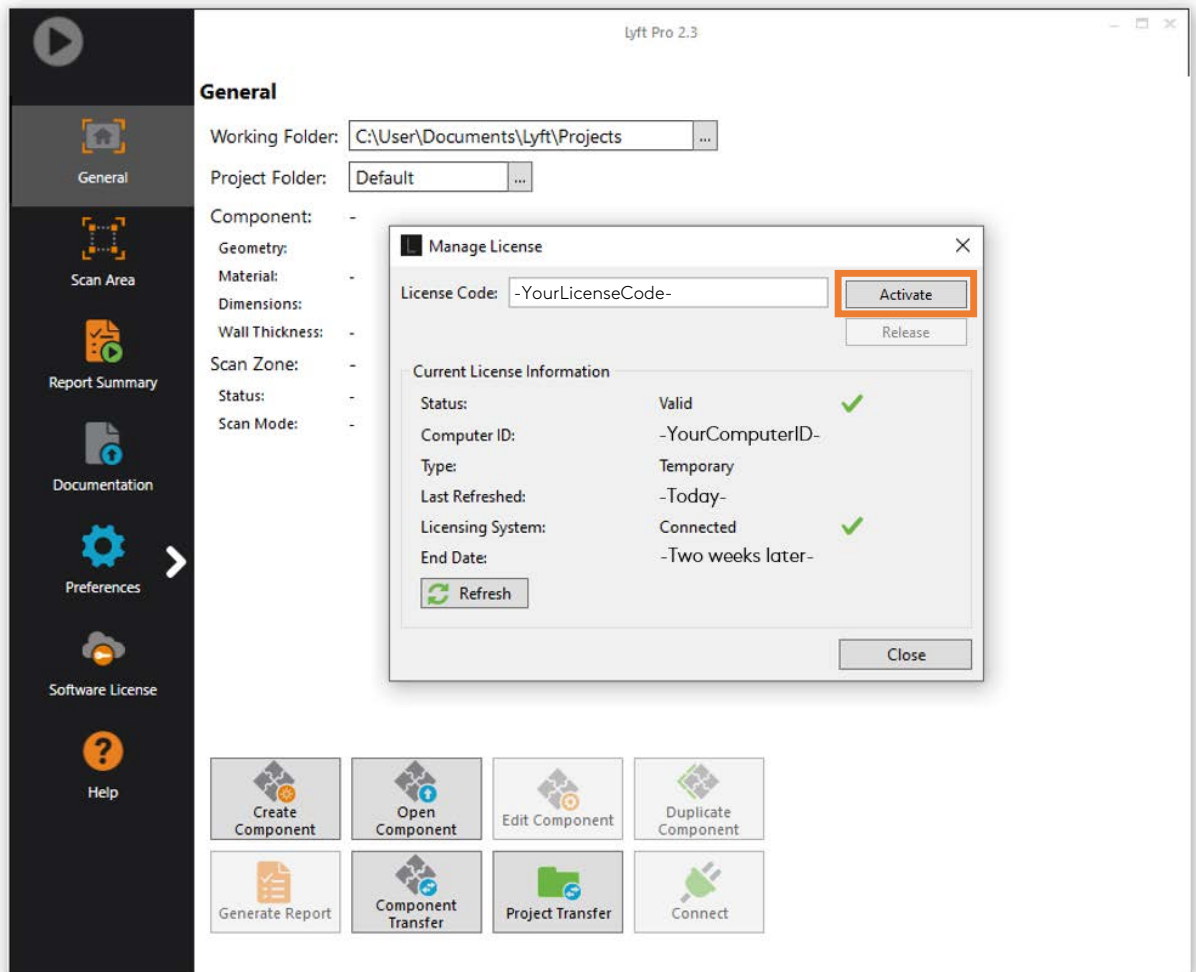

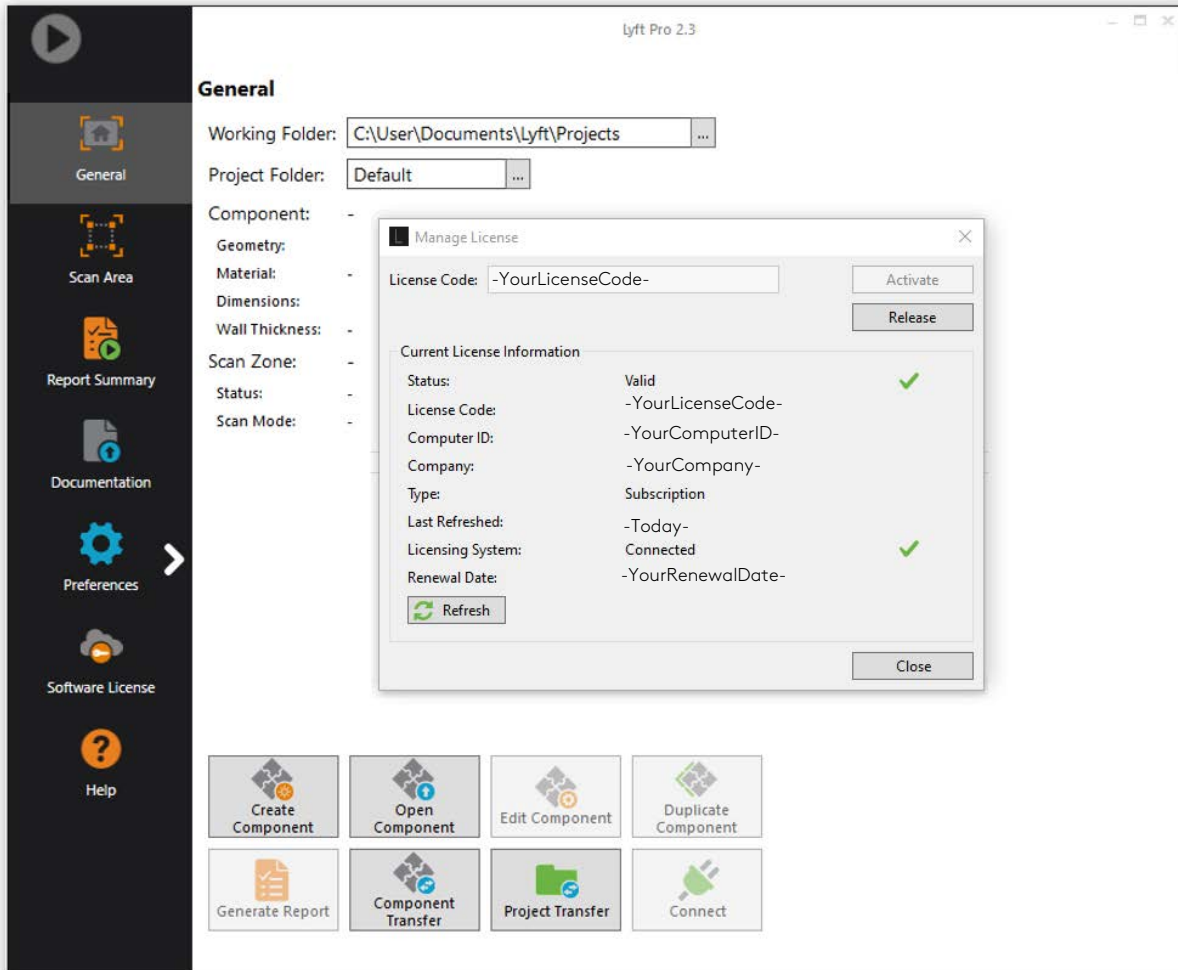

Release of license

To release a license (to share it with a colleague or to change computer), you need to release it. To release it, you only need to click on the “Release button”. Once a license is released, the software cannot be used until reactivation. The last activation code is kept in memory.